

# R&S® AMU200A

## Baseband Signal Generator and Fading Simulator

### Operating Manual



1402.5222.32 – 10

This document describes the R&S®AMU200A, stock no. 1402.4090.02 and its options.

- R&S®AMU-B9/-B10/-B11
- R&S®AMU-B13
- R&S®AMU-B16
- R&S®AMU-B17
- R&S®AMU-B18
- R&S®AMU-B81
- R&S®AMU-K61
- R&S®AMU-K62
- R&S®AMU-K80

This manual describes firmware version FW 3.20.286.xxx and later of the R&S®SMU200A, R&S®SMATE200A, R&S®SMJ100A and R&S®AMU200A.

© 2016 Rohde & Schwarz GmbH & Co. KG  
Mühlhofstr. 15, 81671 München, Germany  
Phone: +49 89 41 29 - 0  
Fax: +49 89 41 29 12 164

Email: [info@rohde-schwarz.com](mailto:info@rohde-schwarz.com)

Internet: [www.rohde-schwarz.com](http://www.rohde-schwarz.com)

Subject to change – Data without tolerance limits is not binding.

R&S® is a registered trademark of Rohde & Schwarz GmbH & Co. KG.

Trade names are trademarks of the owners.

The following abbreviations are used throughout this manual: R&S®AMU200A is abbreviated as R&S AMU, R&S®WinIQSIM2™ is abbreviated as R&S WinIQSIM2, R&S®EX-IQ-BOX is abbreviated as R&S EX-IQ-BOX.

# Basic Safety Instructions

## Always read through and comply with the following safety instructions!

All plants and locations of the Rohde & Schwarz group of companies make every effort to keep the safety standards of our products up to date and to offer our customers the highest possible degree of safety. Our products and the auxiliary equipment they require are designed, built and tested in accordance with the safety standards that apply in each case. Compliance with these standards is continuously monitored by our quality assurance system. The product described here has been designed, built and tested in accordance with the EC Certificate of Conformity and has left the manufacturer's plant in a condition fully complying with safety standards. To maintain this condition and to ensure safe operation, you must observe all instructions and warnings provided in this manual. If you have any questions regarding these safety instructions, the Rohde & Schwarz group of companies will be happy to answer them.

Furthermore, it is your responsibility to use the product in an appropriate manner. This product is designed for use solely in industrial and laboratory environments or, if expressly permitted, also in the field and must not be used in any way that may cause personal injury or property damage. You are responsible if the product is used for any purpose other than its designated purpose or in disregard of the manufacturer's instructions. The manufacturer shall assume no responsibility for such use of the product.

The product is used for its designated purpose if it is used in accordance with its product documentation and within its performance limits (see data sheet, documentation, the following safety instructions). Using the product requires technical skills and, in some cases, a basic knowledge of English. It is therefore essential that only skilled and specialized staff or thoroughly trained personnel with the required skills be allowed to use the product. If personal safety gear is required for using Rohde & Schwarz products, this will be indicated at the appropriate place in the product documentation. Keep the basic safety instructions and the product documentation in a safe place and pass them on to the subsequent users.

Observing the safety instructions will help prevent personal injury or damage of any kind caused by dangerous situations. Therefore, carefully read through and adhere to the following safety instructions before and when using the product. It is also absolutely essential to observe the additional safety instructions on personal safety, for example, that appear in relevant parts of the product documentation. In these safety instructions, the word "product" refers to all merchandise sold and distributed by the Rohde & Schwarz group of companies, including instruments, systems and all accessories. For product-specific information, see the data sheet and the product documentation.

## Safety labels on products

The following safety labels are used on products to warn against risks and dangers.

Symbol	Meaning	Symbol	Meaning
	Notice, general danger location Observe product documentation		ON/OFF Power
	Caution when handling heavy equipment		Standby indication
	Danger of electric shock		Direct current (DC)

## Basic Safety Instructions

Symbol	Meaning	Symbol	Meaning
	Caution ! Hot surface		Alternating current (AC)
	Protective conductor terminal To identify any terminal which is intended for connection to an external conductor for protection against electric shock in case of a fault, or the terminal of a protective earth		Direct/alternating current (DC/AC)
	Earth (Ground)		Class II Equipment to identify equipment meeting the safety requirements specified for Class II equipment (device protected by double or reinforced insulation)
	Frame or chassis Ground terminal		EU labeling for batteries and accumulators For additional information, see section "Waste disposal/Environmental protection", item 1.
	Be careful when handling electrostatic sensitive devices		EU labeling for separate collection of electrical and electronic devices For additional information, see section "Waste disposal/Environmental protection", item 2.
	Warning! Laser radiation For additional information, see section "Operation", item 7.		

### Signal words and their meaning

The following signal words are used in the product documentation in order to warn the reader about risks and dangers.



Indicates a hazardous situation which, if not avoided, will result in death or serious injury.



Indicates a hazardous situation which, if not avoided, could result in death or serious injury.



Indicates a hazardous situation which, if not avoided, could result in minor or moderate injury.



Indicates information considered important, but not hazard-related, e.g. messages relating to property damage.  
In the product documentation, the word ATTENTION is used synonymously.

These signal words are in accordance with the standard definition for civil applications in the European Economic Area. Definitions that deviate from the standard definition may also exist in other economic areas or military applications. It is therefore essential to make sure that the signal words described here are always used only in connection with the related product documentation and the related product. The use of signal words in connection with unrelated products or documentation can result in misinterpretation and in personal injury or material damage.



## Basic Safety Instructions

### Operating states and operating positions

*The product may be operated only under the operating conditions and in the positions specified by the manufacturer, without the product's ventilation being obstructed. If the manufacturer's specifications are not observed, this can result in electric shock, fire and/or serious personal injury or death. Applicable local or national safety regulations and rules for the prevention of accidents must be observed in all work performed.*

1. Unless otherwise specified, the following requirements apply to Rohde & Schwarz products: predefined operating position is always with the housing floor facing down, IP protection 2X, use only indoors, max. operating altitude 2000 m above sea level, max. transport altitude 4500 m above sea level. A tolerance of  $\pm 10\%$  shall apply to the nominal voltage and  $\pm 5\%$  to the nominal frequency, overvoltage category 2, pollution degree 2.
2. Do not place the product on surfaces, vehicles, cabinets or tables that for reasons of weight or stability are unsuitable for this purpose. Always follow the manufacturer's installation instructions when installing the product and fastening it to objects or structures (e.g. walls and shelves). An installation that is not carried out as described in the product documentation could result in personal injury or even death.
3. Do not place the product on heat-generating devices such as radiators or fan heaters. The ambient temperature must not exceed the maximum temperature specified in the product documentation or in the data sheet. Product overheating can cause electric shock, fire and/or serious personal injury or even death.

### Electrical safety

*If the information on electrical safety is not observed either at all or to the extent necessary, electric shock, fire and/or serious personal injury or death may occur.*

1. Prior to switching on the product, always ensure that the nominal voltage setting on the product matches the nominal voltage of the mains-supply network. If a different voltage is to be set, the power fuse of the product may have to be changed accordingly.
2. In the case of products of safety class I with movable power cord and connector, operation is permitted only on sockets with a protective conductor contact and protective conductor.
3. Intentionally breaking the protective conductor either in the feed line or in the product itself is not permitted. Doing so can result in the danger of an electric shock from the product. If extension cords or connector strips are implemented, they must be checked on a regular basis to ensure that they are safe to use.
4. If there is no power switch for disconnecting the product from the mains, or if the power switch is not suitable for this purpose, use the plug of the connecting cable to disconnect the product from the mains. In such cases, always ensure that the power plug is easily reachable and accessible at all times. For example, if the power plug is the disconnecting device, the length of the connecting cable must not exceed 3 m. Functional or electronic switches are not suitable for providing disconnection from the AC supply network. If products without power switches are integrated into racks or systems, the disconnecting device must be provided at the system level.
5. Never use the product if the power cable is damaged. Check the power cables on a regular basis to ensure that they are in proper operating condition. By taking appropriate safety measures and carefully laying the power cable, ensure that the cable cannot be damaged and that no one can be hurt by, for example, tripping over the cable or suffering an electric shock.

## Basic Safety Instructions

6. The product may be operated only from TN/TT supply networks fuse-protected with max. 16 A (higher fuse only after consulting with the Rohde & Schwarz group of companies).
7. Do not insert the plug into sockets that are dusty or dirty. Insert the plug firmly and all the way into the socket provided for this purpose. Otherwise, sparks that result in fire and/or injuries may occur.
8. Do not overload any sockets, extension cords or connector strips; doing so can cause fire or electric shocks.
9. For measurements in circuits with voltages  $V_{rms} > 30$  V, suitable measures (e.g. appropriate measuring equipment, fuse protection, current limiting, electrical separation, insulation) should be taken to avoid any hazards.
10. Ensure that the connections with information technology equipment, e.g. PCs or other industrial computers, comply with the IEC 60950-1 / EN 60950-1 or IEC 61010-1 / EN 61010-1 standards that apply in each case.
11. Unless expressly permitted, never remove the cover or any part of the housing while the product is in operation. Doing so will expose circuits and components and can lead to injuries, fire or damage to the product.
12. If a product is to be permanently installed, the connection between the protective conductor terminal on site and the product's protective conductor must be made first before any other connection is made. The product may be installed and connected only by a licensed electrician.
13. For permanently installed equipment without built-in fuses, circuit breakers or similar protective devices, the supply circuit must be fuse-protected in such a way that anyone who has access to the product, as well as the product itself, is adequately protected from injury or damage.
14. Use suitable overvoltage protection to ensure that no overvoltage (such as that caused by a bolt of lightning) can reach the product. Otherwise, the person operating the product will be exposed to the danger of an electric shock.
15. Any object that is not designed to be placed in the openings of the housing must not be used for this purpose. Doing so can cause short circuits inside the product and/or electric shocks, fire or injuries.
16. Unless specified otherwise, products are not liquid-proof (see also section "Operating states and operating positions", item 1). Therefore, the equipment must be protected against penetration by liquids. If the necessary precautions are not taken, the user may suffer electric shock or the product itself may be damaged, which can also lead to personal injury.
17. Never use the product under conditions in which condensation has formed or can form in or on the product, e.g. if the product has been moved from a cold to a warm environment. Penetration by water increases the risk of electric shock.
18. Prior to cleaning the product, disconnect it completely from the power supply (e.g. AC supply network or battery). Use a soft, non-linting cloth to clean the product. Never use chemical cleaning agents such as alcohol, acetone or diluents for cellulose lacquers.

## Operation

1. Operating the products requires special training and intense concentration. Make sure that persons who use the products are physically, mentally and emotionally fit enough to do so; otherwise, injuries or material damage may occur. It is the responsibility of the employer/operator to select suitable personnel for operating the products.

## Basic Safety Instructions

2. Before you move or transport the product, read and observe the section titled "Transport".
3. As with all industrially manufactured goods, the use of substances that induce an allergic reaction (allergens) such as nickel cannot be generally excluded. If you develop an allergic reaction (such as a skin rash, frequent sneezing, red eyes or respiratory difficulties) when using a Rohde & Schwarz product, consult a physician immediately to determine the cause and to prevent health problems or stress.
4. Before you start processing the product mechanically and/or thermally, or before you take it apart, be sure to read and pay special attention to the section titled "Waste disposal/Environmental protection", item 1.
5. Depending on the function, certain products such as RF radio equipment can produce an elevated level of electromagnetic radiation. Considering that unborn babies require increased protection, pregnant women must be protected by appropriate measures. Persons with pacemakers may also be exposed to risks from electromagnetic radiation. The employer/operator must evaluate workplaces where there is a special risk of exposure to radiation and, if necessary, take measures to avert the potential danger.
6. Should a fire occur, the product may release hazardous substances (gases, fluids, etc.) that can cause health problems. Therefore, suitable measures must be taken, e.g. protective masks and protective clothing must be worn.
7. Laser products are given warning labels that are standardized according to their laser class. Lasers can cause biological harm due to the properties of their radiation and due to their extremely concentrated electromagnetic power. If a laser product (e.g. a CD/DVD drive) is integrated into a Rohde & Schwarz product, absolutely no other settings or functions may be used as described in the product documentation. The objective is to prevent personal injury (e.g. due to laser beams).
8. EMC classes (in line with EN 55011/CISPR 11, and analogously with EN 55022/CISPR 22, EN 55032/CISPR 32)
  - Class A equipment:  
Equipment suitable for use in all environments except residential environments and environments that are directly connected to a low-voltage supply network that supplies residential buildings  
Note: Class A equipment is intended for use in an industrial environment. This equipment may cause radio disturbances in residential environments, due to possible conducted as well as radiated disturbances. In this case, the operator may be required to take appropriate measures to eliminate these disturbances.
  - Class B equipment:  
Equipment suitable for use in residential environments and environments that are directly connected to a low-voltage supply network that supplies residential buildings

### Repair and service

1. The product may be opened only by authorized, specially trained personnel. Before any work is performed on the product or before the product is opened, it must be disconnected from the AC supply network. Otherwise, personnel will be exposed to the risk of an electric shock.

## Basic Safety Instructions

- Adjustments, replacement of parts, maintenance and repair may be performed only by electrical experts authorized by Rohde & Schwarz. Only original parts may be used for replacing parts relevant to safety (e.g. power switches, power transformers, fuses). A safety test must always be performed after parts relevant to safety have been replaced (visual inspection, protective conductor test, insulation resistance measurement, leakage current measurement, functional test). This helps ensure the continued safety of the product.

### Batteries and rechargeable batteries/cells

*If the information regarding batteries and rechargeable batteries/cells is not observed either at all or to the extent necessary, product users may be exposed to the risk of explosions, fire and/or serious personal injury, and, in some cases, death. Batteries and rechargeable batteries with alkaline electrolytes (e.g. lithium cells) must be handled in accordance with the EN 62133 standard.*

- Cells must not be taken apart or crushed.
- Cells or batteries must not be exposed to heat or fire. Storage in direct sunlight must be avoided. Keep cells and batteries clean and dry. Clean soiled connectors using a dry, clean cloth.
- Cells or batteries must not be short-circuited. Cells or batteries must not be stored in a box or in a drawer where they can short-circuit each other, or where they can be short-circuited by other conductive materials. Cells and batteries must not be removed from their original packaging until they are ready to be used.
- Cells and batteries must not be exposed to any mechanical shocks that are stronger than permitted.
- If a cell develops a leak, the fluid must not be allowed to come into contact with the skin or eyes. If contact occurs, wash the affected area with plenty of water and seek medical aid.
- Improperly replacing or charging cells or batteries that contain alkaline electrolytes (e.g. lithium cells) can cause explosions. Replace cells or batteries only with the matching Rohde & Schwarz type (see parts list) in order to ensure the safety of the product.
- Cells and batteries must be recycled and kept separate from residual waste. Rechargeable batteries and normal batteries that contain lead, mercury or cadmium are hazardous waste. Observe the national regulations regarding waste disposal and recycling.

### Transport

- The product may be very heavy. Therefore, the product must be handled with care. In some cases, the user may require a suitable means of lifting or moving the product (e.g. with a lift-truck) to avoid back or other physical injuries.
- Handles on the products are designed exclusively to enable personnel to transport the product. It is therefore not permissible to use handles to fasten the product to or on transport equipment such as cranes, fork lifts, wagons, etc. The user is responsible for securely fastening the products to or on the means of transport or lifting. Observe the safety regulations of the manufacturer of the means of transport or lifting. Noncompliance can result in personal injury or material damage.
- If you use the product in a vehicle, it is the sole responsibility of the driver to drive the vehicle safely and properly. The manufacturer assumes no responsibility for accidents or collisions. Never use the product in a moving vehicle if doing so could distract the driver of the vehicle. Adequately secure the product in the vehicle to prevent injuries or other damage in the event of an accident.

## Instrucciones de seguridad elementales

### Waste disposal/Environmental protection

1. Specially marked equipment has a battery or accumulator that must not be disposed of with unsorted municipal waste, but must be collected separately. It may only be disposed of at a suitable collection point or via a Rohde & Schwarz customer service center.
2. Waste electrical and electronic equipment must not be disposed of with unsorted municipal waste, but must be collected separately.  
Rohde & Schwarz GmbH & Co. KG has developed a disposal concept and takes full responsibility for take-back obligations and disposal obligations for manufacturers within the EU. Contact your Rohde & Schwarz customer service center for environmentally responsible disposal of the product.
3. If products or their components are mechanically and/or thermally processed in a manner that goes beyond their intended use, hazardous substances (heavy-metal dust such as lead, beryllium, nickel) may be released. For this reason, the product may only be disassembled by specially trained personnel. Improper disassembly may be hazardous to your health. National waste disposal regulations must be observed.
4. If handling the product releases hazardous substances or fuels that must be disposed of in a special way, e.g. coolants or engine oils that must be replenished regularly, the safety instructions of the manufacturer of the hazardous substances or fuels and the applicable regional waste disposal regulations must be observed. Also observe the relevant safety instructions in the product documentation. The improper disposal of hazardous substances or fuels can cause health problems and lead to environmental damage.

For additional information about environmental protection, visit the Rohde & Schwarz website.

## Instrucciones de seguridad elementales

### **¡Es imprescindible leer y cumplir las siguientes instrucciones e informaciones de seguridad!**

El principio del grupo de empresas Rohde & Schwarz consiste en tener nuestros productos siempre al día con los estándares de seguridad y de ofrecer a nuestros clientes el máximo grado de seguridad. Nuestros productos y todos los equipos adicionales son siempre fabricados y examinados según las normas de seguridad vigentes. Nuestro sistema de garantía de calidad controla constantemente que sean cumplidas estas normas. El presente producto ha sido fabricado y examinado según el certificado de conformidad de la UE y ha salido de nuestra planta en estado impecable según los estándares técnicos de seguridad. Para poder preservar este estado y garantizar un funcionamiento libre de peligros, el usuario deberá atenerse a todas las indicaciones, informaciones de seguridad y notas de alerta. El grupo de empresas Rohde & Schwarz está siempre a su disposición en caso de que tengan preguntas referentes a estas informaciones de seguridad.

Además queda en la responsabilidad del usuario utilizar el producto en la forma debida. Este producto está destinado exclusivamente al uso en la industria y el laboratorio o, si ha sido expresamente autorizado, para aplicaciones de campo y de ninguna manera deberá ser utilizado de modo que alguna persona/cosa pueda sufrir daño. El uso del producto fuera de sus fines definidos o sin tener en cuenta las instrucciones del fabricante queda en la responsabilidad del usuario. El fabricante no se hace en ninguna forma responsable de consecuencias a causa del mal uso del producto.















## Instrucciones de seguridad elementales

Se parte del uso correcto del producto para los fines definidos si el producto es utilizado conforme a las indicaciones de la correspondiente documentación del producto y dentro del margen de rendimiento definido (ver hoja de datos, documentación, informaciones de seguridad que siguen). El uso del producto hace necesarios conocimientos técnicos y ciertos conocimientos del idioma inglés. Por eso se debe tener en cuenta que el producto solo pueda ser operado por personal especializado o personas instruidas en profundidad con las capacidades correspondientes. Si fuera necesaria indumentaria de seguridad para el uso de productos de Rohde & Schwarz, encontraría la información debida en la documentación del producto en el capítulo correspondiente. Guarde bien las informaciones de seguridad elementales, así como la documentación del producto, y entréguelas a usuarios posteriores.



Tener en cuenta las informaciones de seguridad sirve para evitar en lo posible lesiones o daños por peligros de toda clase. Por eso es imprescindible leer detalladamente y comprender por completo las siguientes informaciones de seguridad antes de usar el producto, y respetarlas durante el uso del producto. Deberán tenerse en cuenta todas las demás informaciones de seguridad, como p. ej. las referentes a la protección de personas, que encontrarán en el capítulo correspondiente de la documentación del producto y que también son de obligado cumplimiento. En las presentes informaciones de seguridad se recogen todos los objetos que distribuye el grupo de empresas Rohde & Schwarz bajo la denominación de "producto", entre ellos también aparatos, instalaciones así como toda clase de accesorios. Los datos específicos del producto figuran en la hoja de datos y en la documentación del producto.

### Señalización de seguridad de los productos

Las siguientes señales de seguridad se utilizan en los productos para advertir sobre riesgos y peligros.

Símbolo	Significado	Símbolo	Significado
	Aviso: punto de peligro general Observar la documentación del producto		Tensión de alimentación de PUESTA EN MARCHA / PARADA
	Atención en el manejo de dispositivos de peso elevado		Indicación de estado de espera (standby)
	Peligro de choque eléctrico		Corriente continua (DC)
	Advertencia: superficie caliente		Corriente alterna (AC)
	Conexión a conductor de protección		Corriente continua / Corriente alterna (DC/AC)
	Conexión a tierra		El aparato está protegido en su totalidad por un aislamiento doble (reforzado)
	Conexión a masa		Distintivo de la UE para baterías y acumuladores  Más información en la sección "Eliminación/protección del medio ambiente", punto 1.

## Instrucciones de seguridad elementales

Símbolo	Significado	Símbolo	Significado
	Aviso: Cuidado en el manejo de dispositivos sensibles a la electrostática (ESD)		Distintivo de la UE para la eliminación por separado de dispositivos eléctricos y electrónicos  Más información en la sección "Eliminación/protección del medio ambiente", punto 2.
	Advertencia: rayo láser  Más información en la sección "Funcionamiento", punto 7.		

### Palabras de señal y su significado

En la documentación del producto se utilizan las siguientes palabras de señal con el fin de advertir contra riesgos y peligros.



Indica una situación de peligro que, si no se evita, causa lesiones graves o incluso la muerte.



Indica una situación de peligro que, si no se evita, puede causar lesiones graves o incluso la muerte.



Indica una situación de peligro que, si no se evita, puede causar lesiones leves o moderadas.



Indica información que se considera importante, pero no en relación con situaciones de peligro; p. ej., avisos sobre posibles daños materiales.

En la documentación del producto se emplea de forma sinónima el término CUIDADO.

Las palabras de señal corresponden a la definición habitual para aplicaciones civiles en el área económica europea. Pueden existir definiciones diferentes a esta definición en otras áreas económicas o en aplicaciones militares. Por eso se deberá tener en cuenta que las palabras de señal aquí descritas sean utilizadas siempre solamente en combinación con la correspondiente documentación del producto y solamente en combinación con el producto correspondiente. La utilización de las palabras de señal en combinación con productos o documentaciones que no les correspondan puede llevar a interpretaciones equivocadas y tener por consecuencia daños en personas u objetos.

### Estados operativos y posiciones de funcionamiento

*El producto solamente debe ser utilizado según lo indicado por el fabricante respecto a los estados operativos y posiciones de funcionamiento sin que se obstruya la ventilación. Si no se siguen las indicaciones del fabricante, pueden producirse choques eléctricos, incendios y/o lesiones graves con posible consecuencia de muerte. En todos los trabajos deberán ser tenidas en cuenta las normas nacionales y locales de seguridad del trabajo y de prevención de accidentes.*



## Instrucciones de seguridad elementales

1. Si no se convino de otra manera, es para los productos Rohde & Schwarz válido lo que sigue: como posición de funcionamiento se define por principio la posición con el suelo de la caja para abajo, modo de protección IP 2X, uso solamente en estancias interiores, utilización hasta 2000 m sobre el nivel del mar, transporte hasta 4500 m sobre el nivel del mar. Se aplicará una tolerancia de  $\pm 10\%$  sobre el voltaje nominal y de  $\pm 5\%$  sobre la frecuencia nominal. Categoría de sobrecarga eléctrica 2, índice de suciedad 2.
2. No sitúe el producto encima de superficies, vehículos, estantes o mesas, que por sus características de peso o de estabilidad no sean aptos para él. Siga siempre las instrucciones de instalación del fabricante cuando instale y asegure el producto en objetos o estructuras (p. ej. paredes y estantes). Si se realiza la instalación de modo distinto al indicado en la documentación del producto, se pueden causar lesiones o, en determinadas circunstancias, incluso la muerte.
3. No ponga el producto sobre aparatos que generen calor (p. ej. radiadores o calefactores). La temperatura ambiente no debe superar la temperatura máxima especificada en la documentación del producto o en la hoja de datos. En caso de sobrecalentamiento del producto, pueden producirse choques eléctricos, incendios y/o lesiones graves con posible consecuencia de muerte.

### Seguridad eléctrica

*Si no se siguen (o se siguen de modo insuficiente) las indicaciones del fabricante en cuanto a seguridad eléctrica, pueden producirse choques eléctricos, incendios y/o lesiones graves con posible consecuencia de muerte.*

1. Antes de la puesta en marcha del producto se deberá comprobar siempre que la tensión preseleccionada en el producto coincida con la de la red de alimentación eléctrica. Si es necesario modificar el ajuste de tensión, también se deberán cambiar en caso dado los fusibles correspondientes del producto.
2. Los productos de la clase de protección I con alimentación móvil y enchufe individual solamente podrán enchufarse a tomas de corriente con contacto de seguridad y con conductor de protección conectado.
3. Queda prohibida la interrupción intencionada del conductor de protección, tanto en la toma de corriente como en el mismo producto. La interrupción puede tener como consecuencia el riesgo de que el producto sea fuente de choques eléctricos. Si se utilizan cables alargadores o regletas de enchufe, deberá garantizarse la realización de un examen regular de los mismos en cuanto a su estado técnico de seguridad.
4. Si el producto no está equipado con un interruptor para desconectarlo de la red, o bien si el interruptor existente no resulta apropiado para la desconexión de la red, el enchufe del cable de conexión se deberá considerar como un dispositivo de desconexión. El dispositivo de desconexión se debe poder alcanzar fácilmente y debe estar siempre bien accesible. Si, p. ej., el enchufe de conexión a la red es el dispositivo de desconexión, la longitud del cable de conexión no debe superar 3 m). Los interruptores selectores o electrónicos no son aptos para el corte de la red eléctrica. Si se integran productos sin interruptor en bastidores o instalaciones, se deberá colocar el interruptor en el nivel de la instalación.
5. No utilice nunca el producto si está dañado el cable de conexión a red. Compruebe regularmente el correcto estado de los cables de conexión a red. Asegúrese, mediante las medidas de protección y de instalación adecuadas, de que el cable de conexión a red no pueda ser dañado o de que nadie pueda ser dañado por él, p. ej. al tropezar o por un choque eléctrico.

## Instrucciones de seguridad elementales

6. Solamente está permitido el funcionamiento en redes de alimentación TN/TT aseguradas con fusibles de 16 A como máximo (utilización de fusibles de mayor amperaje solo previa consulta con el grupo de empresas Rohde & Schwarz).
7. Nunca conecte el enchufe en tomas de corriente sucias o llenas de polvo. Introduzca el enchufe por completo y fuertemente en la toma de corriente. La no observación de estas medidas puede provocar chispas, fuego y/o lesiones.
8. No sobrecargue las tomas de corriente, los cables alargadores o las regletas de enchufe ya que esto podría causar fuego o choques eléctricos.
9. En las mediciones en circuitos de corriente con una tensión  $U_{\text{eff}} > 30 \text{ V}$  se deberán tomar las medidas apropiadas para impedir cualquier peligro (p. ej. medios de medición adecuados, seguros, limitación de tensión, corte protector, aislamiento etc.).
10. Para la conexión con dispositivos informáticos como un PC o un ordenador industrial, debe comprobarse que éstos cumplan los estándares IEC60950-1/EN60950-1 o IEC61010-1/EN 61010-1 válidos en cada caso.
11. A menos que esté permitido expresamente, no retire nunca la tapa ni componentes de la carcasa mientras el producto esté en servicio. Esto pone a descubierto los cables y componentes eléctricos y puede causar lesiones, fuego o daños en el producto.
12. Si un producto se instala en un lugar fijo, se deberá primero conectar el conductor de protección fijo con el conductor de protección del producto antes de hacer cualquier otra conexión. La instalación y la conexión deberán ser efectuadas por un electricista especializado.
13. En el caso de dispositivos fijos que no estén provistos de fusibles, interruptor automático ni otros mecanismos de seguridad similares, el circuito de alimentación debe estar protegido de modo que todas las personas que puedan acceder al producto, así como el producto mismo, estén a salvo de posibles daños.
14. Todo producto debe estar protegido contra sobretensión (debida p. ej. a una caída del rayo) mediante los correspondientes sistemas de protección. Si no, el personal que lo utilice quedará expuesto al peligro de choque eléctrico.
15. No debe introducirse en los orificios de la caja del aparato ningún objeto que no esté destinado a ello. Esto puede producir cortocircuitos en el producto y/o puede causar choques eléctricos, fuego o lesiones.
16. Salvo indicación contraria, los productos no están impermeabilizados (ver también el capítulo "Estados operativos y posiciones de funcionamiento", punto 1). Por eso es necesario tomar las medidas necesarias para evitar la entrada de líquidos. En caso contrario, existe peligro de choque eléctrico para el usuario o de daños en el producto, que también pueden redundar en peligro para las personas.
17. No utilice el producto en condiciones en las que pueda producirse o ya se hayan producido condensaciones sobre el producto o en el interior de éste, como p. ej. al desplazarlo de un lugar frío a otro caliente. La entrada de agua aumenta el riesgo de choque eléctrico.
18. Antes de la limpieza, desconecte por completo el producto de la alimentación de tensión (p. ej. red de alimentación o batería). Realice la limpieza de los aparatos con un paño suave, que no se deshilache. No utilice bajo ningún concepto productos de limpieza químicos como alcohol, acetona o diluyentes para lacas nitrocelulósicas.

## Instrucciones de seguridad elementales

### Funcionamiento

1. El uso del producto requiere instrucciones especiales y una alta concentración durante el manejo. Debe asegurarse que las personas que manejen el producto estén a la altura de los requerimientos necesarios en cuanto a aptitudes físicas, psíquicas y emocionales, ya que de otra manera no se pueden excluir lesiones o daños de objetos. El empresario u operador es responsable de seleccionar el personal usuario apto para el manejo del producto.
2. Antes de desplazar o transportar el producto, lea y tenga en cuenta el capítulo "Transporte".
3. Como con todo producto de fabricación industrial no puede quedar excluida en general la posibilidad de que se produzcan alergias provocadas por algunos materiales empleados —los llamados alérgenos (p. ej. el níquel)—. Si durante el manejo de productos Rohde & Schwarz se producen reacciones alérgicas, como p. ej. irritaciones cutáneas, estornudos continuos, enrojecimiento de la conjuntiva o dificultades respiratorias, debe avisarse inmediatamente a un médico para investigar las causas y evitar cualquier molestia o daño a la salud.
4. Antes de la manipulación mecánica y/o térmica o el desmontaje del producto, debe tenerse en cuenta imprescindiblemente el capítulo "Eliminación/protección del medio ambiente", punto 1.
5. Ciertos productos, como p. ej. las instalaciones de radiocomunicación RF, pueden a causa de su función natural, emitir una radiación electromagnética aumentada. Deben tomarse todas las medidas necesarias para la protección de las mujeres embarazadas. También las personas con marcapasos pueden correr peligro a causa de la radiación electromagnética. El empresario/operador tiene la obligación de evaluar y señalar las áreas de trabajo en las que exista un riesgo elevado de exposición a radiaciones.
6. Tenga en cuenta que en caso de incendio pueden desprenderse del producto sustancias tóxicas (gases, líquidos etc.) que pueden generar daños a la salud. Por eso, en caso de incendio deben usarse medidas adecuadas, como p. ej. máscaras antigás e indumentaria de protección.
7. Los productos con láser están provistos de indicaciones de advertencia normalizadas en función de la clase de láser del que se trate. Los rayos láser pueden provocar daños de tipo biológico a causa de las propiedades de su radiación y debido a su concentración extrema de potencia electromagnética. En caso de que un producto Rohde & Schwarz contenga un producto láser (p. ej. un lector de CD/DVD), no debe usarse ninguna otra configuración o función aparte de las descritas en la documentación del producto, a fin de evitar lesiones (p. ej. debidas a irradiación láser).
8. Clases de compatibilidad electromagnética (conforme a EN 55011 / CISPR 11; y en analogía con EN 55022 / CISPR 22, EN 55032 / CISPR 32)
  - Aparato de clase A:  
Aparato adecuado para su uso en todos los entornos excepto en los residenciales y en aquellos conectados directamente a una red de distribución de baja tensión que suministra corriente a edificios residenciales.  
Nota: Los aparatos de clase A están destinados al uso en entornos industriales. Estos aparatos pueden causar perturbaciones radioeléctricas en entornos residenciales debido a posibles perturbaciones guiadas o radiadas. En este caso, se le podrá solicitar al operador que tome las medidas adecuadas para eliminar estas perturbaciones.
  - Aparato de clase B:  
Aparato adecuado para su uso en entornos residenciales, así como en aquellos conectados directamente a una red de distribución de baja tensión que suministra corriente a edificios residenciales.

## Instrucciones de seguridad elementales

### Reparación y mantenimiento

1. El producto solamente debe ser abierto por personal especializado con autorización para ello. Antes de manipular el producto o abrirlo, es obligatorio desconectarlo de la tensión de alimentación, para evitar toda posibilidad de choque eléctrico.
2. El ajuste, el cambio de partes, el mantenimiento y la reparación deberán ser efectuadas solamente por electricistas autorizados por Rohde & Schwarz. Si se reponen partes con importancia para los aspectos de seguridad (p. ej. el enchufe, los transformadores o los fusibles), solamente podrán ser sustituidos por partes originales. Después de cada cambio de partes relevantes para la seguridad deberá realizarse un control de seguridad (control a primera vista, control del conductor de protección, medición de resistencia de aislamiento, medición de la corriente de fuga, control de funcionamiento). Con esto queda garantizada la seguridad del producto.

### Baterías y acumuladores o celdas

*Si no se siguen (o se siguen de modo insuficiente) las indicaciones en cuanto a las baterías y acumuladores o celdas, pueden producirse explosiones, incendios y/o lesiones graves con posible consecuencia de muerte. El manejo de baterías y acumuladores con electrolitos alcalinos (p. ej. celdas de litio) debe seguir el estándar EN 62133.*

1. No deben desmontarse, abrirse ni triturarse las celdas.
2. Las celdas o baterías no deben someterse a calor ni fuego. Debe evitarse el almacenamiento a la luz directa del sol. Las celdas y baterías deben mantenerse limpias y secas. Limpiar las conexiones sucias con un paño seco y limpio.
3. Las celdas o baterías no deben cortocircuitarse. Es peligroso almacenar las celdas o baterías en estuches o cajones en cuyo interior puedan cortocircuitarse por contacto recíproco o por contacto con otros materiales conductores. No deben extraerse las celdas o baterías de sus embalajes originales hasta el momento en que vayan a utilizarse.
4. Las celdas o baterías no deben someterse a impactos mecánicos fuertes indebidos.
5. En caso de falta de estanqueidad de una celda, el líquido vertido no debe entrar en contacto con la piel ni los ojos. Si se produce contacto, lavar con agua abundante la zona afectada y avisar a un médico.
6. En caso de cambio o recarga inadecuados, las celdas o baterías que contienen electrolitos alcalinos (p. ej. las celdas de litio) pueden explotar. Para garantizar la seguridad del producto, las celdas o baterías solo deben ser sustituidas por el tipo Rohde & Schwarz correspondiente (ver lista de recambios).
7. Las baterías y celdas deben reciclarse y no deben tirarse a la basura doméstica. Las baterías o acumuladores que contienen plomo, mercurio o cadmio deben tratarse como residuos especiales. Respete en esta relación las normas nacionales de eliminación y reciclaje.

### Transporte

1. El producto puede tener un peso elevado. Por eso es necesario desplazarlo o transportarlo con precaución y, si es necesario, usando un sistema de elevación adecuado (p. ej. una carretilla elevadora), a fin de evitar lesiones en la espalda u otros daños personales.

## Instrucciones de seguridad elementales

2. Las asas instaladas en los productos sirven solamente de ayuda para el transporte del producto por personas. Por eso no está permitido utilizar las asas para la sujeción en o sobre medios de transporte como p. ej. grúas, carretillas elevadoras de horquilla, carros etc. Es responsabilidad suya fijar los productos de manera segura a los medios de transporte o elevación. Para evitar daños personales o daños en el producto, siga las instrucciones de seguridad del fabricante del medio de transporte o elevación utilizado.
3. Si se utiliza el producto dentro de un vehículo, recae de manera exclusiva en el conductor la responsabilidad de conducir el vehículo de manera segura y adecuada. El fabricante no asumirá ninguna responsabilidad por accidentes o colisiones. No utilice nunca el producto dentro de un vehículo en movimiento si esto pudiera distraer al conductor. Asegure el producto dentro del vehículo debidamente para evitar, en caso de un accidente, lesiones u otra clase de daños.

### Eliminación/protección del medio ambiente

1. Los dispositivos marcados contienen una batería o un acumulador que no se debe desechar con los residuos domésticos sin clasificar, sino que debe ser recogido por separado. La eliminación se debe efectuar exclusivamente a través de un punto de recogida apropiado o del servicio de atención al cliente de Rohde & Schwarz.
2. Los dispositivos eléctricos usados no se deben desechar con los residuos domésticos sin clasificar, sino que deben ser recogidos por separado.  
Rohde & Schwarz GmbH & Co.KG ha elaborado un concepto de eliminación de residuos y asume plenamente los deberes de recogida y eliminación para los fabricantes dentro de la UE. Para desechar el producto de manera respetuosa con el medio ambiente, dirijase a su servicio de atención al cliente de Rohde & Schwarz.
3. Si se trabaja de manera mecánica y/o térmica cualquier producto o componente más allá del funcionamiento previsto, pueden liberarse sustancias peligrosas (polvos con contenido de metales pesados como p. ej. plomo, berilio o níquel). Por eso el producto solo debe ser desmontado por personal especializado con formación adecuada. Un desmontaje inadecuado puede ocasionar daños para la salud. Se deben tener en cuenta las directivas nacionales referentes a la eliminación de residuos.
4. En caso de que durante el trato del producto se formen sustancias peligrosas o combustibles que deban tratarse como residuos especiales (p. ej. refrigerantes o aceites de motor con intervalos de cambio definidos), deben tenerse en cuenta las indicaciones de seguridad del fabricante de dichas sustancias y las normas regionales de eliminación de residuos. Tenga en cuenta también en caso necesario las indicaciones de seguridad especiales contenidas en la documentación del producto. La eliminación incorrecta de sustancias peligrosas o combustibles puede causar daños a la salud o daños al medio ambiente.

Se puede encontrar más información sobre la protección del medio ambiente en la página web de Rohde & Schwarz.

# Quality management and environmental management

Certified Quality System  
**ISO 9001**

Certified Environmental System  
**ISO 14001**

## Sehr geehrter Kunde,

Sie haben sich für den Kauf eines Rohde&Schwarz Produktes entschieden. Sie erhalten damit ein nach modernsten Fertigungsmethoden hergestelltes Produkt. Es wurde nach den Regeln unserer Qualitäts- und Umweltmanagementsysteme entwickelt, gefertigt und geprüft. Rohde&Schwarz ist unter anderem nach den Managementsystemen ISO9001 und ISO 14001 zertifiziert.

## Der Umwelt verpflichtet

- Energie-effiziente, RoHS-konforme Produkte
- Kontinuierliche Weiterentwicklung nachhaltiger Umweltkonzepte
- ISO 14001-zertifiziertes Umweltmanagementsystem

## Dear customer,

You have decided to buy a Rohde&Schwarz product. This product has been manufactured using the most advanced methods. It was developed, manufactured and tested in compliance with our quality management and environmental management systems. Rohde&Schwarz has been certified, for example, according to the ISO9001 and ISO 14001 management systems.

## Environmental commitment

- Energy-efficient products
- Continuous improvement in environmental sustainability
- ISO 14001-certified environmental management system

## Cher client,

Vous avez choisi d'acheter un produit Rohde&Schwarz. Vous disposez donc d'un produit fabriqué d'après les méthodes les plus avancées. Le développement, la fabrication et les tests de ce produit ont été effectués selon nos systèmes de management de qualité et de management environnemental. La société Rohde&Schwarz a été homologuée, entre autres, conformément aux systèmes de management ISO9001 et ISO 14001.

## Engagement écologique

- Produits à efficience énergétique
- Amélioration continue de la durabilité environnementale
- Système de management environnemental certifié selon ISO 14001



# Customer Support

## Technical support – where and when you need it

For quick, expert help with any Rohde & Schwarz equipment, contact one of our Customer Support Centers. A team of highly qualified engineers provides telephone support and will work with you to find a solution to your query on any aspect of the operation, programming or applications of Rohde & Schwarz equipment.

## Up-to-date information and upgrades

To keep your instrument up-to-date and to be informed about new application notes related to your instrument, please send an e-mail to the Customer Support Center stating your instrument and your wish. We will take care that you will get the right information.

### Europe, Africa, Middle East

Phone +49 89 4129 12345  
[customersupport@rohde-schwarz.com](mailto:customersupport@rohde-schwarz.com)

### North America

Phone 1-888-TEST-RSA (1-888-837-8772)  
[customer.support@rsa.rohde-schwarz.com](mailto:customer.support@rsa.rohde-schwarz.com)

### Latin America

Phone +1-410-910-7988  
[customersupport.la@rohde-schwarz.com](mailto:customersupport.la@rohde-schwarz.com)

### Asia/Pacific

Phone +65 65 13 04 88  
[customersupport.asia@rohde-schwarz.com](mailto:customersupport.asia@rohde-schwarz.com)

### China

Phone +86-800-810-8228 /  
+86-400-650-5896  
[customersupport.china@rohde-schwarz.com](mailto:customersupport.china@rohde-schwarz.com)





# Contents

<b>1</b>	<b>Preface</b> .....	<b>15</b>
1.1	Documentation Overview.....	15
1.2	Typographical Conventions.....	16
1.3	Notes on Screenshots.....	17
<b>2</b>	<b>Preparing for Use</b> .....	<b>19</b>
2.1	Front Panel Tour.....	19
2.1.1	Utility Keys.....	20
2.1.2	Standby LEDs and Standby Key.....	20
2.1.3	Display.....	21
2.1.4	Setup Keys.....	21
2.1.4.1	Keys for Setting Parameters.....	21
2.1.4.2	Display Keys.....	22
2.1.5	Keypad for data entry.....	23
2.1.6	Rotary Knob and Navigation Keys.....	24
2.1.7	Front Panel Connectors.....	25
2.2	Rear Panel Tour.....	26
2.2.1	Description of the Connectors.....	27
2.3	Putting into Operation.....	32
2.3.1	EMI Suppression.....	33
2.3.2	Unpacking and Checking the Instrument.....	34
2.3.3	Placing or Mounting the Instrument.....	34
2.3.4	Connecting the Instrument to the AC Supply.....	36
2.3.5	Starting the Instrument.....	36
2.3.5.1	Standby and Ready state.....	37
2.3.5.2	Start Display and Booting.....	37
2.3.5.3	Function Check.....	37
2.3.5.4	Default Settings.....	38
2.3.6	Shutting Down the Instrument.....	39
2.4	Connecting External Accessories.....	39
2.4.1	Connecting USB Devices.....	40
2.4.2	Connecting a Monitor.....	41

<b>2.5</b>	<b>Windows Operating System.....</b>	<b>42</b>
2.5.1	Virus Protection.....	42
2.5.2	Service Packs and Updates.....	43
2.5.3	Login.....	43
2.5.4	Accessing the Start Menu.....	43
<b>2.6</b>	<b>Setting Up a Network (LAN) Connection.....</b>	<b>43</b>
2.6.1	Connecting the Instrument to the Network.....	44
2.6.2	Assigning the IP Address.....	45
2.6.3	Using computer names.....	46
2.6.4	Changing the Windows Firewall Settings.....	46
2.6.5	Working with Directories.....	47
<b>2.7</b>	<b>Remote Access via an External Controller.....</b>	<b>48</b>
2.7.1	Using a Web Browser for Remote Access.....	49
2.7.2	Remote Desktop Connection.....	50
2.7.3	Remote Access via a VNC Client Software.....	53
<b>2.8</b>	<b>Using Virus-Protection Software.....</b>	<b>59</b>
<b>2.9</b>	<b>LXI Configuration.....</b>	<b>60</b>
2.9.1	LXI Browser Settings.....	62
2.9.2	LAN Configuration.....	64
2.9.2.1	IP Configuration.....	64
2.9.2.2	Advanced LAN Configuration.....	65
2.9.2.3	Ping Client.....	66
2.9.2.4	Web Control.....	67
2.9.2.5	SCPI Remote Trace.....	68
<b>3</b>	<b>Getting Started.....</b>	<b>71</b>
<b>3.1</b>	<b>Brief Introduction to the Instrument's Concept.....</b>	<b>71</b>
<b>3.2</b>	<b>Applications of the Instrument.....</b>	<b>73</b>
3.2.1	Generation of Digitally Modulated Signals.....	74
3.2.2	One Path Instrument.....	76
3.2.3	Two Path Instrument.....	77
<b>3.3</b>	<b>Baseband Section.....</b>	<b>78</b>
3.3.1	Description of Individual Diagram Blocks of the Baseband Section.....	80
<b>3.4</b>	<b>Example of Setup.....</b>	<b>82</b>

<b>4</b>	<b>Manual Operation.....</b>	<b>95</b>
<b>4.1</b>	<b>Key Features.....</b>	<b>95</b>
<b>4.2</b>	<b>Display.....</b>	<b>100</b>
4.2.1	Settings Displayed in the Header Section.....	100
4.2.2	Status Information and Messages.....	101
4.2.2.1	Status Information.....	101
4.2.2.2	Messages.....	101
4.2.2.3	Volatile messages.....	101
4.2.2.4	Permanent Messages.....	102
4.2.3	Info Window.....	102
4.2.4	Block Diagram .....	103
4.2.4.1	Function Blocks in the Block Diagram.....	104
4.2.4.2	Signal Flow and Input/Output Symbols in the Block Diagram.....	104
4.2.5	Winbar and Softkeys.....	105
4.2.6	Structure of the Dialogs.....	105
4.2.7	Graphical Display of Output Signal Characteristics.....	106
<b>4.3</b>	<b>Accessing Dialogs.....</b>	<b>107</b>
<b>4.4</b>	<b>Setting Parameters.....</b>	<b>108</b>
4.4.1	Working with the Cursor.....	109
4.4.2	Selecting a Control Element.....	110
4.4.3	Switching Parameters On/Off.....	110
4.4.4	Entering a Value.....	110
4.4.5	Working with Units .....	112
4.4.6	Selecting a Value from a List.....	113
4.4.7	Terminating Entries with Confirmation.....	113
4.4.8	Restoring the Previous Value.....	114
<b>4.5</b>	<b>Editors.....</b>	<b>115</b>
4.5.1	Working with Data Editor.....	116
4.5.2	Working with Control and Marker List Editor.....	117
<b>4.6</b>	<b>How to Use the Help System.....</b>	<b>121</b>
<b>4.7</b>	<b>File Management.....</b>	<b>123</b>
4.7.1	File Select Dialog.....	124
4.7.2	File Manager.....	126

4.7.2.1	Extensions for User Files.....	127
<b>4.8</b>	<b>Legend of Front-Panel Controls.....</b>	<b>129</b>
4.8.1	Front Panel Key Emulation.....	131
4.8.2	On-screen Keyboard.....	131
<b>5</b>	<b>Instrument Function.....</b>	<b>133</b>
<b>5.1</b>	<b>Overview of Instrument Functions.....</b>	<b>133</b>
<b>5.2</b>	<b>General Instrument Settings.....</b>	<b>135</b>
5.2.1	Overview of General Instrument Settings.....	135
5.2.2	Default Instrument Settings - Preset Key.....	136
5.2.3	General Configuration of Instrument - Setup Key.....	137
5.2.3.1	Reference Oscillator.....	137
5.2.3.2	Internal Adjustments.....	140
5.2.3.3	Hardware Config.....	142
5.2.3.4	Software / Options.....	143
5.2.3.5	Manage License Keys.....	144
5.2.3.6	Update.....	146
5.2.3.7	Display Update.....	146
5.2.3.8	Check Front Panel.....	147
5.2.3.9	Global Trigger/Clock/External Input Settings.....	148
5.2.3.10	Display/Keyboard Settings.....	150
5.2.3.11	User Marker / AUX I/O Settings.....	151
5.2.3.12	Remote Channel Settings.....	155
5.2.3.13	LXI Status.....	156
5.2.3.14	Protection.....	157
5.2.3.15	Security.....	158
5.2.3.16	Save/Recall.....	161
5.2.3.17	Factory Preset.....	161
5.2.3.18	Help.....	161
5.2.4	Switching to Manual Control - Local Key.....	162
5.2.5	Generating a Hard Copy of the Display.....	163
5.2.5.1	Hard Copy Settings.....	163
5.2.5.2	Hardcopy Options.....	164
5.2.6	Messages - Info Key.....	166

5.2.7	Help System - Help Key.....	166
5.2.8	Storing and Loading Instrument Data - File Key.....	167
5.2.8.1	Save/Recall Menu.....	168
5.2.8.2	Storing Instrument Settings.....	168
5.2.8.3	Loading Instrument Settings.....	170
5.2.8.4	File Select Dialog.....	172
5.2.8.5	File Manager.....	174
5.2.8.6	Accessing the File System of the Instrument and Transferring Files from and to the Instrument.....	176
<b>5.3</b>	<b>Graphical Display - Graphics.....</b>	<b>177</b>
5.3.1	Graphics Settings Menu.....	178
5.3.2	Bar of Graphics Window.....	181
5.3.3	Signal Displays.....	183
5.3.3.1	I/Q Diagram.....	183
5.3.3.2	Vector Diagram.....	184
5.3.3.3	Constellation Diagram.....	185
5.3.3.4	Eye Diagram.....	186
5.3.3.5	CCDF Display.....	187
5.3.3.6	Power Spectrum.....	188
<b>5.4</b>	<b>Bit and Block Error Rate Measurements - BERT Block.....</b>	<b>189</b>
5.4.1	Test setup.....	190
5.4.2	PRBS data.....	190
5.4.3	CRC polynomial.....	191
5.4.4	Clock signal.....	191
5.4.5	Ending the measurement.....	191
5.4.6	Interrupt-free measurement.....	192
5.4.7	Restart function.....	192
5.4.8	Data Enable.....	193
5.4.9	Pattern Ignore.....	193
5.4.10	Bit Error Rate Menu.....	194
5.4.10.1	General Settings.....	195
5.4.10.2	Configuration.....	198
5.4.11	Block Error Rate Menu.....	202
5.4.11.1	General Settings.....	203

5.4.11.2	Configuration.....	205
<b>5.5</b>	<b>Output of Digital and Analog Baseband Signal - I/Q Out.....</b>	<b>208</b>
5.5.1	Switching I/Q Out On/Off.....	209
5.5.2	Level Display Settings.....	210
5.5.3	Analog I/Q Output Settings.....	212
5.5.4	Digital I/Q Output Settings.....	217
5.5.4.1	Digital I/Q Output General Settings.....	218
5.5.4.2	Sample Rate.....	218
5.5.4.3	Signal Output.....	219
5.5.4.4	User Variation.....	220
5.5.4.5	Signal Monitoring.....	221
5.5.4.6	Power On Settings.....	221
<b>5.6</b>	<b>Impairment of Digital I/Q Signal and Noise Generator - AWGN/IMP Block.....</b>	<b>222</b>
5.6.1	Impairments.....	223
5.6.1.1	Gain and Gain Imbalance.....	223
5.6.1.2	I and Q Offset.....	224
5.6.1.3	Quadrature Offset.....	224
5.6.1.4	Impairment Settings Menu.....	225
5.6.2	AWGN - Noise Generator.....	226
5.6.2.1	AWGN Settings Dialog.....	227
5.6.3	I/Q Level - Info.....	232
5.6.3.1	Baseband Signal Level.....	233
5.6.3.2	Baseband Signal Power Measurement.....	234
<b>5.7</b>	<b>Baseband Signal - Baseband Block.....</b>	<b>235</b>
5.7.1	Working with the Baseband Signal.....	236
5.7.2	Data and Signal Sources in Baseband.....	242
5.7.2.1	Internal PRBS Data and Data Patterns.....	243
5.7.2.2	Internal Modulation Data from Lists.....	243
5.7.2.3	External Synchronous Modulation Data.....	244
5.7.2.4	Clock Signals.....	245
5.7.2.5	Synchronizing Data Signals and Clock Signals.....	246
5.7.2.6	Control Signals.....	249
5.7.2.7	Trigger Signals.....	252

5.7.2.8	Marker Output Signals.....	253
5.7.3	Digital Modulation - Custom Digital Modulation.....	255
5.7.3.1	Overview and Required Options.....	255
5.7.3.2	Modulation Types - Custom Digital Mod.....	256
5.7.3.3	Coding - Custom Digital Mod.....	260
5.7.3.4	Baseband Filter - Custom Digital Mod.....	263
5.7.3.5	Conflicting Settings - Custom Digital Mod.....	267
5.7.3.6	Custom Digital Mod User Interface.....	267
5.7.4	Arbitrary Waveform Generator ARB.....	296
5.7.4.1	Introduction.....	297
5.7.4.2	ARB User Interface.....	302
5.7.4.3	Multi Segment Waveforms.....	324
5.7.4.4	Multi Carrier Waveforms.....	341
5.7.5	Multi Carrier Continuous Wave.....	354
5.7.5.1	Multi Carrier CW User Interface.....	354
<b>5.8</b>	<b>External Baseband Signal - Baseband Input.....</b>	<b>367</b>
5.8.1	Important Signal Parameters.....	368
5.8.2	BB Input Block.....	370
5.8.2.1	Baseband Input Settings Menu.....	370
5.8.2.2	Signal Routing and Frequency Shifting.....	376
<b>6</b>	<b>Remote Control Basics.....</b>	<b>381</b>
<b>6.1</b>	<b>Remote Control Interfaces and Protocols.....</b>	<b>381</b>
6.1.1	VISA Libraries.....	382
6.1.2	Messages.....	382
6.1.3	LAN Interface.....	383
6.1.3.1	HiSLIP Protocol.....	385
6.1.3.2	VXI-11 Protocol.....	385
6.1.3.3	Socket Communication.....	385
6.1.3.4	LAN Interface Messages.....	386
6.1.4	GPIB Interface (IEC/IEEE Bus Interface).....	386
6.1.4.1	GPIB Interface Messages.....	387
6.1.4.2	GPIB Instrument Address.....	388
6.1.5	LXI Browser Interface.....	388



<b>6.2</b>	<b>Starting a Remote Control Session.....</b>	<b>388</b>
6.2.1	Switching to Remote Control.....	389
6.2.2	Returning to Manual Operation.....	390
6.2.3	Examples.....	391
6.2.3.1	Remote Control over GPIB.....	391
6.2.3.2	Remote Control over LAN using VXI-11 Protocol.....	392
6.2.3.3	Remote Control over LAN using Socket Communication.....	397
<b>6.3</b>	<b>SCPI Command Structure.....</b>	<b>404</b>
6.3.1	Syntax for Common Commands.....	404
6.3.2	Syntax for Device-Specific Commands.....	405
6.3.3	SCPI Parameters.....	407
6.3.4	Overview of Syntax Elements.....	410
6.3.5	Structure of a command line.....	410
6.3.6	Responses to Queries.....	411
<b>6.4</b>	<b>Command Sequence and Synchronization.....</b>	<b>412</b>
6.4.1	Preventing Overlapping Execution.....	414
<b>6.5</b>	<b>Status Reporting System.....</b>	<b>415</b>
6.5.1	Hierarchy of the Status Registers.....	416
6.5.2	Structure of a SCPI Status Register.....	417
6.5.3	Status Byte (STB) and Service Request Enable Register (SRE).....	419
6.5.4	Event Status Register (ESR) and Event Status Enable Register (ESE).....	420
6.5.5	Questionable Status Register (STATus:QUESTionable).....	421
6.5.6	Operation Status Register (STATus:OPERation).....	421
6.5.7	Application of the Status Reporting System.....	422
6.5.7.1	Service Request.....	422
6.5.7.2	Serial Poll.....	422
6.5.7.3	Query of an instrument status.....	423
6.5.7.4	Error Queue.....	423
6.5.8	Reset Values of the Status Reporting System.....	423
<b>6.6</b>	<b>General Programming Recommendations.....</b>	<b>424</b>
<b>7</b>	<b>Remote Control Commands.....</b>	<b>425</b>
<b>7.1</b>	<b>Conventions used in SCPI Command Descriptions.....</b>	<b>425</b>
<b>7.2</b>	<b>Common Commands.....</b>	<b>425</b>

<b>7.3</b>	<b>Preset Commands</b> .....	<b>430</b>
<b>7.4</b>	<b>Waveform and List Format</b> .....	<b>432</b>
7.4.1	Tag Description.....	432
7.4.2	How to Define Periodically Repeating Traces.....	445
7.4.3	How to Manually Create a Waveform Using Tag File Format.....	447
7.4.4	Creating an ASCII C-List Manually.....	451
7.4.5	Editing Waveform Files, Data and Control Lists.....	453
<b>7.5</b>	<b>BERT and BLER Subsystems</b> .....	<b>453</b>
<b>7.6</b>	<b>CALibration Subsystem</b> .....	<b>463</b>
<b>7.7</b>	<b>CLOCK Subsystem</b> .....	<b>465</b>
<b>7.8</b>	<b>DIAGnostic Subsystem</b> .....	<b>466</b>
<b>7.9</b>	<b>DISPlay Subsystem</b> .....	<b>468</b>
<b>7.10</b>	<b>FORMat Subsystem</b> .....	<b>471</b>
<b>7.11</b>	<b>HCOPY Subsystem</b> .....	<b>473</b>
<b>7.12</b>	<b>KBOARD Subsystem</b> .....	<b>482</b>
<b>7.13</b>	<b>MMEMory Subsystem</b> .....	<b>483</b>
7.13.1	File Naming Conventions.....	483
7.13.2	Extensions for User Files.....	484
7.13.3	Examples.....	486
7.13.4	Remote Control Commands.....	488
<b>7.14</b>	<b>OUTPut Subsystem</b> .....	<b>494</b>
<b>7.15</b>	<b>SOURce Subsystem</b> .....	<b>495</b>
7.15.1	SOURce:AWGN Subsystem.....	495
7.15.2	SOURce:BB Subsystem.....	504
7.15.2.1	SOURce:BB Subsystem General Commands.....	504
7.15.2.2	SOURce:BB:ARB Subsystem.....	506
7.15.2.3	SOURce:BB:DM Subsystem.....	556
7.15.2.4	SOURce:BB:GRAPhics Subsystem.....	595
7.15.2.5	SOURce:BB:IMPairment Subsystem.....	598
7.15.2.6	SOURce:BB:MCCW Subsystem.....	600
7.15.2.7	SOURce:BB:MEASurement Subsystem.....	621
7.15.2.8	SOURce:BB:POWer Subsystem.....	625
7.15.2.9	SOURce:BB:PROGress Subsystem General Commands.....	626

7.15.3	SOURce:BBIN Subsystem.....	627
7.15.4	SOURce:INPut Subsystem.....	636
7.15.5	SOURce:IQ:OUTput Subsystem.....	638
7.15.5.1	SOURce:IQ:OUTPut Subsystem - I/Q Output.....	638
7.15.5.2	Analog I/Q Outputs.....	642
7.15.5.3	Digital I/Q Outputs.....	648
7.15.6	SOURce:PATH Subsystem.....	654
7.15.7	SOURce:ROSCillator Subsystem.....	654
<b>7.16</b>	<b>STATus Subsystem.....</b>	<b>656</b>
<b>7.17</b>	<b>SYSTem Subsystem.....</b>	<b>660</b>
<b>7.18</b>	<b>TEST Subsystem.....</b>	<b>669</b>
<b>7.19</b>	<b>UNIT Subsystem.....</b>	<b>672</b>
<b>8</b>	<b>Maintenance.....</b>	<b>673</b>
8.1	Storing and Packing.....	673
<b>9</b>	<b>Status Information, Error Messages and Troubleshooting.....</b>	<b>675</b>
<b>9.1</b>	<b>Status Information.....</b>	<b>675</b>
9.1.1	Status information displayed between PEP and level fields.....	675
9.1.2	Status information displayed to the left of the Info line.....	676
<b>9.2</b>	<b>Error Messages.....</b>	<b>677</b>
9.2.1	Volatile messages.....	677
9.2.2	Permanent messages.....	677
<b>9.3</b>	<b>SCPI-Error Messages.....</b>	<b>677</b>
<b>9.4</b>	<b>Device-Specific Error Messages.....</b>	<b>678</b>
<b>9.5</b>	<b>Resolving Network Connection Failures.....</b>	<b>680</b>
<b>9.6</b>	<b>Obtaining Technical Support.....</b>	<b>680</b>
	<b>Annex.....</b>	<b>683</b>
<b>A</b>	<b>Hardware Interfaces.....</b>	<b>683</b>
A.1	GPIB Bus Interface.....	683
A.2	AUX I/O Connector.....	684
A.3	Monitor Connector (MONITOR).....	686

<b>A.4 BERT Connector.....</b>	<b>686</b>
<b>List of Commands.....</b>	<b>689</b>
<b>Index.....</b>	<b>701</b>



# 1 Preface

## 1.1 Documentation Overview

The user documentation for the R&S AMU consists of the following parts:

- Quick start guide, printed manual
- Online help system on the instrument
- Operating manuals and online manual for base unit and options provided on the product page
- Service manual provided on the internet for registered users
- Instrument security procedures provided on the product page
- Release notes provided on the product page
- Data sheet and brochures provided on the product page
- Application notes provided on the Rohde & Schwarz website



You find the user documentation on the R&S AMU product page mainly at:

<http://www.rohde-schwarz.com/product/AMU200A.html> > "Downloads" > "Manuals"

Additional download paths are stated directly in the following abstracts of the documentation types.

---

### Quick Start Guide

Introduces the R&S AMU and describes how to set up and start working with the product. Includes basic operations, typical measurement examples, and general information, e.g. safety instructions, etc.

### Online Help

Offers quick, context-sensitive access to the information needed for operation and programming. It contains the description for the base unit and the software options.

### Operating Manuals and Online Manual

Separate manuals are provided for the base unit and the software options:

- **Base unit** manual  
Contains the description of the graphical user interface, an introduction to remote control, the description of all SCPI remote control commands, programming examples, and information on maintenance, instrument interfaces and error messages. Includes the contents of the **quick start guide** manual.
- **Software option** manuals  
Describe the specific functions of this option. Basic information on operating the R&S AMU is not included.

The **online manual** provides the contents of the operating manual for immediate display on the internet.

**Service Manual**

Describes the performance test for checking the rated specifications, module replacement and repair, firmware update, troubleshooting and fault elimination, and contains mechanical drawings and spare part lists.

The service manual is available for registered users on the global Rohde & Schwarz information system (GLORIS).

**Instrument Security Procedures**

Deals with security issues when working with the R&S AMU in secure areas.

**Data Sheet and Brochures**

The data sheet contains the technical specifications of the R&S AMU. Brochures provide an overview of the instrument and deal with the specific characteristics, see <http://www.rohde-schwarz.com/product/AMU200A.html> > "Download" > "Brochures and Data Sheets".

**Release Notes**

Describes the firmware installation, new and modified features and fixed issues according to the current firmware version. You find the latest version at:

<http://www.rohde-schwarz.com/product/AMU200A.html> > "Downloads" > "Firmware"

**Application Notes, Application Cards, White Papers, etc.**

These documents deal with special applications or background information on particular topics, see <http://www.rohde-schwarz.com/appnotes>.

## 1.2 Typographical Conventions

The following text markers are used throughout this documentation:

Convention	Description
"Graphical user interface elements"	All names of graphical user interface elements on the screen, such as dialog boxes, menus, options, buttons, and softkeys are enclosed by quotation marks.
KEYS	Key names are written in capital letters.
File names, commands, program code	File names, commands, coding samples and screen output are distinguished by their font.
<i>Input</i>	Input to be entered by the user is displayed in italics.
<a href="#">Links</a>	Links that you can click are displayed in blue font.
"References"	References to other parts of the documentation are enclosed by quotation marks.



## 1.3 Notes on Screenshots

When describing the functions of the product, we use sample screenshots. These screenshots are meant to illustrate as much as possible of the provided functions and possible interdependencies between parameters. The shown values may not represent realistic test situations.

The screenshots usually show a fully equipped product, that is: with all options installed. Thus, some functions shown in the screenshots may not be available in your particular product configuration.



## 2 Preparing for Use

The following topics will help you to get familiar with the instrument and perform the first steps:

- [Front Panel Tour](#)
- [Rear Panel Tour](#)
- [Putting into Operation](#)

This section explains the control elements and connectors of the Signal Generator R&S AMU with the aid of the front and rear views and describes how to put the instrument into operation. It also describes the connection of peripherals such as printer, keyboard or mouse. Specifications of interfaces can be found in the data sheet.

The [Chapter 3, "Getting Started"](#), on page 71 of this manual provides an overview of the generator functions and introduces the operating concept. Detailed operating instructions and an overview of menus follow in [Chapter 4, "Manual Operation"](#), on page 95.

For all reference information concerning manual and remote control of the instrument refer to the online help system or its printed/printable version. A more detailed description of the hardware connectors and interfaces is also part of the help system.

### 2.1 Front Panel Tour

The front panel of the R&S AMU consists of the VGA display with the softkey area, some utility keys (left side) and the hardkey area with connectors and control interfaces (right side). The subsequent sections provide brief explanations on the controls and connectors, the hardkey area and the front panel.

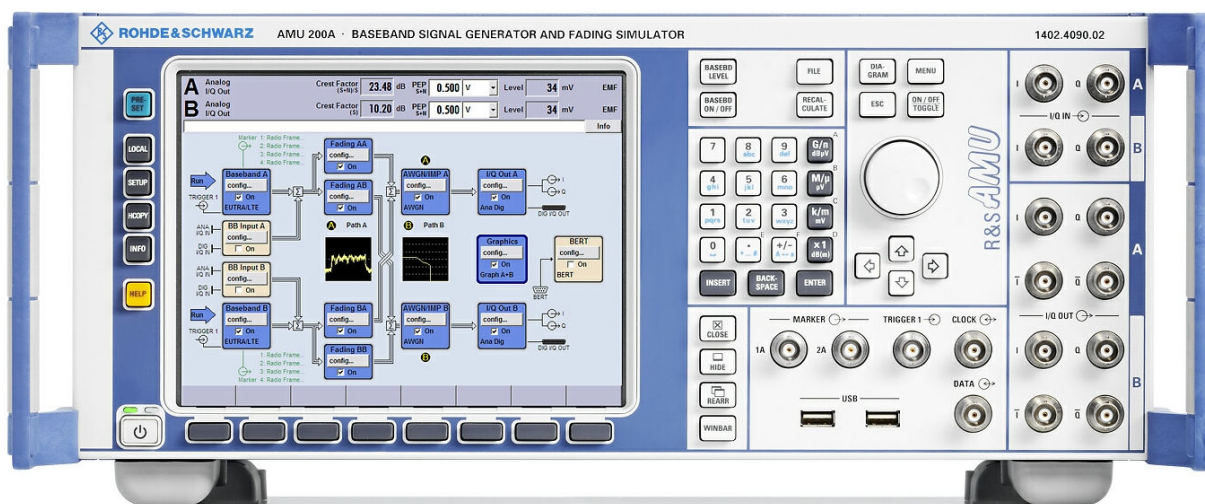

Figure 2-1: Front panel view

### 2.1.1 Utility Keys



The keys to the left of the display cause the R&S AMU to return to a definite instrument state and provide information on the instrument and assistance.

For more information refer to chapter "Instrument Settings".

#### PRESET

Sets the instrument to a defined state (see [Chapter 2.3.5.4, "Default Settings"](#), on page 38).

#### LOCAL

Switches from remote control to local (manual) control.

#### SETUP

Opens the "Setup" dialog for configuring presettings.

For more information, see [Chapter 5.2.3, "General Configuration of Instrument - Setup Key"](#), on page 137.

#### HCOPI

Opens the "Hardcopy" menu for configuring and starting printing.

For more information, see [Chapter 5.2.5, "Generating a Hard Copy of the Display"](#), on page 163.

#### INFO

Displays status messages, error messages and warnings.

#### HELP

Displays context-sensitive help text.

### 2.1.2 Standby LEDs and Standby Key

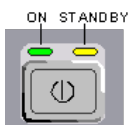

The standby LEDs and the ON/STANDBY key are located in the bottom left corner of the front panel.

The ON/STANDBY key toggles the instrument between standby and ready state (indicated by the standby LEDs).

The standby LEDs indicate the instrument states as follow:

- the green LED (left) is on when the instrument is ready for operation,
- the yellow LED (right) is on in the standby mode.

See also [Chapter 2.3.5.1, "Standby and Ready state"](#), on page 37.

### 2.1.3 Display

The display clearly shows all main settings and signal generator states.

The display is divided into the following sections:

- Level display with info line
  - Level and PEP settings containing auxiliary information such as insertion loss, crest factor and load type.  
In two-path instruments, level and PEP are displayed in two lines.
  - Status messages
  - Brief error messages; to access an window with detailed information for a message, use the INFO key.
- Block diagram

The block diagram shows the current configuration and the signal flow in the generator with the aid of function blocks containing an on/off switch. Selecting a function block opens a list of associated setting menus. Active menus, info windows and graphs are displayed on top of the block diagram. The block diagram can be displayed in the foreground anytime with the **DIAGRAM** key.
- "Winbar" with labelled softkeys

Open menus are indicated by a labelled button in the "Winbar". The buttons determine the softkey functions for front-panel control. When a button or softkey is pressed, the associated menu is displayed either in the foreground or minimized in the "Winbar".

If required, the WINBAR is covered by a row of buttons to which menu-specific functions of the active menu are assigned. By pressing the WINBAR key, the "Winbar" can be displayed in the foreground again. This allows the user to toggle between the button and softkey functions.

For detailed information, see [Chapter 4.2, "Display"](#), on page 100.

### 2.1.4 Setup Keys

The keys to the right of the display set parameters, select views and control the windows.

#### 2.1.4.1 Keys for Setting Parameters

These keys provide direct access to the settings in the header of the instrument and can be used for fast changing the state of the baseband signal.

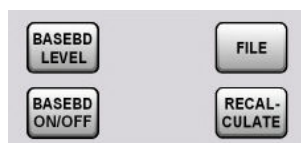

For more information refer to chapter "Instrument Functions".

#### **BASEBD LEVEL**

Activates the baseband level entry. In the two-path mode, the baseband level entry field that was active last is activated. Pressing the key again activates the baseband level entry for the second path.

#### **BASEBD ON/OFF**

Switches the Baseband signal on and off. In the two-path mode, the BASEBD ON/OFF key switches all signals off. A second stroke restores the status that was active before the last switch-off. "I/Q OUT OFF" is displayed in the status bar.

#### **FILE**

Activates the menu for storing or loading files (see [Chapter 4.7, "File Management"](#), on page 123).

#### **RECALCULATE**

Starts the recalculation of instrument settings.

If time-consuming calculations are required, the active modulation is automatically switched off and the calculation is interrupted to allow the user to make further settings. Calculation is restarted by a keystroke and the modulation is switched on again after the calculation is completed.

### 2.1.4.2 Display Keys



The keys on top of the rotary knob and the keys below the numeric key pad arrange different windows on the display.

#### **DIAGRAM**

Brings the block diagram to the foreground. Active menus are minimized.

Active menus are indicated by the buttons in the "Winbar".

#### **ESC**

The function of this key depends on the current cursor position.

- Calls the next higher selection level.
- Closes the open window without accepting new entries; the old value or parameter is retained.
- In dialog boxes that contain a "Cancel" button it activates that button.
- Closes all kinds of dialog boxes, if the edit mode is not active.
- Quits the edit mode, if the edit mode is active.
- Switches between different entry fields of a menu.
- Shifts the entry cursor from the header display to the previously active menu, or to the previously highlighted block in the block diagram if no menu is active.
- Shifts the cursor from a function block in the diagram to the first item in the "Winbar". If no menus are open, the current cursor position remains unchanged.

#### **TOGGLE**

- Switches highlighted elements or a function block on and off.

- Switches between two or more settings, e.g. items of selection lists. At the end of a list, the cursor is set on the first entry again.

**MENU**

Calls the menu tree.



**CLOSE**

Closes the active menu.

- If the entry mode is active, changes are cancelled.
- If settings in this menu require acknowledgment by means of an "Accept" button, a query is displayed asking whether the changes made should be cancelled.

**HIDE**

Minimizes the active open menu. The associated button in the "Winbar" remains visible.

**REARR**

Automatic rearrangement of open menus.

**WINBAR**

Toggles between display and blanking of the "Winbar".

**2.1.5 Keypad for data entry**

The keys in the data entry keypad are used to enter alphanumeric data and units.

Data entry keys are only enabled while the cursor is placed on a data input field in a dialog. Their function depends on the data type of the input field.



Keys	Description
0...9/abc	Enters the corresponding numbers (in numeric input fields) or characters (character input fields).
.	Inserts a decimal point (numeric input fields) or dot (character input fields) at the cursor position. Multiple decimal points are not allowed.
+/-	Changes the sign of a numeric parameter. In the case of an alphanumeric parameter, inserts a hyphen at the cursor position.

Keys	Description
Unit keys	Selects a unit and thus determine the absolute value, or changes the unit, i.e. trigger a recalculation without changing the absolute value. The function depends on the time at which the UNIT key is used during parameter entry (see <a href="#">Chapter 4.4.5, "Working with Units"</a> , on page 112). For unit-free values, the X1 key is equivalent to ENTER. It confirms the previous entry and deactivates the input field.
_	Adds a blank in a character input field.
*... #	Enters special characters. Toggles through the available characters if the key is pressed several times in a row.
A <-> a	Toggles between uppercase and lowercase characters.
A, B, C, D, E, F	Enters hexadecimal values. The letters assigned to the keys are automatically active when an entry field with a hexadecimal value is active.

**INSERT**

Toggles between insert and overwrite mode (see also [Chapter 4.4.4, "Entering a Value"](#), on page 110 ).

**BACKSPACE**

Deletes the last character before the cursor position or the selected character sequence.

**ENTER**

Pressing the rotary knob has the same effect.

- Concludes the entry of dimensionless entries. For other entries, this key can be used instead of the default unit key. The new value is accepted.
- Confirms ("OK") and closes open input windows.
- In a dialog box, selects the default or focused button.
- In a dialog box, activates the edit mode for the focused area, if available.
- In a dialog box, activates or deactivates the selected option of the focused area, if the edit mode is active.
- Calls the next menu level.

## 2.1.6 Rotary Knob and Navigation Keys

The rotary knob and the arrow keys are alternative control elements for data variation and navigation in the graphical user interface.

**ROTARY KNOB**

The rotary knob has several functions:

- Increases (clockwise direction) or decreases (counter-clockwise direction) numeric values at a defined step width in editing mode
- Moves the cursor, e.g. to a function block in the block diagram
- Scrolls within lists, tables or tree views
- Acts like the ENTER key, when it is pressed.
- Shifts the selection bar within focused areas (e.g. lists), if the edit mode is activated.



**Note:** Turning or pressing the rotary knob is equivalent to pressing the UP and DOWN keys or the ENTER key in the keypad.

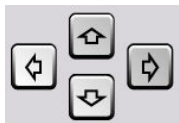

### NAVIGATION KEYS

The navigation keys consist of 4 arrow keys which are used for navigation, alternatively to the rotary knob.

**UP/ DOWN KEYS** The up and down arrow keys do the following:

- In a numeric edit dialog box, increase or decrease the instrument parameter.
- In a list, table, window or dialog box, scroll vertically.

**LEFT/ RIGHT KEYS** The left and right arrow keys do the following:

- In an alphanumeric edit dialog box, move the cursor forward and back.
- In a list, table, window or dialog box, scroll horizontally.

## 2.1.7 Front Panel Connectors

I/Q input and output connectors and various additional interface connectors are located on the front panel. Connectors that are assigned to one of the two paths are marked with the appropriate letter A or B. Not particularly marked interfaces affect both paths.

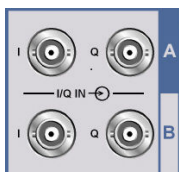

### I/Q IN

I and Q inputs for external analog baseband signal (option R&S AMU-B17, Baseband Input).

For more information see:

- [Chapter 5.7.2, "Data and Signal Sources in Baseband"](#), on page 242
- [Chapter 5.8.2.1, "Baseband Input Settings Menu"](#), on page 370

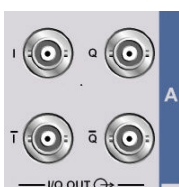

### I/Q OUT A/B

Direct output or differential (non-inverting) output of the analog I/Q signal (option R&S AMU-B16, Baseband differential).

For more information see:

- [Chapter 5.7.2, "Data and Signal Sources in Baseband"](#), on page 242
- [Chapter 5.8.2.1, "Baseband Input Settings Menu"](#), on page 370



### CLOCK

Signal for Path A only.

Input for external clock signal (bit or symbol clock, multiple of symbol clock) for synchronizing the external data signal in case of multivalent modulation. The active edge can be set.

Output for clock signal (bit or symbol clock) in the internal mode.



### DATA

Signal for Path A only.

Input for external serial data signal in case of digital modulation.

Output for serial data signal in case of digital modulation.

For more information see:

- [Chapter 5.7.2, "Data and Signal Sources in Baseband"](#), on page 242
- [Chapter 5.8.2.1, "Baseband Input Settings Menu"](#), on page 370



### TRIGGER 1

Input for triggering digital modulations, standards and ARB.

For more information see [chapter Chapter 5.2.3.9, "Global Trigger/Clock/External Input Settings"](#), on page 148.



### USB

USB (universal serial bus) interfaces of type A (host USB).

- Connection of peripherals such as mouse or keyboard
- Connection of memory stick for file transmission
- Firmware update

#### Note:

Further USB interfaces are provided on the rear panel:

- 2 type A interfaces (USB 1.1 and USB 2.0)
- 1 type B interface (device USB for data transmission)

See also [Chapter 2.4.1, "Connecting USB Devices"](#), on page 40.



### MARKER 1A, 2A

Outputs 1 and 2 for triggering and control of external devices with user-definable marker signals.

The instrument provides four outputs for marker signals. Marker signals 1 to 3 are permanently assigned to the outputs; marker signal 4 can be routed to one of the four USER outputs. The assignment is as follow:

#### Path A

- Marker 1,2: BNC connectors MARKER 1A/2A on the front panel, or on the rear panel.
- Marker 3: MARKER 3A pin of the AUX I/O connector on the rear panel.
- Marker 4: BNC connector USER 1 or USER 2/3/4 pins of AUX I/O connector on rear panel.

#### Path B

- Marker 1: MARKER 1B/2B output on the rear panel.
- Marker 3: MARKER 3B pin of the AUX I/O connector on rear panel.
- Marker 4: BNC connector USER 1 or USER 2/3/4 pins of AUX I/O connector on rear panel.

For more information see [Chapter 5.2.3.9, "Global Trigger/Clock/External Input Settings"](#), on page 148.

## 2.2 Rear Panel Tour

This section gives an overview of connectors on the rear panel of the instrument. Each connector is briefly described and a reference is given to the chapters containing detailed information. For technical data of the connectors refer to the data sheet.

If a connector of a two-path instrument is available for one path only (for example path A) or for either of the two (path A or B), a note is made in the brief description.



Figure 2-2: Rear panel view

## 2.2.1 Description of the Connectors



### LAN CONNECTOR

Ethernet interface

- For integrating signal generators in a network
- Remote control of signal generator
- Input of external asynchronous data
- Remote access to the signal generator
- Firmware update

See also:

- [Chapter 2.6, "Setting Up a Network \(LAN\) Connection"](#), on page 43
- [Chapter 6.1.3, "LAN Interface"](#), on page 383

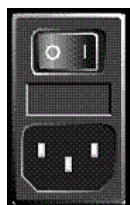

### AC SUPPLY AND POWER SWITCH

When the R&S AMU is connected to the AC supply, it automatically sets itself to the correct range for the applied voltage (range: see type label). There is no need to set the voltage manually or change fuses.

The power switch can be set to two positions:

- **0**  
The instrument is disconnected from the mains.
- **I**  
The instrument is power-supplied. It is either ready for operation (STANDBY) or in operating mode, depending on the position of the ON/STANDBY switch on the instrument front.

See also data sheet and [Chapter 2.3.4, "Connecting the Instrument to the AC Supply"](#), on page 36.



### I/Q IN A/B

Input for external analog modulation signal in case of I/Q modulation (independent for path A and B).

Input for external analog baseband signal (option R&S AMU-B17, Baseband Input).

Rear panel connectors for path A and path B (option R&S AMU-B81).

This option is recommended for use of the instrument in a 19" rack. Installing the instrument in a 19" rack requires a rack adapter or an adapter for telescopic sliders (refer to data sheet for order number).

For more information see [Chapter 5.7.2, "Data and Signal Sources in Baseband"](#), on page 242 and [Chapter 5.8, "External Baseband Signal - Baseband Input"](#), on page 367.

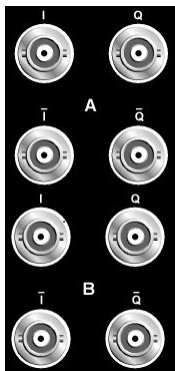

### I/Q OUT, I/Q BAR OUT

(path A or path B)

Direct output or differential (non-inverting) output for analog I/Q signal. For differential output option R&S AMU-B16 is required.

For the use of the instrument in a 19" rack, we recommend that you use the connectors for path A and B on the back (option R&S AMU-B81). Installing the instrument in a 19" rack additionally requires a rack adapter or an adapter for telescopic sliders (refer to data sheet for order number.).

See also [Chapter 5.5.3, "Analog I/Q Output Settings"](#), on page 212.



### INSTR TRIG

The INSTR TRIG connectors are reserved for future extensions.



### RESERVE

The RESERVE connector is reserved for future extensions.



### USER

Input/output for configurable signals for triggering and control.

The following signals can be applied to the connector:

- Marker 4
- Clock Out (bit or symbol)
- CW mode Out
- No signal (blank) marker

**Note:** With exception of the Clock Out signal, the signals for triggering and control apply for both paths.

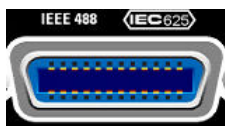
**IEC 625/IEEE 488**

IEC-bus (IEEE 488) interface for remote control of the instrument.

See also [Chapter A.1, "GPIB Bus Interface"](#), on page 683 and [Chapter 6.1.4, "GPIB Interface \(IEC/IEEE Bus Interface\)"](#), on page 386.

**Note:** In order to avoid electromagnetic interference (EMI) caused by open lines, always terminate any connected IEC-bus cable with an instrument or a controller.

**MARKER 1A/2A, 1B/2B**

Outputs 1 and 2 for triggering and control of external devices with user-definable marker signals.

The instrument provides four outputs for marker signals. Marker signals 1 to 3 are permanently assigned to the outputs; marker signal 4 can be routed to one of the four USER outputs (see ["MARKER 1A, 2A"](#) on page 26). The assignment is as follow:

**Path A**

- Marker 1,2: BNC connectors MARKER 1A/2A on the rear panel, or on the front panel.
- Marker 3: MARKER 3A pin of the AUX I/O connector on the rear panel.
- Marker 4: BNC connector USER 1 or USER 2/3/4 pins of AUX I/O connector on rear panel.

**Path B**

- Marker 1,2: MARKER 1B/2B output on the rear panel.
- Marker 3: MARKER 3B pin of the AUX I/O connector on rear panel.
- Marker 4: BNC connector USER 1 or USER 2/3/4 pins of AUX I/O connector on rear panel.

For the use of the instrument in a 19" rack, we recommend that you use the connectors for path A and B on the back (option R&S AMU-B81). Installing the instrument in a 19" rack additionally requires a rack adapter or an adapter for telescopic sliders (refer to data sheet for Order No.).

**Note:** MARKER 1A and 2A outputs are intended for future upgrades (option R&S AMU-B81).

For more information see [Chapter 5.2.3.9, "Global Trigger/Clock/External Input Settings"](#), on page 148.

See also [Chapter 2.3.3, "Placing or Mounting the Instrument"](#), on page 34.

**REF OUT**

Output of internal reference signal.

See also [Chapter 5.2.3.1, "Reference Oscillator"](#), on page 137.

**REF IN**

Input for external reference signal.

The external reference is used for both paths.

See also [Chapter 5.2.3.1, "Reference Oscillator"](#), on page 137.

**DATA IN/OUT**

Clock signal input/output.

Rear Panel Connectors for path A and path B (option R&S AMU-B81).

This option is recommended for use of the instrument in a 19" rack. Installing the instrument in a 19" rack requires a rack adapter or an adapter for telescopic sliders (refer to data sheet for order number).

See also [Chapter 5.7.2.4, "Clock Signals"](#), on page 245.

**DATA IN** Input for external serial data signal in case of digital modulation (path A). The active edge can be set (path A only).

**DATA OUT** Output for serial data in case of digital modulation (path A).

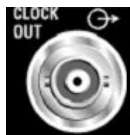
**CLOCK OUT**

Output for internal clock signal.

This connector is used for path A only. The internal clock signal of path B can be output at one of the USER interfaces.

See also [Chapter 5.7.2.4, "Clock Signals"](#), on page 245.

**CLOCK IN/OUT**

Clock signal input/output.

Rear Panel Connectors for path A and path B (option R&S AMU-B81).

This option is recommended for use of the instrument in a 19" rack. Installing the instrument in a 19" rack requires a rack adapter or an adapter for telescopic sliders (refer to data sheet for order number).

See also [Chapter 5.7.2.4, "Clock Signals"](#), on page 245.

**CLOCK IN** Input for external clock signal (bit or symbol clock, multiple of symbol clock) for synchronizing the external data signal in case of multivalent modulation. The active edge can be set (path A only).

**CLOCK OUT** Output for internal (bit or symbol) clock signal (path A). The internal clock signal of path B can be output at one of the USER interfaces.

**MONITOR**

Connector for external monitor (see [Chapter 2.4.2, "Connecting a Monitor"](#), on page 41).

For description of this connector, refer to [Chapter A.3, "Monitor Connector \(MONITOR\)"](#), on page 686.

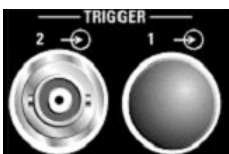
**TRIGGER 1 / 2**

**TRIGGER 2:** Input for external triggering of digital modulations and standards and ARB.

The trigger input is switchable to path A and/or to path B.

See also [Chapter 5.2.3.9, "Global Trigger/Clock/External Input Settings"](#), on page 148 and [Chapter 5.2.3.11, "User Marker / AUX I/O Settings"](#), on page 151.



**AUX I/O**

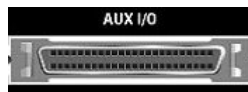

Parallel input/output for data signals as well as settable trigger and control signals of the baseband. Input for device trigger.

Assignment of the AUX I/O interface and of USER pins can be configured in the "Setup > Global Trigger/Clock/External Inputs" and "Setup > USER Marker / AUX I/O Settings".

Use this dialogs to configure also the arbitrary assignment of pins to path A or B.

**Note:** An adapter of the AUX I/O interface to coaxial BNC connectors is available as an accessory (R&S AMU-Z5, see data sheet).

See also [Chapter 5.2.3.9, "Global Trigger/Clock/External Input Settings"](#), on page 148 and [Chapter 5.2.3.11, "User Marker / AUX I/O Settings"](#), on page 151.

For detailed description of the AUX I/O connector, refer to [Chapter A.2, "AUX I/O Connector"](#), on page 684.



**BERT**

Input for data, clock and control signals for bit and block error rate measurements, level 0.0128..1.998V.



**USB IN**

USB (universal serial bus) interface of type B (device USB).

This interface is reserved for future extensions.

**Note:**

Further USB interfaces are provided:

- 2 type A interfaces (master USB ) on the front panel
- 2 type A interfaces (USB 1.1 and USB 2.0) on the rear



**USB CONNECTORS TYPE A**

USB (universal serial bus) interfaces of type A (host USB1.1 and USB 2.0).

- Connection of peripherals such as mouse, keyboard, etc.
- Connection of memory stick for file transmission
- Firmware update

Further USB interface type A are available on the front panel.

See also [Chapter 2.4.1, "Connecting USB Devices"](#), on page 40.

**BASEBAND DIGITAL IN/OUT**

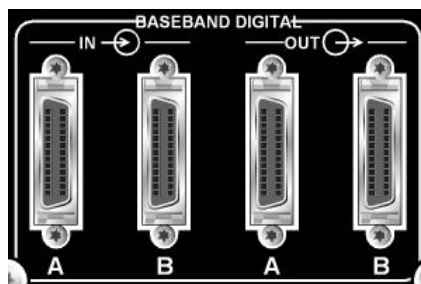

Digital Interface:

- Input for external digital I/Q signal (BBIN) in case of digital modulation (option R&S AMU-B17, Baseband Input (digital/analog)).
- Output of the digital I/Q signal (BBOUT) (option R&S AMU-B18 Digital I/Q Out).

**Note:** A further digital I/Q signal input requires a second option R&S AMU-B17, Baseband Input (digital/analog). Respectively, two-path instruments require a second option for digital I/Q output (option R&S AMU-B18, Digital I/Q Out).

Electromagnetic interference may disturb the digital data stream. Take precaution by complying with the EMC safety precautions recommended by Rohde&Schwarz (see "[Risk of electrostatic discharge \(ESD\)](#)" on page 33).

## 2.3 Putting into Operation

This section describes the basic steps to be taken when setting up the R&S AMU for the first time.

---

### **WARNING**

#### **Risk of injury and instrument damage**

The instrument must be used in an appropriate manner to prevent electric shock, fire, personal injury, or damage.

- Do not open the instrument casing.
- Read and observe the "Basic Safety Instructions" delivered as a printed brochure with the instrument.

In addition, read and observe the safety instructions in the following sections.

Notice that the data sheet may specify additional operating conditions.

---

### **NOTICE**

#### **Risk of instrument damage**

Note that the general safety instructions also contain information on operating conditions that will prevent damage to the instrument. The instrument's data sheet may contain additional operating conditions.

---



**NOTICE****Risk of instrument damage during operation**

An unsuitable operating site or test setup can cause damage to the instrument and to connected devices. Ensure the following operating conditions before you switch on the instrument:

- All fan openings are unobstructed and the airflow perforations are unimpeded. The minimum distance from the wall is 10 cm.
- The instrument is dry and shows no sign of condensation.
- The instrument is positioned as described in the following sections.
- The ambient temperature does not exceed the range specified in the data sheet.
- Signal levels at the input connectors are all within the specified ranges.
- Signal outputs are correctly connected and are not overloaded.

**NOTICE****Risk of electrostatic discharge (ESD)**

Electrostatic discharge (ESD) can cause damage to the electronic components of the instrument and the device under test (DUT). ESD is most likely to occur when you connect or disconnect a DUT or test fixture to the instrument's test ports. To prevent ESD, use a wrist strap and cord and connect yourself to the ground, or use a conductive floor mat and heel strap combination.

For details refer to the basic safety instructions included at the front of the manual.

### 2.3.1 EMI Suppression

Electromagnetic interference (EMI) may affect the measurement results.

To suppress generated Electromagnetic Interference (EMI),

- Use suitable shielded cables of high quality. For example use double-shielded RF and LAN cables.  
**Note:** USB cables are of varying and often poor quality. Therefore, check the quality of each individual USB cable as described in the service manual.
- Always terminate open cable ends.
- Use the cable R&S SMU-Z6 for connection to the DIG I/Q interfaces of the instrument. The required cable is available under part number 1415.0201.02.
- Note the EMC classification in the data sheet

### 2.3.2 Unpacking and Checking the Instrument

To remove the instrument from its packaging and check the equipment for completeness, proceed as follows:

1. Pull off the polyethylene protection pads from the instrument's rear feet and then carefully remove the pads from the instrument handles at the front.
2. Pull off the corrugated cardboard cover that protects the rear of the instrument.
3. Carefully unthread the corrugated cardboard cover at the front that protects the instrument handles and remove it.
4. Check the equipment for completeness using the delivery note and the accessory lists for the various items.
5. Check the instrument for any damage. If there is damage, immediately contact the carrier who delivered the instrument. Make sure not to discard the box and packing material.



#### **Packing material**

Retain the original packing material. If the instrument needs to be transported or shipped at a later date, you can use the material to protect the control elements and connectors.

---

### 2.3.3 Placing or Mounting the Instrument

The R&S AMU is designed for use under laboratory conditions, either on a bench top or in a rack using a rack adapter kit (order number see data sheet).

#### **Bench Top Operation**

If the R&S AMU is operated on a bench top, the surface should be flat. The instrument can be used in horizontal position, standing on its feet, or with the support feet on the bottom extended.

**⚠ CAUTION****Risk of injury if feet are folded out**

The feet may fold in if they are not folded out completely or if the instrument is shifted. This may cause damage or injury.

- Fold the feet completely in or completely out to ensure stability of the instrument. Never shift the instrument when the feet are folded out.
- When the feet are folded out, do not work under the instrument or place anything underneath.
- The feet can break if they are overloaded. The overall load on the folded-out feet must not exceed 500 N.

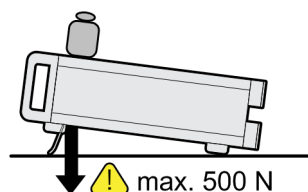
**⚠ CAUTION****Risk of injury and instrument damage if stacking instruments**

A stack of instruments may tilt over and cause injury. Furthermore, the instruments at the bottom of the stack may be damaged due to the load imposed by the instruments on top.

Observe the following instructions when stacking instruments:

- Never stack more than three instruments with the same dimensions (width and length). If you need to stack more than three instruments, install them in a rack.
- The overall load imposed on the lowest instrument must not exceed 500 N.
- All instruments should have the same dimensions (width and length). If you need to stack smaller instruments on the top, the overall load imposed on the lowest instrument must not exceed 250 N.
- If the instruments have foldable feet, fold them in completely.

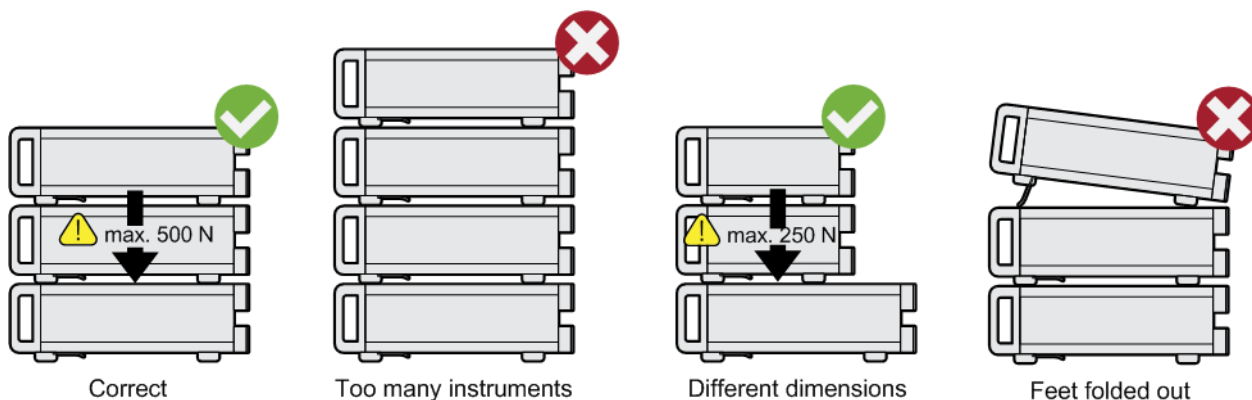

### Rackmounting

The R&S AMU can be installed in a rack using a rack adapter kit (Order No. see data sheet). The installation instructions are part of the adapter kit.

#### NOTICE

##### Risk of instrument damage in a rack

An insufficient airflow can cause the instrument to overheat, which may disturb the operation and even cause damage.

Make sure that all fan openings are unobstructed, that the airflow perforations are unimpeded, and that the minimum distance from the wall is 10 cm.

### 2.3.4 Connecting the Instrument to the AC Supply

The R&S AMU is automatically adapted to the AC voltage supplied. There is no need to set the voltage manually or change fuses. The [AC SUPPLY AND POWER SWITCH](#) is at the rear of the unit.

- ▶ Connect the instrument to the AC power source using the AC power cable delivered with the instrument.

**Note:** The instrument is in compliance with safety class EN61010-1. Connect the instrument only to a socket with earthing contact.

### 2.3.5 Starting the Instrument



#### Switching off the AC power

You can leave the AC power on permanently to preserve your last instrument settings. Switching off is required only if the instrument must be completely disconnected from all power supplies.

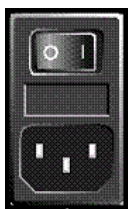

#### Starting up instruments with power switch

1. [Connect the instrument to the AC supply.](#)
2. To turn the power on, press the main power switch to position I (On).  
After power-up, the instrument is in [standby or ready state](#), depending on the state of the ON/STANDBY key at the front panel of the instrument when the instrument was switched off for the last time.
3. In case the instrument is in standby mode, i.e. the yellow LED is on, press the ON/STANDBY key to switch the instrument to ready state.

### 2.3.5.1 Standby and Ready state

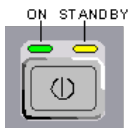

The ON/STANDBY key is located in the bottom left corner of the front panel.

#### Switching between standby and ready state

- ▶ Press the ON/STANDBY key briefly to switch the instrument from the standby to ready state or vice versa.

In ready state, the left, green LED is on. The instrument is ready for operation. All modules are power-supplied and the R&S AMU initiates its [startup procedure](#).

In standby state, the right, yellow LED is on. The standby power only supplies the power switch circuits and the oven-controlled crystal oscillator to keep it at its operating temperature. In this state it is safe to switch off the AC power and disconnect the instrument from the power supply.

### 2.3.5.2 Start Display and Booting

After power-on, the start display indicates for a few seconds the installed BIOS version and the processor characteristics.

The instrument boots the operating system, starts the instrument firmware and automatically performs a selftest. If the previous session was terminated regularly, the instrument uses the last setup with the relevant instrument settings.

Once the startup procedure has been terminated, the block diagram opened in the previous session is displayed and the instrument is ready for operation.



Use the PRESET key to return the instrument to its definite reset/preset state, if the current setup is not anymore relevant.

---

To customize the start settings, use the "File" dialog.

---



#### Rebooting the instrument

Press the STANDBY key for approx. 5 s. to reboot the instrument, if the software stops unexpectedly.

---

### 2.3.5.3 Function Check

The signal generator automatically monitors the main functions when the instrument is switched on and continuously during operation.

A detected fault is indicated by a "ERROR" message displayed in the info line together with a brief error description. For in-depth identification of the error, press the INFO key. In response, a description of the error(s) is displayed.

For more information, refer to [Chapter 9, "Status Information, Error Messages and Troubleshooting"](#), on page 675.

Additionally to the automatic monitoring, the R&S AMU offers the following capabilities to ensure correct functioning:

- **Internal Adjustments**  
Press the SETUP key and select "System > Internal Adjustments" to access the dialog for performing and configuring of the adjustments settings. A maximum level accuracy can be obtained, for instance.
- **Selftest**  
A selftest is provided for service purposes. The selftest is a protected test procedure, which can be accessed if protection level 1 is disabled.

#### 2.3.5.4 Default Settings

When the instrument is switched on, it is not the preset state that is active, but rather the instrument state that was set before the instrument was switched off. It is also recommended that you use the PRESET key to return the instrument to its defined preset state every time a new configuration is required or the current setup is not anymore relevant.

The R&S AMU offers a three-stage preset concept:

- **Preset of the settings belonging to a digital standard or associated with one dialog.**  
Most of the dialog boxes provide a special "Set to Default" button that resets directly the settings associated to the corresponding dialog, e.g. all digital modulation settings in the "Custom Digital Mod" dialog.  
These settings are identical to those which are called up using the PRESET key.
- **Preset the instrument to a predefined state**  
The PRESET key calls up a defined instrument setup. All parameters and switching states are preset (also those of inactive operating modes). The default instrument settings provide a reproducible initial basis for all other settings. However, functions that concern the integration of the instrument into a measurement setup are not changed, e.g. GPIB bus address or reference oscillator source settings. In remote control it is possible to preset the settings of the two instrument's paths separately (see section "Preset Commands").
- **Preset the instrument to its factory settings**  
The instrument can also be forced to load its default factory settings. To access the corresponding dialog box, press the SETUP key and select the "Factory Preset". For more information and an overview of the settings affected by the factory preset function, see [Chapter 5.2.3.17, "Factory Preset"](#), on page 161.

#### Overview of the Most Important Preset States

The following list gives an overview of the presets for the most important generator settings. The other presets can be found in the preset tables of the individual menus and the information accompanying the remote commands.

- "Reference frequency" = Internal; adjustment off
- "Offsets" = 0
- "Modulations State" = Off

Settings that are not affected by the PRESET key

- Reference frequency settings ("Ref Oscillator" menu)
- Power on settings ("Level/EMF" menu)
- Network settings ("Setup" menu)
- GPIB address ("Setup" menu)
- Password and settings protected by passwords ("Setup" menu)
- Start/Stop Display Update ("Setup" menu)
- Display and keyboard settings ("Setup" menu)



User-defined instrument states can be stored and called up in the "File" dialog.

### 2.3.6 Shutting Down the Instrument

To shut down the R&S AMU, proceed as described below.

#### **NOTICE**

##### **Risk of losing data**

If you switch off the running instrument using the rear panel switch or by disconnecting the power cord, the instrument loses its current settings. Furthermore, program data may be lost.

Press the ON/STANDBY key first to shut down the application properly.

1. Press the ON/STANDBY key to save the current setup, shut down the operating system and set the instrument to standby state.  
The yellow LED must be on.
2. To switch off the power, press the main power switch to position 0 (Off).  
None of the front-panel LEDs should be on.

## 2.4 Connecting External Accessories

The equivalent USB ports on the front and/or rear panel of the R&S AMU can be used to connect a variety of accessories.

In addition the instrument provides interfaces for monitor connection and network integration (see [Chapter 2.4.2, "Connecting a Monitor"](#), on page 41 and [Chapter 2.6.1, "Connecting the Instrument to the Network"](#), on page 44).

### 2.4.1 Connecting USB Devices

The USB interfaces of the R&S AMU allow you to connect USB devices directly to the instrument. This number can be increased as necessary by using USB hubs. Due to the large number of available USB devices, there is almost no limit to the expansions that are possible with the R&S AMU.

The following list shows various USB devices that can be useful:

- Memory stick for easy transfer of data to/from a computer (e.g. firmware updates)
- CD-ROM drives for easy installation of firmware applications
- Keyboard or mouse to simplify the entry of data, comments, file names, etc.
- Printer for printing out measurement results
- Power sensors, e.g. of the NRP Zxy family

Installing USB devices is easy under Windows, because all USB devices are plug&play. After a device is connected to the USB interface, the operating system automatically searches for a suitable device driver.

If Windows does not find a suitable driver, it will prompt you to specify a directory that contains the driver software. If the driver software is on a CD, connect a USB CD-ROM drive to the instrument before proceeding.

When a USB device is subsequently disconnected from the R&S AMU, Windows immediately detects the change in hardware configuration and deactivates the corresponding driver.

All USB devices can be connected to or disconnected from the instrument during operation.

#### Connecting a memory stick or CD-ROM drive

If installation of a memory stick or CD-ROM drive is successful, Windows informs you that the device is ready to use. The device is made available as a new drive and is displayed in Windows Explorer. The name of the drive depends on the manufacturer.

#### Connecting a keyboard

The keyboard is detected automatically when it is connected. The default input language is English – US.

Select "Start > Control Panel > Clock, Language, and Region > Change keyboards or other input methods" to configure the keyboard properties. To access the Windows operating system, press the Windows key on the external keyboard.

#### Connecting a mouse

The mouse is detected automatically when it is connected.

Select "Start > Control Panel > Devices and Printers > Mouse" to configure the mouse properties. To access the Windows operating system, press the Windows key on the external keyboard.



### Connecting a printer

When printing a file, the instrument checks whether a printer is connected and turned on and whether the appropriate printer driver is installed. If required, printer driver installation is initiated. A printer driver needs to be installed only once.

To install a printer, select "Start > Control Panel > Devices and Printers > Add a printer". To access the Windows operating system, press the Windows key on the external keyboard.

You can load updated and improved driver versions or new drivers from an installation disk, USB memory stick or another external storage medium. If the instrument is integrated in a network, you can also install driver data stored in a network directory.

Select "Start > Control Panel > Devices and Printers > Device Manager > Update Device drivers" to install the driver.

## 2.4.2 Connecting a Monitor

An external monitor with an analog interface can be connected to the MONITOR connector on the rear panel of the instrument. Per default, the external monitor connector is disabled and has to be enabled before operation.



### Connecting external devices

Before connecting any external device such as a monitor, make sure that the instrument is switched off (or in standby mode). Otherwise, correct operation cannot be assured. This does not apply to USB devices.

---

1. **Shut down the instrument.**

None of the front-panel LEDs should be on.

2. Plug in the monitor cable to the MONITOR connector on the rear panel of the instrument.

3. **Start up the instrument.**

The green LED must be on.

The external monitor is detected.

The entire display of the instrument, containing the status bar, the block diagram and the winbar is displayed on the monitor additionally. Further settings are not required.

The MONITOR interface is described in "Appendix A: Hardware Interfaces" in the Operating Manual.

## 2.5 Windows Operating System

The instrument contains the Windows Embedded Standard operating system which has been configured according to the instrument's features and needs. Changes in the system setup are only required when peripherals like keyboard or a printer are installed or if the network configuration does not comply with the default settings. After the R&S AMU is started, the operating system boots and the instrument firmware is started automatically.

To ensure that the instrument software functions properly, certain rules must be adhered to concerning the operating system.

---

### **NOTICE**

#### **Risk of causing instrument unusability**

The instrument is equipped with the Windows Embedded Standard operating system. Additional software can therefore be installed on the instrument. The use and installation of additional software may impair instrument function. Thus, run only programs that Rohde & Schwarz has tested for compatibility with the instrument software.

The drivers and programs used on the instrument under Windows Embedded Standard have been adapted to the instrument. Existing instrument software must always be modified using only update software released by Rohde & Schwarz.

---

The following program packages have been tested:

- R&S Power Viewer Plus - virtual power meter for displaying results of the Power Sensor R&S NRP-Zxx (install only this component!)
- Symantec Endpoint Security – Virus-protection software
- FileShredder - for reliable deletion of files on the hard disk

In certain cases, the use of these programs can impair the performance of the instrument.

### 2.5.1 Virus Protection

Users must take appropriate steps to protect their instruments from infection. Beside the use of strong firewall settings and regularly scanning any removable storage device used with a Rohde & Schwarz instrument, it is also recommended that anti-virus software be installed on the instrument. While Rohde & Schwarz does NOT recommend running anti-virus software in the background ("on-access" mode) on Windows-based instruments, due to potentially degrading instrument performance, it does recommend running it during non-critical hours.

For details and recommendations, see the Rohde & Schwarz White Paper [1DC01: Malware Protection](#).

## 2.5.2 Service Packs and Updates

Microsoft regularly creates security updates and other patches to protect Windows-based operating systems. These are released through the Microsoft Update website and associated update server. Instruments using Windows, especially those that connect to a network, should be updated regularly.

For details and recommendations, see the Rohde & Schwarz White Paper [1DC01: Malware Protection](#).

## 2.5.3 Login

Windows Embedded Standard requires that users identify themselves by entering a user name and password in a login window. The instrument provides a factory-installed auto login function, i.e. login is carried out automatically in the background. The ID used for autologin has administrator rights so that printer and network installations are possible. The user name and password are set to "instrument".

## 2.5.4 Accessing the Start Menu

All necessary system settings can be defined in the "Start > Control Panel" menu (for required settings refer to the Windows Embedded Standard documentation and to the hardware description).

### Energy saving mode

An energy saving mode is a default setting in the instrument. The hard disk switches to power-save mode if it is not accessed for 30 minutes. The energy-saving mode is exited by accessing the hard disk again.

## 2.6 Setting Up a Network (LAN) Connection

The R&S AMU is equipped with a network interface and can be connected to an Ethernet LAN (local area network). Provided the appropriate rights have been assigned by the network administrator and the Windows firewall configuration is adapted accordingly, the interface can be used, for example:

- To transfer data between a controlling device and the test device, e.g. in order to run a remote control program.  
See chapter "Remote Control"
- To access or control the measurement from a remote computer using the "Remote Desktop" application (or a similar tool)
- To connect external network devices (e.g. printers)
- To transfer data from a remote computer and back, e.g. using network folders

This section describes how to configure the LAN interface. It includes the following topics:

- [Chapter 2.6.1, "Connecting the Instrument to the Network"](#), on page 44
- [Chapter 2.6.2, "Assigning the IP Address"](#), on page 45

**LXI**

The R&S AMU complies with LXI Class C. LXI gives you direct access to the LAN settings described below.

**Accessing Operating System**

The operating system can only be accessed if an external keyboard and/or a mouse is connected. Windows provides an on-screen keyboard that can be operated using a mouse, thus enabling operation by mouse only. An external keyboard is recommended for extensive entries.

## 2.6.1 Connecting the Instrument to the Network

There are two methods to establish a LAN connection to the instrument:

- A non-dedicated network (Ethernet) connection from the instrument to an existing network made with an ordinary RJ-45 network cable. The instrument is assigned an IP address and can coexist with a computer and with other hosts on the same network.
- A dedicated network connection (Point-to-point connection) between the instrument and a single computer made with a (crossover) RJ-45 network cable. The computer must be equipped with a network adapter and is directly connected to the instrument. The use of hubs, switches, or gateways is not required, however, data transfer is still performed using the TCP/IP protocol. An IP address has to be assigned to the instrument and the computer, see [Chapter 2.6.2, "Assigning the IP Address"](#), on page 45.

The R&S AMU uses the IP addresses 192.168.xxx.yyy for this purposes, where xxx and yyy may take values between 1...254; the subnet mask is always 255.255.255.0.

**NOTICE****Risk of network failure**

Before connecting the instrument to the network or configuring the network, consult your network administrator. Errors may affect the entire network.

- ▶ To establish a non-dedicated network connection, connect a commercial RJ-45 cable to one of the LAN ports.  
To establish a dedicated connection, connect a (crossover) RJ-45 cable between the instrument and a single PC.

If the instrument is connected to the LAN, Windows automatically detects the network connection and activates the required drivers.

The network card can be operated with a 10 Mbps Ethernet IEEE 802.3 or a 100 Mbps Ethernet IEEE 802.3u interface.

## 2.6.2 Assigning the IP Address

Depending on the network capacities, the TCP/IP address information for the instrument can be obtained in different ways.

- If the network supports dynamic TCP/IP configuration using the Dynamic Host Configuration Protocol (DHCP), all address information can be assigned automatically.
- If the network does not support DHCP, or if the instrument is set to use alternate TCP/IP configuration, the addresses must be set manually.

By default, the instrument is configured to use dynamic TCP/IP configuration and obtain all address information automatically. This means that it is safe to establish a physical connection to the LAN without any previous instrument configuration.

---

### **NOTICE**

#### **Risk of network errors**

Connection errors can affect the entire network. If your network does not support DHCP, or if you choose to disable dynamic TCP/IP configuration, you must assign valid address information before connecting the instrument to the LAN. Contact your network administrator to obtain a valid IP address.

---

#### **Assigning the IP address manually**

1. Obtain the IP address and subnet mask for the R&S AMU and the IP address for the local default gateway from your network administrator. If necessary, also obtain the name of your DNS domain and the IP addresses of the DNS and WINS servers on your network. If you use more than one LAN connector, you need separate address information for each connector.
2. Press the "Windows" key to access the operating system.
3. Open the "Control Panel" by selecting "Start > Settings > Control Panel".
4. Select "Network Connections".
5. Right-click "Local Area Connection" and select "Properties" from the context-sensitive menu, or click "Local Area Connection" and then "File > Properties".
6. On the "General" tab, click "Internet Protocol (TCP/IP)" and then select "Properties".
7. Select "Use the following IP address" and enter the address information as obtained from the network administrator.

8. If necessary, you can also select "Use the following DNS server addresses" and enter your own DNS addresses.

For more information refer to the Windows Help.

### 2.6.3 Using computer names

In a LAN that uses a DNS server (Domain Name System server), each PC or instrument connected in the LAN can be accessed via an unambiguous computer name instead of the IP address. The DNS server translates the host name to the IP address. This is especially useful when a DHCP server is used, as a new IP address may be assigned each time the instrument is restarted.

Each instrument is delivered with an assigned computer name, but this name can be changed.

The default instrument name is a non-case-sensitive string that follows the syntax `rs<instrument><serial number>`.

The serial number can be found on the rear panel of the instrument. It is the third part of the device ID printed on the bar code sticker:



#### Querying and changing a computer name

1. Press the "Windows" key to access the operating system.
2. Select "Start > My Computer > Properties > Computer Name".  
The computer name is displayed under "Full Computer Name".
3. To change the computer name, select "Change", enter the new computer name and confirm the entry.

### 2.6.4 Changing the Windows Firewall Settings

A firewall protects an instrument by preventing unauthorized users from gaining access to it through a network. Rohde & Schwarz highly recommends the use of the firewall on your instrument. Rohde & Schwarz instruments are shipped with the Windows firewall enabled and preconfigured in such a way that all ports and connections for remote control are enabled.

For more details on firewall configuration, see the Rohde & Schwarz White Paper [1DC01: Malware Protection](#).

Note that changing firewall settings requires administrator rights.



To transfer waveform files generated on an external PC using R&S WinIQSIM2, you have to disable the firewall.

### NOTICE

#### Risk of Unauthorized Access

Disabling the firewall or allowing exceptions may make your instrument more vulnerable to viruses and intruders.

It is recommended that you restore the default firewall configuration after completing a task which requires modified settings.

## 2.6.5 Working with Directories

Access to network drives depends on access rights and whether the drives in question have been enabled. The complete integration of the R&S AMU into a larger network with the necessary allocation of rights is highly complex and normally performed by a network administrator.

However, the hard disk of a computer also connected to the network can be accessed from the instrument relatively easily. The only precondition is that the directory on the remote computer that the instrument should access is enabled for remote access. Subsequently, this directory is accessed from the instrument using a Windows Embedded Standard search function. This procedure is also of importance for a point-to-point connection, for instance in order to start a firmware update for which the files have been stored on the hard disk of the remote computer.



The computer and the instrument must both be provided with a computer name and an IP address (see [Chapter 2.6.2, "Assigning the IP Address"](#), on page 45).

### Enabling directories on the remote computer



The menu name may deviate from the name specified in the operating sequence, depending on the language and on the operating system used on the computer.

1. On the remote computer, in Windows Explorer, click the directory to be enabled.
2. From the context menu, select "Properties".
3. Select the "Sharing" tab and enable "Share this folder".

### Accessing the enabled directory

1. On the instrument, select "Start > Search > For Files and Folders > Printers, Computers > A Computer in the Network".
2. Enter the computer name and press ENTER to start the search.

The computer and its name appears in the results list.

3. Click the computer's name to display the enabled directory.

**Note:** If a user name and password are requested when you click the computer, the login name and password used on the computer must be entered.

The files in this directory can be accessed by the instrument.

## 2.7 Remote Access via an External Controller

The R&S AMU can be remote accessed from a remote computer (external controller) via a network link. This allows convenient operation of the instrument from the desktop although the instrument is integrated in a rack somewhere else.



For an overview of the instrument's operating concept and the different ways to control and operate the instrument, see [Chapter 3.1, "Brief Introduction to the Instrument's Concept"](#), on page 71.

There are different ways to establish a remote access connection to the signal generator but all of them require an established LAN connection between the instrument and the remote computer. The simplest way to remote access the instrument is to use a Web browser, such as Windows Internet Explorer or Mozilla Firefox for instance. Alternatively a remote access via a special application can be used.

For example, the free-of-charge programs "Remote Desktop" for PCs with windows operating system, or "Ultr@VNC" for PCs with Linux/Unix or Windows operating system are available for setting up the remote access connection. Using these applications requires additional installation.

See the following table for an overview of the different ways to establish a remote access connection to the signal generator.

**Table 2-1: Remote access via an external computer**

Remote access via	LAN connection	Installation of the additional application	
		on the instrument	on the remote computer
Web Browser for example Windows Internet Explorer or Mozilla Firefox see <a href="#">Chapter 2.7.1, "Using a Web Browser for Remote Access"</a> , on page 49	required	no	no
Web browser with HTML5 for example LXI Browser, see <a href="#">Chapter 2.9.2.4, "Web Control"</a> , on page 67	required	no	Web sockets must be supported.



Remote access via	LAN connection	Installation of the additional application	
		on the instrument	on the remote computer
Remote Desktop Windows application for PCs with Window operating system see <a href="#">Chapter 2.7.2, "Remote Desktop Connection"</a> , on page 50	required	no	required
VNC Client for example Ultr@VNC or other dedicated client software for PCs with Linux/Unix or Windows operating system see <a href="#">Chapter 2.7.3, "Remote Access via a VNC Client Software"</a> , on page 53	required	required	VNC Viewer required

When the connection is set up with Remote Desktop, the device firmware of the signal generator is disabled. Direct control on the instrument is not possible while manual remote-control is active. The access of an external PC is indicated by the logon screen of the operating system which identifies the accessing user.

When the connection is set up with a VNC client software (Ultr@VNC), direct control on the instrument is possible while remote access is established.

For return to direct operation on the instrument, the connection must be cut. After cutting the connection, it is still enabled and can be established again any time. The connection is disabled only after deactivation of the program.

This section gives an information on how to use the Web browser for remote access, how to install the applications for remote access and how to establish the connection between the instrument and an external computer with Windows operating system. Remote access via an external computer with Linux/Unix operating system is performed accordingly.



### Accessing Operating System

The operating system can only be accessed if an external keyboard and/or a mouse is connected. Windows provides an on-screen keyboard that can be operated using a mouse, thus enabling operation by mouse only. An external keyboard is recommended for extensive entries.



### Default password

Remote-access and file access require the user "instrument" with default password "instrument".

## 2.7.1 Using a Web Browser for Remote Access

The instrument can be remote-accessed via any web browser, as for example the Windows Internet Explorer or Mozilla Firefox.



Alternatively, you can also make use of the LXI browser, as described in [Chapter 2.9.2.4, "Web Control"](#), on page 67.

To remote access the instrument via a web browser:

1. Connect the instrument and the remote computer to a LAN, see [Chapter 2.6.1, "Connecting the Instrument to the Network"](#), on page 44.
2. Instal the Java Runtime Environment JRE on the remote computer.
3. Type the instruments' IP address in the address field of the Web browser on your PC, e.g. `http://10.111.11.1`

The "VNC Authentication" screen appears.

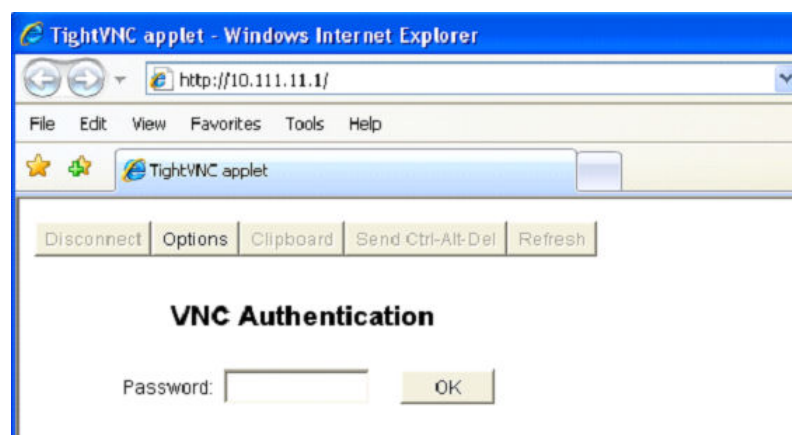

4. Enter the password and select "OK".  
The default password is "instrument".

After the connection is established, the current signal generator screen with the block diagram is displayed and the instrument can be remote-accessed from the remote computer.

## 2.7.2 Remote Desktop Connection

Remote Desktop is a Windows application which can be used to access and control the instrument from a remote computer through a LAN connection. While the instrument is in operation, the instrument screen contents are displayed on the remote computer, and Remote Desktop provides access to all of the applications, files, and network resources of the instrument. Thus, remote operation of the instrument is possible.

**NOTICE****Risk of Unauthorized Access**

If the Windows Remote Desktop application is enabled on the instrument (go to "Start > Settings > Control Panel > System"), any user in the network who knows the computer name and login data can access it. To prevent this, make sure that the Remote Desktop application on the instrument is disabled.

**To set up a Remote Desktop connection**

1. Enable remote desktop control on the instrument.
2. Connect the instrument and the remote computer to a LAN, see [Chapter 2.6.1, "Connecting the Instrument to the Network"](#), on page 44.
3. Set up the Remote Desktop connection between the remote computer and the instrument.

**Remote Desktop Client**

With Windows Embedded Standard, Remote Desktop Client is part of the operating system and can be accessed via "Start > Programs > Accessories > [Communications >] Remote Desktop Connection."

For other versions of Windows, Microsoft offers the Remote Desktop Client as an add-on.

**Enabling remote desktop control on the instrument**

1. Press the "Windows" key to access the operating system.
2. Open the Control Panel by selecting "Start > Settings > Control Panel".
3. Select "System" and switch to the "Remote" tab.
4. Under "Remote Desktop", activate the "Allow users to connect remotely to this computer" option.

**Note:** Remote Desktop access and firewall settings.

When you enable or disable the Windows Remote Desktop option (in the "System Properties"), the associated firewall settings are adapted automatically.

5. If necessary, click "Select Remote Users" and select users who are to be given access to the R&S AMU via Remote Desktop. The user account under which configuration is carried out is automatically enabled for Remote Desktop.

**Setting up the Remote Desktop connection on the remote computer**

1. On the remote computer, select "Start > Programs > Accessories > [Communications >] Remote Desktop Connection."
2. Enter the instrument's name or IP address in the dialog box (see also [Chapter 2.6.2, "Assigning the IP Address"](#), on page 45).

3. Enter the user ID and password for the instrument (see also [Chapter 2.5, "Windows Operating System"](#), on page 42).
4. Click "Connect".

When the connection has been set up, the instrument's screen appears on the remote computer.



#### Disabled Direct Control

While remote access is active, the direct control of the instrument is disabled.

Remote access is indicated on the instrument by the logon screen of the operating system. The logon screen identifies the accessing user.

---

For simultaneous remote access of several instruments from the same PC, a separate Remote Desktop session must be opened for each instrument.

For detailed information about Remote Desktop and the connection refer to the Windows Help.

#### Helpful settings for Remote Desktop

The following settings for the Remote Desktop connection can make working on the remote PC more convenient.

1. When setting up the connection to the instrument, you can configure the connection settings in the "Remote Desktop Connection" dialog box. Click the "Options >>" button.  
The dialog box is expanded to display the configuration data.
2. Customize the settings:
  - **On the "Experience" tab:**
    - Select the appropriate connection to optimize the connection speed.
    - To improve the performance, you can deactivate options you do not require under "Allow the following".
  - **On the "Local Resources" tab:**
    - If you need to access drives of the remote PC from the instrument (e.g. in order to store settings or to copy files from the PC to the instrument), activate the "Disk drives" option. Windows Embedded Standard will then map drives of the remote PC to the corresponding network drives. When a connection is established, a warning is displayed on the PC indicating that the drives are enabled for access from the instrument.
    - To use printers connected to the remote PC while accessing them from the instrument, activate the "Printers" options. Do not change the remaining settings.
  - **On the "Display" tab:**
    - Under "Remote desktop size", set the size of the R&S AMU window on the desktop of the remote PC.
    - Activate the "Display the connection bar when in full screen mode" option.

A bar showing the network address of the instrument is displayed on the screen which you can use to reduce, minimize or close the window.

- **On the "General" tab:**

You can save the connection settings for later use using the "Save As" button.

### Terminating Remote Desktop Control

A Remote Desktop connection can be terminated either on the R&S AMU or on the remote PC. The connection can be established again any time as long as remote control is enabled on the instrument. Consider the notice above concerning unauthorized access due to Remote Desktop!

1. To terminate the connection on the instrument, click "Disconnect" in the remote-control message menu of the R&S AMU.
2. To terminate the connection on the remote PC, close the "Remote Desktop" window, or select "Start > Disconnect".

### Disabling Remote Desktop Control

To disable the remote access, deactivate the Remote Desktop on the instrument.

- ▶ Under "Remote Desktop", disable the "Allow users to connect remotely to this computer" option and confirm with "OK".

The connection is disabled, it is no longer possible to access the instrument via Remote Desktop.

## 2.7.3 Remote Access via a VNC Client Software

A VNC client software is an application which can be used to access and control the instrument from a remote computer via LAN.

The following description explains how to establish the remote access, represented by means of the client software Ultr@VNC. The software is included in Linux/Unix operating system, but it is also available as a free-of-charge download on the Internet <http://www.uvnc.com/download/index.html>. Thus, it is also available for remote computers with Windows operating system.



The GUI appearance of Ultr@VNC may vary if you use a later release. Also, similar programs may deviate in some details, but the basic procedure is the same.

---

### **NOTICE**

#### **Risk of Unauthorized Access**

If the VNC service is enabled on the instrument, any user in the network who knows the computer name and password can access it.

Disable the VNC service on the instrument to prevent unauthorized access.

---

### Setting up a VNC connection

1. Connect the instrument and the remote computer to a LAN, see [Chapter 2.6.1, "Connecting the Instrument to the Network"](#), on page 44.
2. [Install the Ultr@VNC application](#) and enable it on the instrument.
3. In the ICF firewall, enable communication on the network via Ultr@VNC program. See ["Configuring Internet Connection Firewall for VNC Connection"](#) on page 56.
4. Install the VNC Viewer on the remote computer with Windows operating system, see ["Installing the VNC Viewer on a Windows PC"](#) on page 57.
5. Set up the VNC connection between the instrument and:
  - a) the remote computer with Linux/Unix operating system, see ["Setting up the VNC connection on the Linux/Unix remote computer"](#) on page 57;
  - b) the remote computer with Windows operating system, see ["Setting up the VNC connection on the Windows remote computer"](#) on page 58.



### Enabled Direct Control

The direct control of the instrument is not disabled and the instrument can be controlled from the front panel and via the remote computer alternately.

### Installing the Ultr@VNC application

1. Download the program from the internet and copy it to a directory that can be accessed.
2. On the instrument, shut down firmware using the ALT+F4 key combination.
3. Double click on the setup file to start the installation.  
The setup wizard leads through the installation. This description focus only on the relevant settings.
  - a) Select installation of all components.

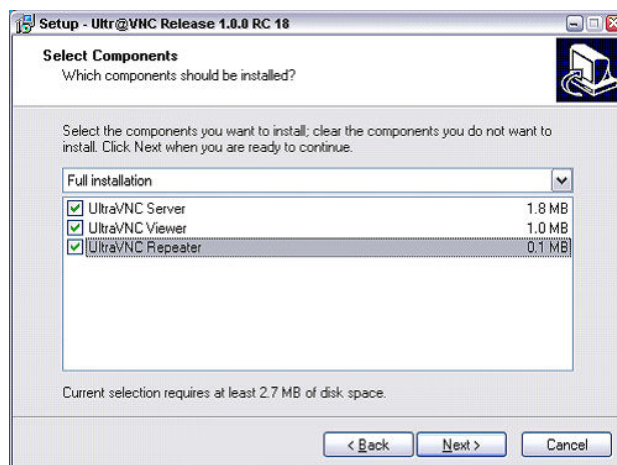

b) In the "Additional Task Panel", enable all entries.

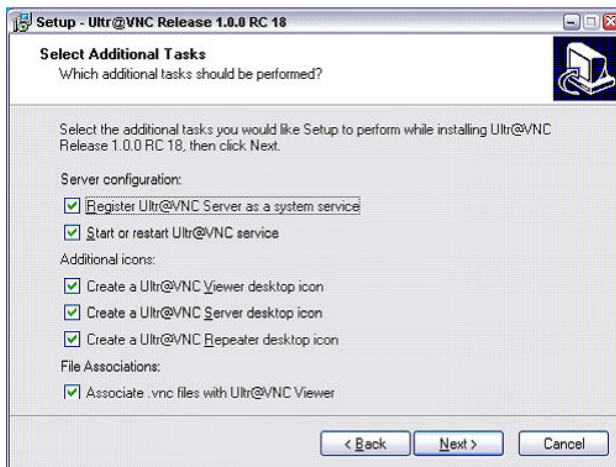

A successful installation is indicated by a message.

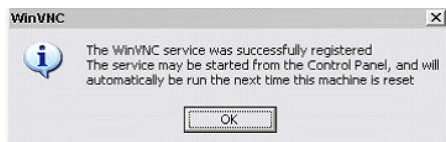

At the same time a warning is displayed stating that a password must be set.

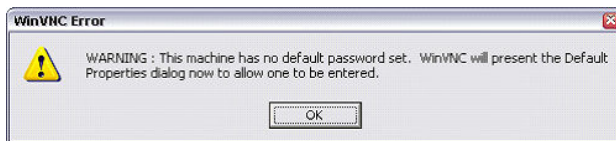

4. Select "OK".

The "Default Local System Properties" panel opens.

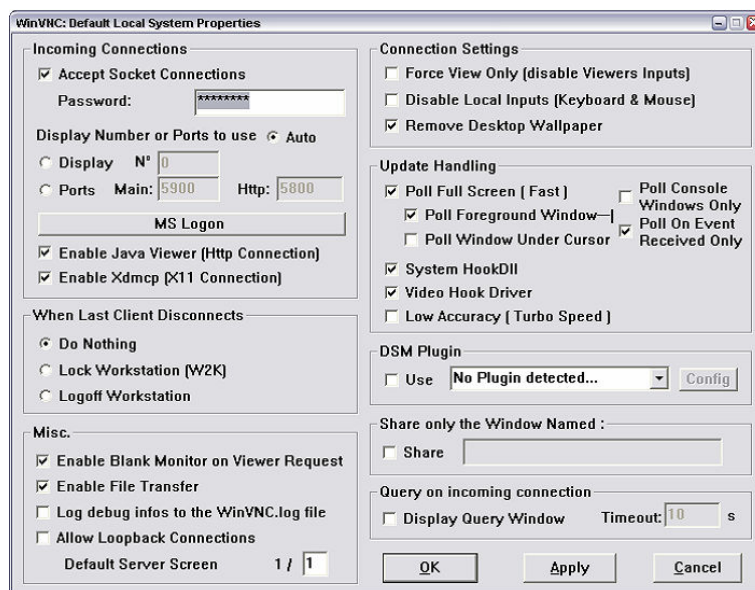



5. Enter a password with a length of at least five digits.  
This password is used on the remote computer to access the instrument. Other settings may be changed according to the user-specific security requirements.

After the installation the Ultr@VNC program is automatically started together with the operating system. On mouse over, the IP address of the instrument is indicated.

This IP address and the user-defined password are the prerequisites to enable remote access on the remote computer. Terminated connection is indicated by changed icon color.

### Configuring Internet Connection Firewall for VNC Connection

To enable remote access of an instrument in a local network via VNC connection, the connection must be specifically permitted in the firewall.

1. Press the "Windows" key to access the operating system and select "Start > Settings > Control Panel > Windows Firewall" to open the "Windows Firewall".
2. Select "Exceptions > Add Program... > Run Ultr@VNC SERVER" and confirm with "OK".

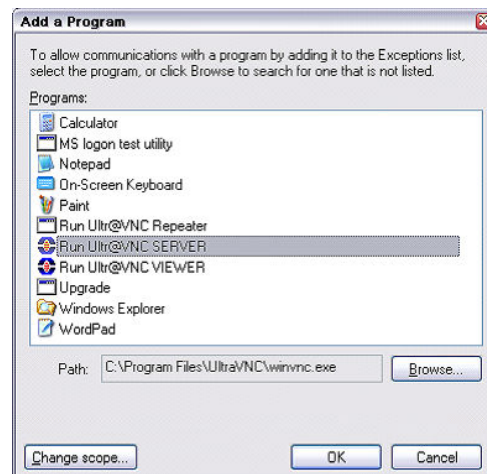

3. In the "Exceptions" tab, enable "Run Ultr@VNC SERVER".



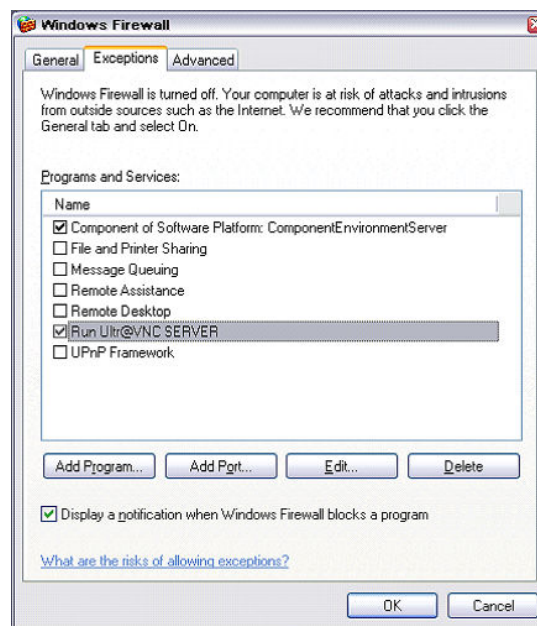

### Installing the VNC Viewer on a Windows PC

1. Download the Ultr@VNC program from internet and follow the installation instructions.

Only the program component VNC Viewer is required.

**Note:** The VNC Viewer program is included in the download for the installation of the Ultr@VNC program on the signal generator if "Full installation" was selected in the "Select Component" panel. In this case, the program `ultr@vncviewer.exe` can be copied to the Windows PC.

2. Install VNC Viewer program component on the remote computer.

### Setting up the VNC connection on the Linux/Unix remote computer

The VNC program is available per default for Linux/Unix operating systems.

1. Start a Web browser on the remote computer and enter the IP address of the instrument.

2. Enter the following address:

`vnc://<IP-address of the instrument>`, e.g. `vnc://192.168.1.1`.

A dialog is opened and the password for the remote VNC connection is requested.

3. Enter the password as defined in the "Default Local System Properties" panel of the Ultr@VNC program and select "Log On".

The connection is established, the instrument is remote accessed and the current signal generator screen with the block diagram is displayed. The individual functions are operated using the mouse and keyboard.

In contrast to remote access via Remote Desktop, the direct control of the instrument is not disabled and the instrument can be controlled from the front panel and via the remote computer alternately.

### Setting up the VNC connection on the Windows remote computer

1. Start VNC Viewer program component on the PC, select "VNC Server" and enter IP address of the instrument.

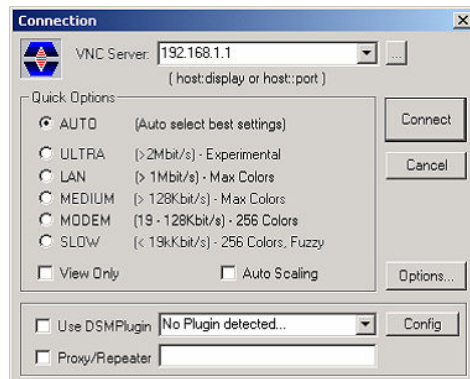

2. To initialize the connection, select "Connect".  
A message requesting the password appears.

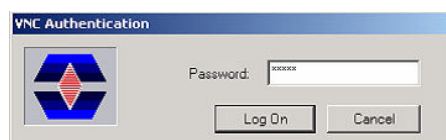

3. Enter the password as defined in the "Default Local System Properties" panel of the Ultr@VNC program and select "Log On".

The connection is established, the instrument is remote accessed and the current signal generator screen with the block diagram is displayed. The individual functions are operated using the mouse and keyboard.



#### Enabled Direct Control

The direct control of the instrument is not disabled and the instrument can be controlled from the front panel and via the remote computer alternately.

#### Terminating VNC Connection

The remote access via VNC connection can be terminated either on the R&S AMU or on the external PC. Terminating the connection does not disable it. It can be established again any time. See the notice above concerning unauthorized access due to VNC connection!

1. Terminate the connection on the R&S AMU
  - a) Press the "Windows" key to access the operating system.
  - b) Right-click on the VNC icon on the task bar and select "Kill all clients".
2. To terminate the connection on the external Linux/Unix PC, close the internet browser or close the signal generator window.

3. To terminate the connection on the external Windows PC, close the VNC Viewer program.

The connection is terminated. The color of the VNC icon in the status bar of the instrument changes.

A message on the external PC indicates the disconnection.

#### **Disabling Remote Access via Ultr@VNC**

The VNC connection can be disabled by removing the program on the instrument or by deactivating the VNC Server service.

1. Remove the VNC program
  - a) Press the "Windows" key to access the operating system and open the "Add or Remove Programs" by selecting "Start > Settings > Control Panel > Add or Remove Programs".
  - b) Remove the VNC program.
2. Deactivate the VNC Server service
  - a) Press the "Windows" key to access the operating system and open the "Services" by selecting "Start > Settings > Control Panel > Services".
  - b) Deactivate the VNC Server service.

The connection is disabled, the VNC icon disappears from the task bar of the instrument.

## **2.8 Using Virus-Protection Software**

Virus-protection software Symantec Antivirus 10.1.7.7000 has been successfully tested for compatibility with the instrument software on R&S AMU.

However, Symantec Antivirus may affect the behavior of the instrument in terms of settling time or stability. Symantec Antivirus 10.1.7.7000 has been subjected to detailed tests with R&S AMU and a page file of 1024 MB. The system remains very reliable. However, rare impact on the settling time has been experienced ( slight degradations of settling time in 2% of samples out of specification).

#### **Preparing the Installation of Symantec Antivirus**

The installation is performed in the operating system.



#### **Accessing Operating System**

The operating system can only be accessed if an external keyboard and/or a mouse is connected. Windows provides an on-screen keyboard that can be operated using a mouse, thus enabling operation by mouse only. An external keyboard is recommended for extensive entries.

1. Press the "Windows" key to access the operating system and open the "System" dialog by selecting "Start > Settings > Control Panel > System".

2. In the "System" dialog, select the "Advanced > Performance > Settings > Change".
3. Enable "Drive D: [DATA]" and "System managed size", confirm with "Set" and close the dialog.

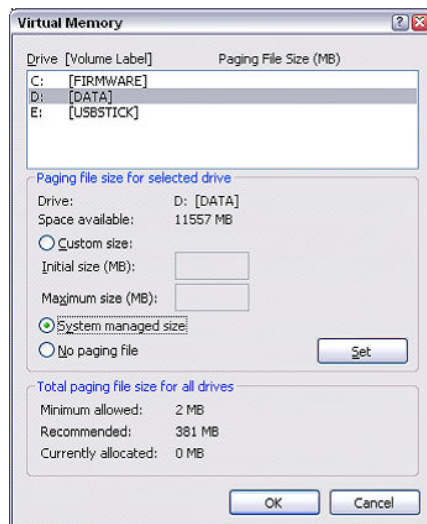

The Symantec Antivirus program can be installed.

## 2.9 LXI Configuration

LAN eXtensions for Instrumentation (LXI) is an instrumentation platform for measuring instruments and test systems that is based on standard Ethernet technology. LXI is intended to be the LAN-based successor to GPIB, combining the advantages of Ethernet with the simplicity and familiarity of GPIB.

Like GPIB, LXI determines and standardizes the way the instrument behaves in a LAN. The LXI implementation by the Rohde&Schwarz signal generators allows you to change certain LAN settings, to reset the LAN connection as well as to easily identify the instrument.

### LXI classes and LXI functionality

LXI-compliant instruments are divided into three classes, A, B and C, with the functionality of the classes hierarchically based one upon the other:

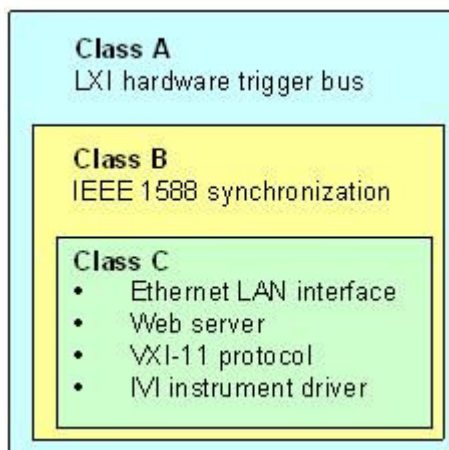

- **Class C** instruments are characterized by a common LAN implementation, including an ICMP ping responder for diagnostics. The instruments can be configured via a web browser; a LAN Configuration Initialize (LCI) mechanism resets the LAN configuration. The LXI class C instruments shall also support automatic detection in a LAN via the VXI-11 discovery protocol and programming by means of IVI drivers.
- **Class B** adds IEEE 1588 Precision Time Protocol (PTP) and peer-to-peer communication to the base class. IEEE 1588 allows all instruments on the same network to automatically synchronize to the most accurate clock available and then provide time stamps or time-based synchronization signals to all instruments with exceptional accuracy.
- **Class A** instruments are additionally equipped with the eight-channel hardware trigger bus (LVDS interface) defined in the LXI standard.



For information about the LXI standard refer to the LXI website at <http://www.lxistandard.org>. See also "News from Rohde & Schwarz, article 2006/II - 190".

Instruments of classes A and B can generate and receive software triggers via LAN messages and communicate with each other without involving the controller.

The R&S AMU complies with LXI class C and provides an integrated "LXI Status" dialog for LXI status indication and reset of the LAN configuration (LAN Configuration Initialize, LCI). To access the LXI Status dialog, press the SETUP key and select "Remote > LXI Status".

For further information, see section "LXI Status" in the Operating Manual.



#### Firmware update

After a firmware update, shut-down and re-start the instrument in order to enable the full LXI functionality.

### Default state of the network settings

According to the LXI standard, an LCI must set the following parameters to a default state.

Parameter	Value
TCP/IP Mode	DHCP + Auto IP Address
Dynamic DNS	Enabled
ICMP Ping	Enabled
Password for LAN configuration	LxiWeblfc

The LCI for the R&S AMU also resets the following parameters:

Parameter	Value
Hostname	<Instrument-specific host name>
Description	Vector Signal Generator
Negotiation	Auto Detect
VXI-11 Discovery	Enabled

The LAN settings are configured using the instrument's "LXI Browser Interface".

## 2.9.1 LXI Browser Settings

To access the instrument via the web browser:

- ▶ Type in the instrument's host name or IP address in the address field of the browser on your PC, for example "http://10.113.1.205".  
**Note:** Do not add the missing zeros in the IP address, while opening the instrument home page.

The instrument home page (welcome page) opens.

**Instrument Home Page**

**Instrument Properties**

Instrument Model	R&S AMU 200A
Manufacturer	Rohde & Schwarz GmbH & Co. KG
Serial Number	100001
Description	Rohde & Schwarz Baseband Signal Generator and Fading Simulator AMU200A 100001
LXI Class	C
LXI Version	1.1
Host Name	10.111.11.57
MAC Address	00:E0:33:63:01:08
TCP/IP Address	10.111.11.57
Firmware Revision	02.05.108 beta (Release) (2008-04-24; 15:51:12), Compass 2.1.65.0 (Release)
Current Time	Friday, 2008/04/25, 11:25:36
Current Time source	Operating System
VISA resource string	TCPIP::10.111.11.57::inst0::INSTR
Device Indicator	<input type="button" value="INACTIVE (press to toggle)"/>

**Status**

No error

© 2008 ROHDE&SCHWARZ. All rights reserved.

The navigation pane of the browser interface contains the following elements:

- "LXI"
  - "Home" opens the instrument home page. The home page displays the device information required by the LXI standard, including the VISA resource string in read-only format.
  - "Device Indicator" activates or deactivates the LXI status indication. When activated, the LXI LEDs flash, both in the browser dialog and in the LXI dialog of the connected instrument. A green LXI status symbol indicates that a LAN connection has been established; a red symbol indicates that no LAN cable is connected.
  - "Lan Configuration" allows you to configure LAN parameters and to initiate a ping, see [Chapter 2.9.2.3, "Ping Client"](#), on page 66.
  - "Status" displays information about the LXI status of the instrument.
  - "Utilities" provides access to the LXI event log functionality required by the LXI standard.
- "Instrument Control"
  - "Web Control" provides remote access to the instrument, see [Chapter 2.9.2.4, "Web Control"](#), on page 67.
- "Diagnostics"
  - "SCPI Remote Trace" records messages exchanged via the remote control interface, see [Chapter 2.9.2.5, "SCPI Remote Trace"](#), on page 68.
- "Help"
  - "Glossary" explains terms related to the LXI standard.

- [www.rohde-schwarz.com](http://www.rohde-schwarz.com) opens the Rohde & Schwarz home page.
- ▶ Press the "INACTIVE (press to toggle)" button to activate the connection.



A green flashing status LED indicates the active connection. If the LAN connection fails, the LED turns red.

The status of the LAN connection is also indicated by the "LAN Status indicator" in the "LXI Status" dialog.

For further information, see section "LXI Status" in the Operating Manual.

## 2.9.2 LAN Configuration

The "LAN Configuration" web page provides access to the parameters required for identifying the R&S AMU in the network, and allows modification.



### Password protection

Changing the LAN configuration is password-protected. The default password is *Lxi-WebIfc* (notice upper and lower case characters). This password cannot be changed in the current firmware version.

It comprises the following navigation entries.

- [IP Configuration](#)..... 64
- [Advanced LAN Configuration](#)..... 65
- [Ping Client](#)..... 66
- [Web Control](#)..... 67
- [SCPI Remote Trace](#)..... 68

### 2.9.2.1 IP Configuration

The "IP Configuration" page displays all mandatory LAN parameters.



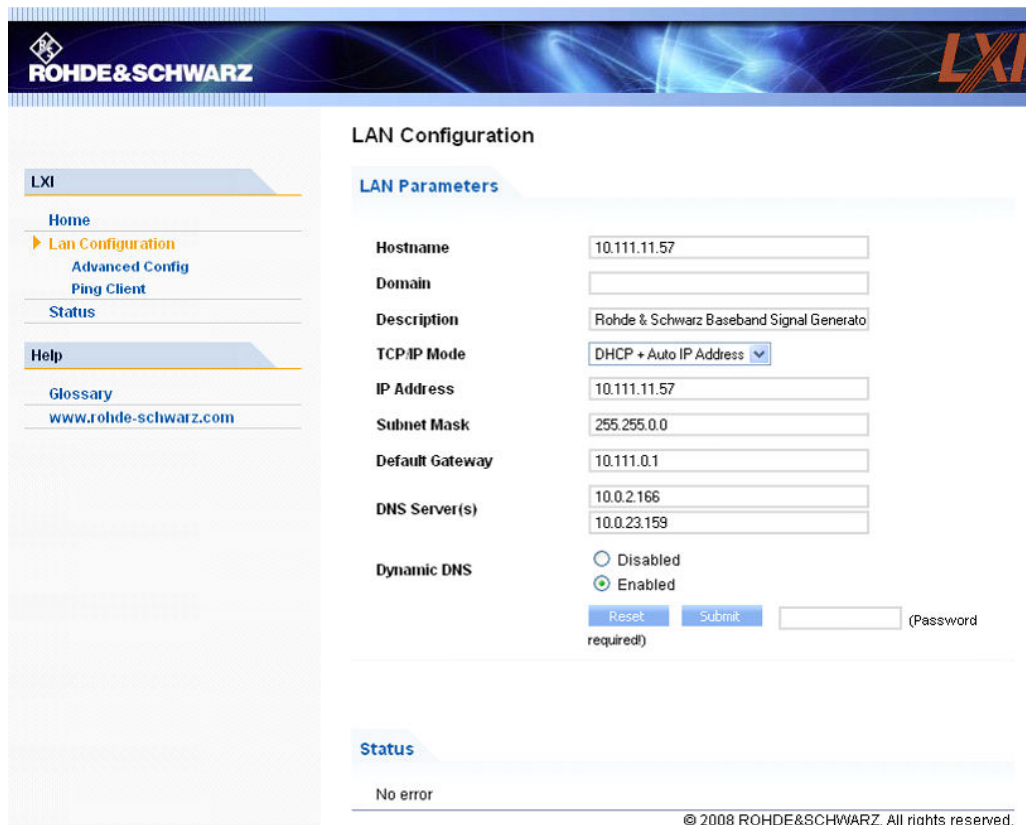

**LAN Configuration**

**LAN Parameters**

Hostname: 10.111.11.57

Domain:

Description: Rohde & Schwarz Baseband Signal Generato

TCP/IP Mode: DHCP + Auto IP Address

IP Address: 10.111.11.57

Subnet Mask: 255.255.0.0

Default Gateway: 10.111.0.1

DNS Server(s): 10.0.2.166, 10.0.23.159

Dynamic DNS:  Disabled  Enabled

Reset Submit (Password required)

**Status**

No error

© 2008 ROHDE&SCHWARZ. All rights reserved.

The "IP Address Mode" selects a configuration mode for the IP address of the R&S AMU. With static configuration, the entered IP address, subnet mask, and default gateway are used. With dynamic configuration, DHCP or dynamic link local addressing (automatic IP) are used to obtain the instrument IP address.

See [Chapter 2.6.2, "Assigning the IP Address"](#), on page 45.

### 2.9.2.2 Advanced LAN Configuration

The "Advanced Config" page provides LAN settings that are not declared mandatory by the LXI standard.

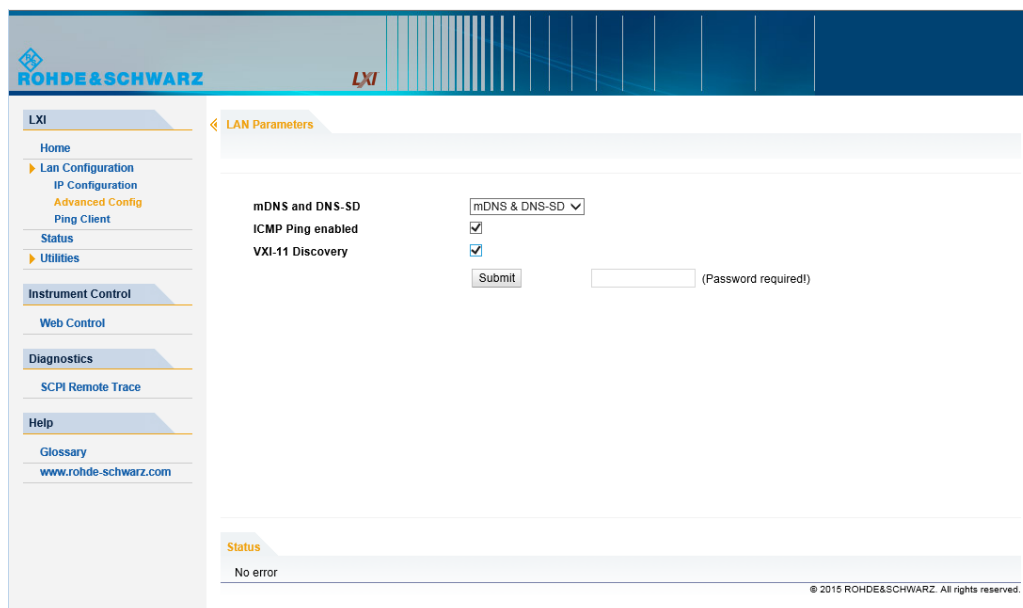

The following advanced parameters are available:

- "mDNS and DNS-SD": The additional protocols "multicast DNS" and "DNS service discovery" are used for device communication in zero configuration networks, working without DNS and DHCP.
- "ICMP Ping enabled": Must be enabled to use the ping utility. If you disable this setting, the instrument does not answer ping requests. The setting does not affect the LXI ping client. You can ping other hosts from the instrument, even if the setting is disabled.
- "VXI-11 Discovery": Must be enabled to detect the instrument in the LAN. If you disable this setting, the instrument cannot be detected by the VXI-11 discovery protocol mechanism. The setting does not affect other detection mechanisms. Setting up a VXI-11 connection via the IP address or the host name is independent of this setting.

### 2.9.2.3 Ping Client

The "Ping Client" page provides the ping utility to verify the connection between the LXI-compliant instrument and another device.

The ping is initiated from the instrument. Using the `ICMP` echo request and echo reply packets, the function checks whether the communication with a device via LAN works. Ping is useful for the diagnosis of IP network or router failures.

The ping utility is not password-protected.

To initiate a ping from the instrument to the device:

1. Enable "ICMP Ping" on the "Advanced LAN Configuration" page.
2. Select the "Ping Client" page.

3. In the "Destination Address" field, enter the IP address of the device to be pinged (without the ping command and without any further parameters), e.g. *10.113.1.203*.
4. Select "Submit".

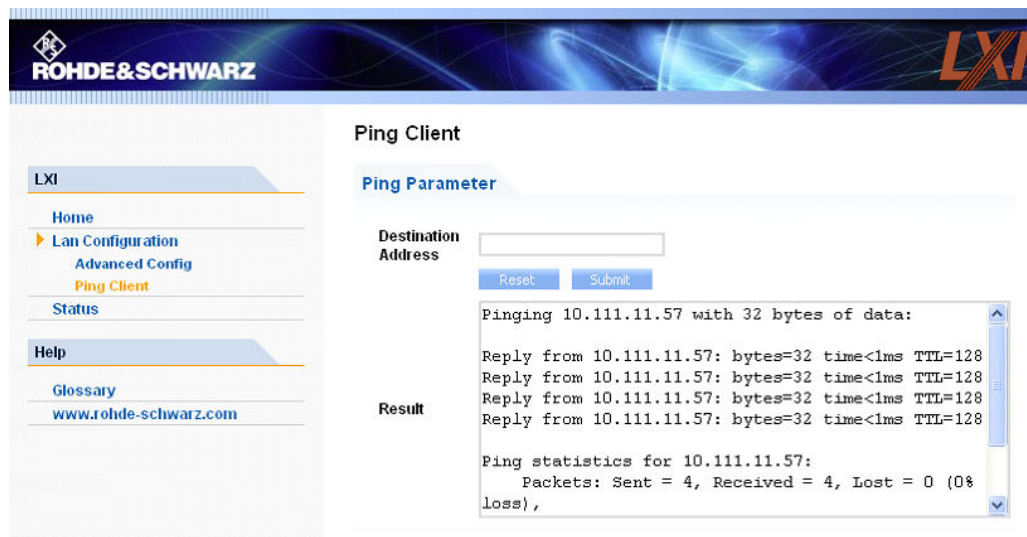

#### 2.9.2.4 Web Control

The web control functionality provides remote operation via VNC using a Web browser (with HTML5). This mode does not require additional installation or activation. The VNC protocol allows simultaneous operation from several remote devices. The instrument remains locally operable.

The GUI of the R&S AMU is visible. To perform the settings, you can operate the instrument as with the manual control. The instrument controls are available via the front panel simulation. File upload and download between the instrument and the remote PC is also available.

##### Starting a Remote Control via the LXI web browser

This section assumes that the instrument and the controller PC are connected in the LAN.

1. Start a web browser that supports html5 (W3C compliant).
2. Enter the IP address of the R&S AMU in the browser's address bar.  
The R&S AMU's welcome page is displayed.
3. In the navigation pane, select "Instrument Control" > "Web Control".  
Remote access to the instrument requires the password. The default password is *instrument*.
4. Enter the password and confirm with the ENTER key.  
After the connection is established, the current screen of the R&S AMU is displayed in the browser window.

- Use the mouse cursor and keyboard to access the functionality of the instrument as you would directly perform the settings on the instruments front panel.

### 2.9.2.5 SCPI Remote Trace

The remote trace functionality allows you to trace input and output strings at the remote control interface of the R&S AMU.

A recorded trace (message log) can be evaluated directly in the dialog. Use the highlighting and navigation functions provided in the lower toolbar to locate error messages and messages containing arbitrary search strings. You can also export the message log to a \*.CSV file and evaluate the file using a suitable program.

To trace and display messages:

- In the navigation pane, select "Diagnostics" > "SCPI Remote Trace".
- In the toolbar bar of the "SCPI Remote Trace" page, select "live mode" > "on" and "logging" > "on".  
"live mode > on" displays all commands and responses, and "logging > on" also traces messages.
- If you now control the R&S AMU with SCPI commands, using an appropriate tool, the SCPI remote trace records the information sent and received.

rec	MT	message
0	>	*idn?
0	<	Rohde&Schwarz, <instrument, 12345,67890>
0	>	*opt?
0	<	0
0	>	*Freq?
0	<	1000000000
0	>	*LEV?-20
0	>	*LEV?
0	<	-20

Status  
20 live records received

© 2015 ROHDE&SCHWARZ. All rights reserved.

The function records all sent commands, received responses and messages, and stores them in an internal database. If "live mode" is disabled, you can display the recent traces upon request, using the "refresh" button. You can also store the log in a file.

**Note:** The diagnostics functionality will be extended in later releases, e.g. to download or upload SCPI command files from / to the instrument.

## Toolbars

The toolbar at the top of the dialog provides basic settings and functions.

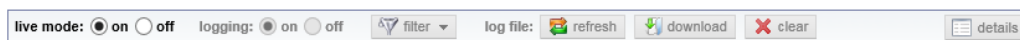

- "Live mode" / "logging": If logging is switched on, messages are traced. They are stored in an internal database and can be displayed upon request, using the refresh button (live mode off) or they can be displayed automatically (live mode on).
- "Filter": applies a filter to columns and/or rows when working (live mode off)
- "Refresh": reads the message log from the internal database and displays it
- "Download": stores the SCPI trace log to a \*.CSV file
- "Clear": deletes all message log entries in the database and on the screen
- "Details": displays details of the selected message, for example an SCPI command in hex format (also possible by double-clicking a message)

## Columns

The following columns are available if no column filter is applied:

- "Rec": record number of the message within the message log
- I: number of the subinstrument
- "MT": indicates the type of the message. Possible values and related message contents are:
  - > = incoming command
  - < = outgoing response to a query
  - E = error message, highlighted by red color
  - T = execution time, i.e. time required by the instrument to process the command internally
- "message": indicates the type of the message. Possible values and related message contents are:
  - > = incoming command
  - < = outgoing response to a query
  - E = error message, denoted in red
  - T = execution time, i.e. time required by the instrument to process the command internally



## 3 Getting Started

This section helps you to get familiar with the R&S AMU and provides an introduction to the general concept of the instrument with a sample of the possible application fields as well as a description of the main blocks in the signal generation flow.

This section also explains the operating concept in general and includes a brief introduction to operation by a step-by-step description of the configuration. The example is intended to provide a quick overview of the settings provided. No additional equipment is required.

### 3.1 Brief Introduction to the Instrument's Concept

The R&S AMU provides an entirely digital baseband section for generating I/Q signals. The R&S AMU uses internal and/or external baseband signal sources and simulates various interfering signals in the baseband, e.g. fading, noise and I/Q impairment. Digital signals can be generated internally in accordance with several digital standards or user defined signal characteristics. Analog or digital baseband signals can be fed into the signal path. The signals are generated in realtime or with the aid of the Arbitrary Waveform Generator. The digital data streams can be output directly and are converted to analog I/Q baseband output signals.



The R&S AMU may contain two paths; through the user documentation, the first being is called path A and the second path B, respectively.

---



The signals generated in different basebands blocks can be routed from path A to path B and vice versa and can be added. Each baseband path enables independent output of the modulated signals (analog in/out, digital in/out, analog differential out).

---

For a detailed description of the blocks, refer to [Chapter 3.3, "Baseband Section"](#), on page 78.

The **operating concept** of the R&S AMU employs the following three ways of instrument control:

- Manual operation
- Remote control
- Remote access

#### Manual Operation

The R&S AMU can be entirely operated from the front panel. Peripherals such as mouse or keyboard can be connected but are not essential.

The R&S AMU is equipped with an intuitive user interface. The central element of the display is the block diagram that shows the signal flow and processing from the left on the display to most right, i.e. the generated signal can be seen at a glance.

Each block represents a functional unit of the instrument. Thus the user always knows the position at which a parameter has an effect in the signal flow. The main settings of a block are indicated in the block. The interconnection of employed inputs and outputs is also shown. The user is thus always informed about the connection of inputs and outputs in the signal flow and where they can be configured. A window is opened for each menu where parameters can be set. When the window is opened, an entry is made in the "Winbar" below the display. All open menus are of equal priority (not modal) and can be accessed any time.

The block diagram in the figure below shows a fully equipped instrument.

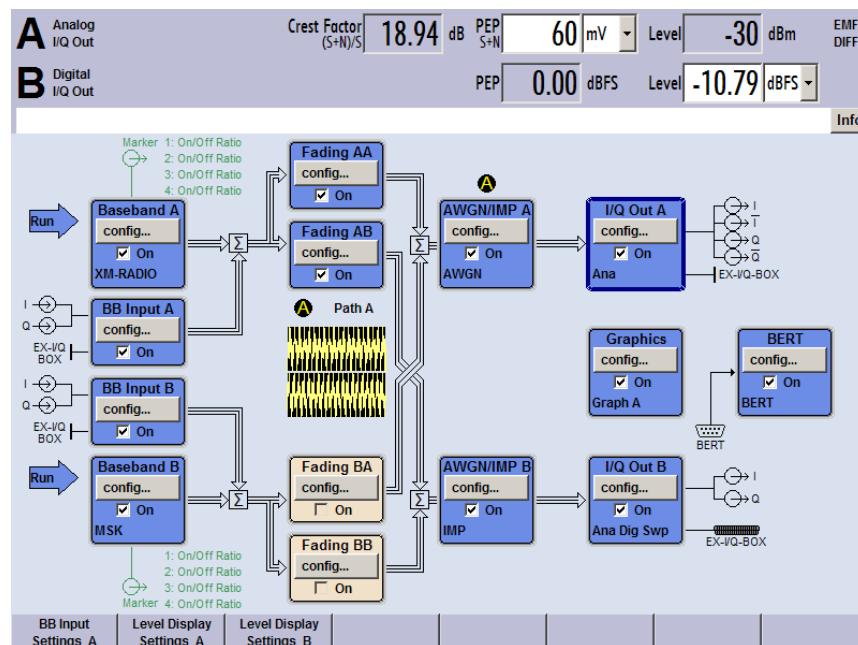

Figure 3-1: Block diagram of a fully equipped R&S AMU

With the aid of the rotary knob, the user can navigate in the block diagram and the dialogs, and can operate the instrument with one hand. The cursor is moved line by line through the block diagram or dialog. Turning the button clockwise advances the cursor. The selected block can be activated or deactivated with the TOGGLE key. Active blocks are highlighted by a colored background.

The instrument comprises a comprehensive info and help system. Context-sensitive help can be called any time with the HELP (F1) key. The help system indicates the currently selected parameter and offers additional services such as cross references, index and contents. The content of the help system corresponds to the operating manual of the instrument.

Warning and conflict messages caused by incorrect operation as well as further information are displayed in the "Info" line. A complete list of existing conflicts is displayed when the INFO (CTRL+I) key is pressed. Additional information on entries can be requested from the help system. The history function permits display of all messages.

Assistants simplify the completion of tables. After data entry in the assistant, the table is modified only after the "Accept" button has been pressed. Pressing the "Accept" button also stores the assistant data.



For an introduction into the manual operating of the instrument, detailed operating instructions and an overview of menus refer to [Chapter 4, "Manual Operation"](#), on page 95.

For an indepth description of the dialog boxes and the instrument functions refer to section [Chapter 5.1, "Overview of Instrument Functions"](#), on page 133.

### Remote Control

Remote control is an operation of the instrument by means of remote control commands or programs that automatize repeating settings. The instrument is connected to a computer running the program.

The R&S AMU supports various remote control connections:

- Connecting the instrument to a (LAN) network
- Using the LXI browser interface in a LAN network
- Connecting a PC via the IEC-bus (IEEE 488) interface



**Tip:** For remote control over LAN, you can use the R&S VISA (Virtual Instrument Software Architecture) library provided for download at the Rohde & Schwarz website <http://www.rohde-schwarz.com/rsvisa>.

This way of operation and the instructions how to set up a connection for remote control are described in the [Chapter 6, "Remote Control Basics"](#), on page 381. The description of the remote control commands is provided in [Chapter 7, "Remote Control Commands"](#), on page 425.

### Remote Access

Remote access is the operating of the instrument from a remote computer. Both the R&S AMU and the computer are connected in a LAN.

**Remote access** in contrast to **remote control** does not use remote-control commands but a separate software which is installed on the remote computer. After its start, the software simulates the user interface of the instrument. The instrument can thus be operated from the remote computer as on the unit itself. The individual functions are operated using the mouse and keyboard. Specific instrument functions can be executed using specific key combinations on the keyboard or a front panel key emulation that can be operated with the mouse.

This way of operation and the instructions how to set up a connection for remote access are described in [Chapter 2.7, "Remote Access via an External Controller"](#), on page 48.

## 3.2 Applications of the Instrument

The modular design of the R&S AMU allows the instrument to be equipped with two paths. This allows a multitude of applications to be performed for which several signal

generators were previously required. Up to four baseband sources, two internal generators and two external inputs can be installed. A few examples are given below.

Possible applications:

- Generation of a baseband signal of different standards (realtime) or via arbitrary waveforms
- Addition of real time signals of different standards, e.g. GSM/EDGE and 3GPP FDD
- Baseband module tests with differential and digital signals
- BER Tests of baseband modules
- Design and tests of I/Q modulators
- Generation of a wanted signal and an interfering signal for tests on baseband sections of receivers
- Generation of multicarrier signals with real time components up to 80 MHz bandwidth
- Generation of fading and noise scenarios with external I/Q signals
- Signal Source for early development stage hardware simulators
- Development of new communication systems (e.g. LTE)
- Test of diversity techniques and real time baseband fading

### 3.2.1 Generation of Digitally Modulated Signals

The main field of application of the R&S AMU is the generation of digitally modulated signals. In the instrument, a digitally modulated signal can be generated in several ways.

#### Internally generated I/Q signal

The I/Q signal is generated internally in the R&S AMU. One or two baseband generators can be installed. The signals produced by the two generators can be added (possibly with frequency offset).

In this case the instrument must be equipped with

- at least one baseband generator (option R&S AMU-B9/-B10/-B11) and
- at least one baseband main module (option R&S AMU-B13).

Fading scenarios can be created with the aid of a fading module (option R&S AMU-B14, Fading Simulator) and option R&S AMU-B15, Fading Simulator Extension).

A digital/analog converter converts the internal digital baseband signals into analog I/Q output signals. The output of the analog signal can be single ended or differential (option R&S AMU-B16; Differential I/Q Output). For the digital signal output a baseband digital I/Q output (option R&S AMU-B18, Baseband Digital I/Q Output) is available.

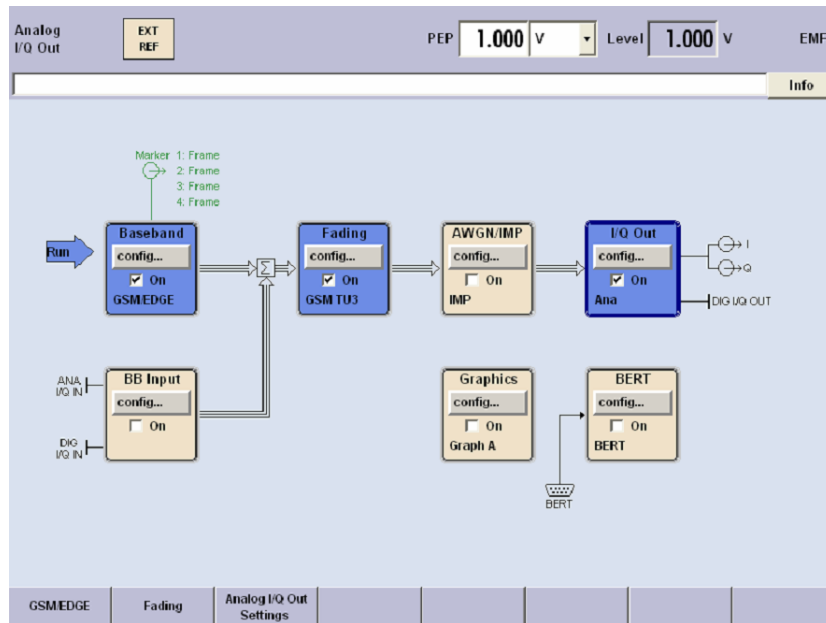

Figure 3-2: Operation of the R&S AMU with I/Q signals generated by the internal baseband generator

### Externally generated I/Q signal

The I/Q signal is generated by an external instrument and coupled in via the baseband input module (option R&S AMU-B17, Baseband I/Q Input (digital/analog)). With this baseband input module, analog or digital signals can be fed into the R&S AMU. The frequency of the signals can be shifted, and if options are installed for internal baseband generation, the external and the internal baseband signals can be added with variable level ratio. If the R&S AMU is equipped with a fading simulator (option R&S AMU-B14, Fading Simulator and option R&S AMU-B15, Fading Simulator Extension), the signals can be faded. The fading module also processes external I/Q signals.

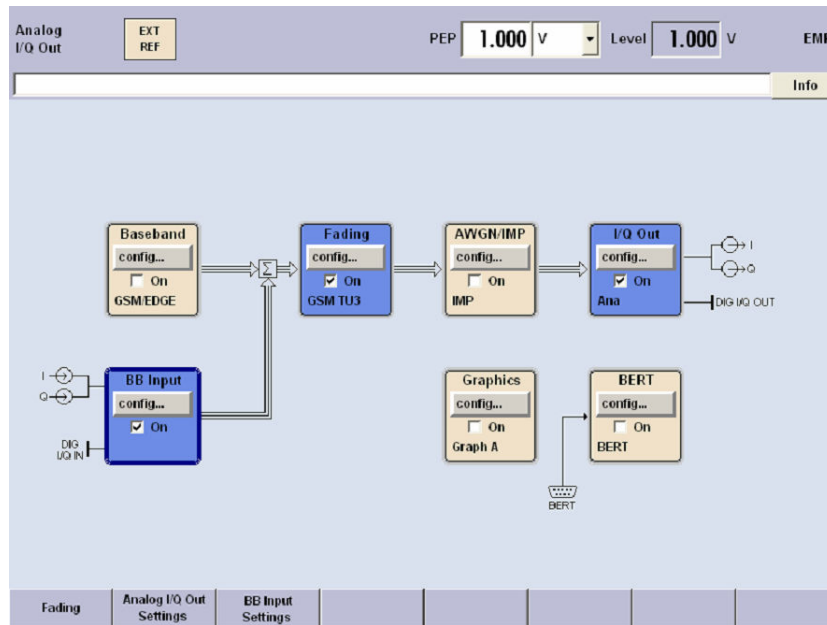

Figure 3-3: Operation of the R&S AMU with externally applied I/Q signals.

### 3.2.2 One Path Instrument

A one-path R&S AMU requires at least one Baseband Main Module (option R&S AMU-B13) and a signal source. The signal source may be either the internal Baseband Generator (option R&S AMU-B9/-B10/-B11) or the external Baseband I/Q Input (option R&S AMU-B17).

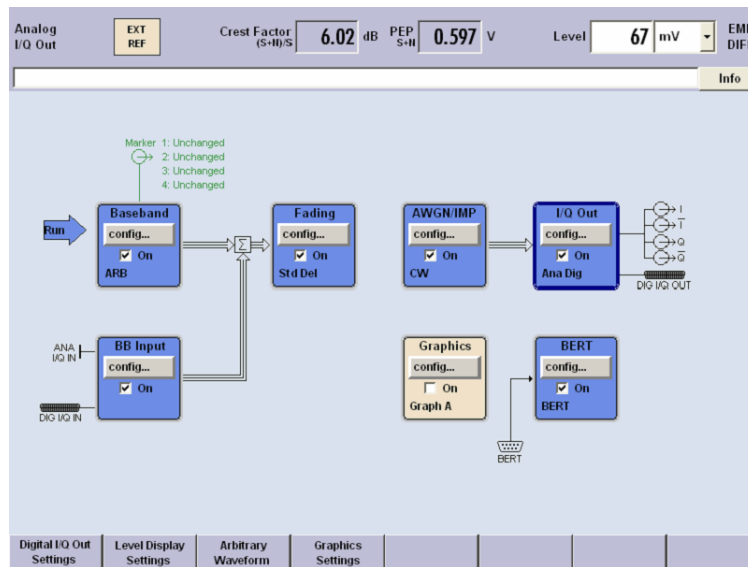

Figure 3-4: Operation of R&S AMU with one baseband main module and two baseband sources.

Additionally the following options can be part of a one-path configuration:

- Further baseband sources (up to a configuration with two internal Baseband Generators (option R&S AMU-B9/-B10/-B11) and one external Baseband I/Q Input (option R&S AMU-B17))
- Addition of real time signals of different standards, e.g. GSM/EDGE and 3GPP FDD
- Generation of multicarrier signals with real time components
- The Fading Simulator (option R&S AMU-B14) and the Fading Simulator Extension (option R&S AMU-B15)
- Additive White Gaussian Noise AWGN (option R&S AMU-K62)
- Bit and Block Error Rate Measurement BERT (option R&S AMU-K80)
- One Differential I/Q Output (option R&S AMU-B16)
- One Digital I/Q Output (option R&S AMU-B18)



One-path instruments cannot use a second external Baseband I/Q input option.

### 3.2.3 Two Path Instrument

A two-path R&S AMU requires at least two Baseband Main Modules (option R&S AMU-B13) and two signal sources. The signal sources may be the internal Baseband Generators (option R&S AMU-B9/-B10/-B11) or the external Baseband I/Q Inputs (option R&S AMU-B17).

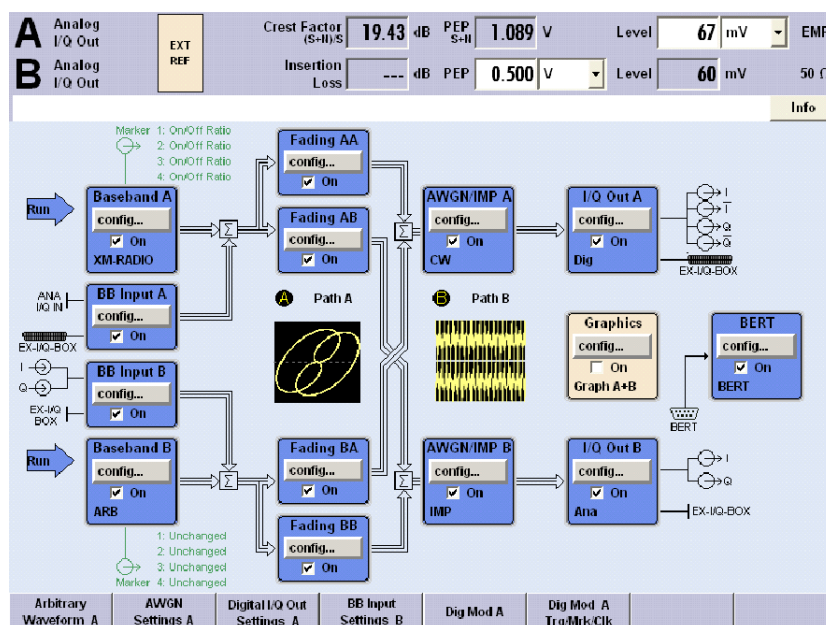

Figure 3-5: Operation of R&S AMU as a fully equipped two-path instrument

Additionally the following options can be part of a two-path configuration:

- Further baseband sources (up to a configuration with two internal Baseband Generators (option R&S AMU-B9/-B10/-B11) and a second external Baseband I/Q Input (option R&S AMU-B17))
- Addition of real time signals of different standards, e.g. GSM/EDGE and 3GPP FDD
- Generation of multicarrier signals with real time components
- The Fading Simulator (option R&S AMU-B14) and the Fading Simulator Extension (option R&S AMU-B15)
- Additive White Gaussian Noise AWGN (option R&S AMU-K62)
- Bit and Block Error Rate Measurement BERT (option R&S AMU-K80)
- A second Differential I/Q Output (option R&S AMU-B16)
- A second Digital I/Q Output (option R&S AMU-B18)

### 3.3 Baseband Section

The baseband section of the R&S AMU is fully digital and contains the hardware for generating and processing I/Q signals.

The baseband section may contain two paths.

For detailed information on available options, refer to the R&S AMU data sheet and the R&S AMU configuration guide.

Up-to-date information is available at R&S AMU homepage on the internet <http://www.rohde-schwarz.com/product/amu200a.html>.

#### **Baseband generator (option R&S AMU-B10)**

The generator produces baseband signals. It contains modules for real time signal generation and an arbitrary waveform generator (ARB).

The different baseband options feature a different ARB memory size (see data sheet). But apart from the memory size, all options have the same functionality and are installed alternatively.

One or two baseband generators can be fitted in an R&S AMU and operated separately. Signals from the baseband generators can be routed from path A to B and vice versa, and added (possibly with frequency offset).

The option Baseband Generator contains real time Custom Digital Modulation and ARB. Software options providing various digital standards are offered in addition. Option R&S AMU-K40, for instance, generates signals to GSM/EDGE standard, option R&S AMU-K42 signals to 3GPP FDD standard.

#### **Baseband input module (option R&S AMU-B17)**

With the aid of this module, external analog or digital I/Q signals can be fed into the R&S AMU. For two-path instruments, an external signal can be connected to baseband

path A or path B. For one-path instruments, the baseband input module is permanently linked to path A. Up to two baseband input modules can be applied. In two-path instruments the signal of the first baseband module can be routed to path A, path B or to both paths. The signal of the second baseband input module is firmly connected to path B. External and internal baseband signals can be added with variable level ratio. The I/Q signals can be further processed: e.g. the frequency of the signals can be shifted, noise can be added and they can also be faded.



The R&S AMU-B17 option can be used together with the R&S® EX-IQ-BOX digital interface module, providing a versatile digital baseband interface with various formats.

---

The baseband main module can be installed twice, for each of both paths A and B respectively.

The module converts the digital signal to an analog I/Q signal and routes it to the I/Q output. The analog I/Q signal can be output either single ended, or differential.

This module also offers digital I/Q impairment functions. The I/Q signal can be deliberately corrupted, e.g. for testing the receiver quality.

All frequency and time settings are coupled to the internal reference frequency.

#### **Additional White Gaussian Noise (option R&S AMU-K62)**

Additive white noise, which may be required for instance for measurements on mobile radio base stations, can be produced with the AWGN software option (R&S AMU-K62).



If the noise generator is used, a frequency offset cannot be added to the wanted signal. If two options R&S AMU-B13 are installed (paths A and B), AWGN can be generated either on path A or B with one R&S AMU-K62 option. If AWGN is to be generated on paths A and B simultaneously, two options R&S AMU-K62 must be installed.

---

#### **Fading module (option R&S AMU-B14)**

This module enables fading effects to be produced on baseband signals in real time. In the case of TDMA fading, up to 20 fading paths (40 fading paths with option R&S AMU-B15) can be created simultaneously.

Software option R&S AMU-B71 comprises the 3GPP dynamic fading configurations moving propagation and birth-death propagation as well as the fine delay fading configurations offering enhanced delay resolution.



At least one fading simulator, option R&S AMU-B14 must be installed. If both options R&S AMU-B14 and the R&S AMU-B15 are installed (signal path A and B), dynamic fading and enhanced resolution can be used either on signal path A or B with one option R&S AMU-K71 option. If dynamic fading and enhanced resolution is to be used on signal paths A and B simultaneously, two options R&S AMU-K71 must be installed.

---



**Differential output module (option R&S AMU-B16)**

The differential output module (option R&S AMU-B16) provides symmetrical signals for differential outputs. The operating points of the inputs can be set and balanced by an offset between inverting and non-inverting output. This module can be installed twice (for path A and path B).

**Digital output module (option R&S AMU-B18)**

The R&S AMU can be equipped with a standardized digital I/Q interface (LVDS) for online transfer of digital I/Q data. The digital output module (option R&S AMU-B18) enables the digital output of the I/Q baseband signal.

This module can be installed twice (for path A and path B).



The R&S AMU-B18 option can be used together with the R&S® EX-IQ-BOX digital interface module, providing a versatile digital baseband interface with various formats.

**3.3.1 Description of Individual Diagram Blocks of the Baseband Section**

The baseband section of the R&S AMU comprises two paths (paths A and B). Therefore, if two baseband generators are available, two baseband signals can be processed independently of each other. Routing from path A to path B and vice versa is also possible, but not after the "IMP" or "AWGN/IMP" block.



Each function block can be activated or deactivated with the "ON" check box (on/off toggling).

The ON/OFF TOGGLE key at the front panel (see ["TOGGLE"](#) on page 22) switches the currently selected block on or off.

A detailed description of the blocks is provided below.

**Baseband A block**

In this block, the (first) baseband source is configured and activated. The block is displayed only if a baseband generator is available in the instrument.

Depending on the installed software options, various digital standards, user-configured digital real time modulation or the built-in waveform generator (ARB) can be selected. The selected modulation is displayed in the block.

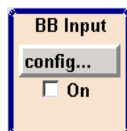
**External Baseband In block**

This block controls the baseband input module for external I/Q signals. The block is displayed only if the baseband input module (option R&S AMU-B17) is installed. External I/Q signals can be applied to the analog I/Q input. The output of the baseband input module can be connected to baseband path A or (if available) path B provided at least one baseband main module or one fading module is installed. Otherwise the baseband input module is permanently linked to path A. (The reason is that the baseband input module does not contain a router chip. For switchover, at least one baseband module with a router chip is required).



**Note:** If one baseband path is configured (path A), the external baseband signal BB Input B is connected to this path. If two baseband paths are configured the external baseband signal BB Input B is permanently routed to path B.



### Baseband B block

Configures the second baseband source (if installed). The block is displayed only if the instrument contains two baseband generators. Depending on the installed software option, various digital standards, user-configured digital real time modulation or the built-in waveform generator (ARB) can be selected.

**Note:** If two baseband generators are installed and two signals of the same standard (e.g. GSM/EDGE) should be output simultaneously, the two associated software options must also be installed (in this case R&S AMU-K40).

If only one R&S AMU-K40 is installed and GSM/EDGE is selected in the first baseband generator, the second baseband generator is disabled for GSM/EDGE.

However, a software option is not tied to a specific baseband generator. In our example, either the first or the second baseband generator can output a GSM/EDGE signal.



### Fading block

This block controls the fading module. It is displayed only if a fading simulator (option R&S AMU-B14) is installed. Signal routing at the output of the fading module is also configured in this block.

For instance, two-channel fading can be selected if the instrument contains two baseband paths and two faders (option path extension, R&S AMU-B15).

**Note:** Under certain signal routing conditions only one fader can be activated. At least one fading simulator, option R&S AMU-B14 must be installed. If both options R&S AMU-B14 and the R&S AMU-B15 are installed (signal path A and B), dynamic fading and enhanced resolution can be used either on signal path A or B with one option R&S AMU-K71 option. If dynamic fading and enhanced resolution is to be used on signal paths A and B simultaneously, two options R&S AMU-K71 must be installed.



### AWGN/IMP A block

In this block (digital) I/Q impairments for the baseband path can be set. With the aid of the software for AWGN generation (option R&S AMU-K62), an (additive) noise signal can be produced.

AWGN and impairments can be activated independently of each other in the appropriate menus. The settings are displayed in the block. The entire block can be activated or deactivated. If the block is deactivated, the signal passes through the block unchanged.



### AWGN/IMP B block

This block is displayed only if two baseband main modules (option R&S AMU-B13) are installed. In this block (digital) I/Q impairments for baseband path B can be set. With the aid of the software for AWGN generation (option R&S AMU-K62), an (additive) noise signal can be produced in path B.

If a noise signal should be applied to path A and B simultaneously, two software options R&S AMU-K62 are required.



### Graphics block

With this block, the baseband signal (of path A or B) can be graphically displayed in real time. The block is displayed only if at least one baseband main module is installed.



### BERT block

In this block an integrated bit and block error rate tester can be set. The bit error tester makes it possible to evaluate a signal demodulated and decoded by a DUT by measuring the bit error rate. The data used to drive the DUT can be generated by the R&S AMU or an user-defined external source. In addition, the block error rate measurement can be used to verify CRC checksums.

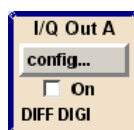

### I/Q OUT A/B blocks

These blocks are used to configure the digital and analog I/Q outputs of path A. Configurations like level display, output type, analog settings and digital settings can be performed in the corresponding menus. I and Q components can also be swapped (I/Q Swap).

The status line in a block displays the currently active output types, e.g. "DIFF DIGI" denotes that the I/Q baseband signal is provided by the analog output (in differential mode) and also by the digital output.

**Note:** The BASEBD ON/OFF key switches the baseband output signal on and off. In the two-path mode this key switches all signals off. A second stroke restores the status that was active before the last switch off.

## 3.4 Example of Setup

This section provides an example on how to configure the instrument for generating a fading signal in accordance with a standard GSM-TU 3 (12Path) and a carrier frequency of 904.5 MHz (virtual RF).

### Configuring and displaying a GSM-TU3 signal with fading

To generate and display the GSM signal, proceed as follows:

1. Activate default (preset) state.  
Press the PRESET key to set a defined instrument state.

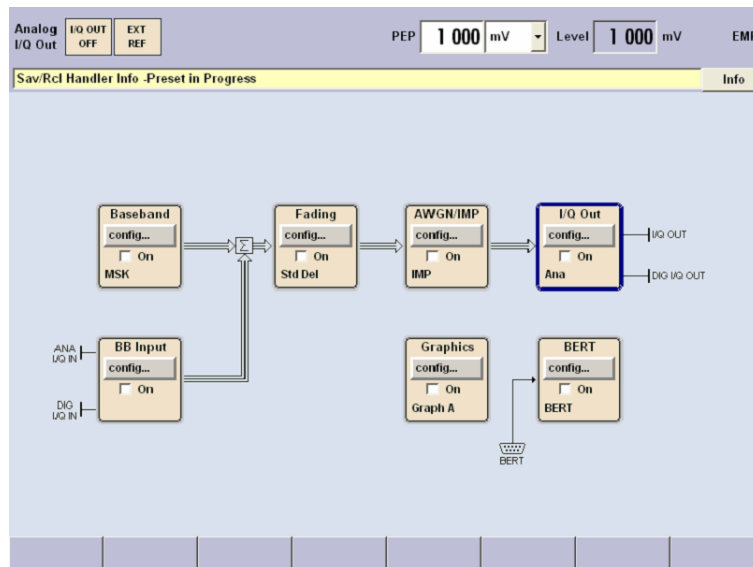

2. Select and activate the GSM/EDGE signal generation.
  - a) Turn the rotary knob and select the "Baseband A" block.

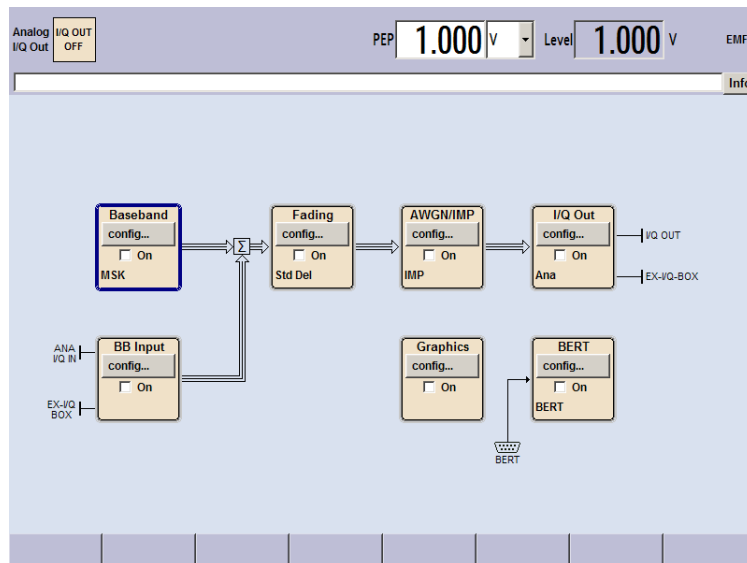

- b) Press the rotary knob to open the menu where the GSM/EDGE modulation can be selected (different modulation modes are available depending on the options installed).

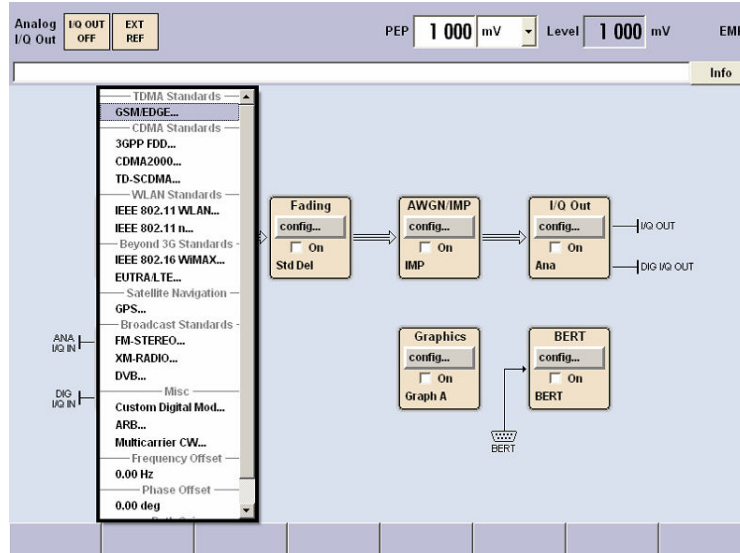

- c) Turn the rotary knob and highlight "GSM/EDGE..."

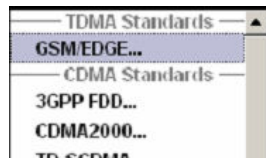

Press the rotary knob to open the "GSM/EDGE" dialog.

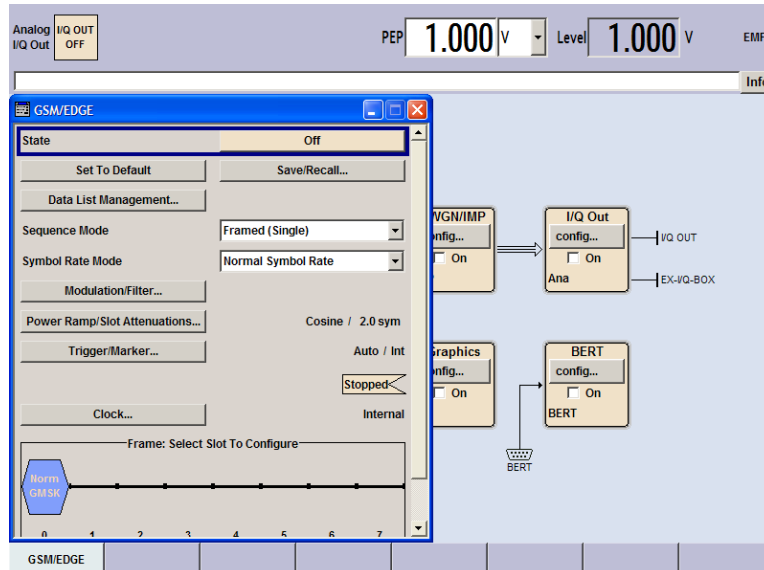

- d) Turn the rotary knob to select parameter "State", press the rotary knob to switch on GSM modulation with default settings.

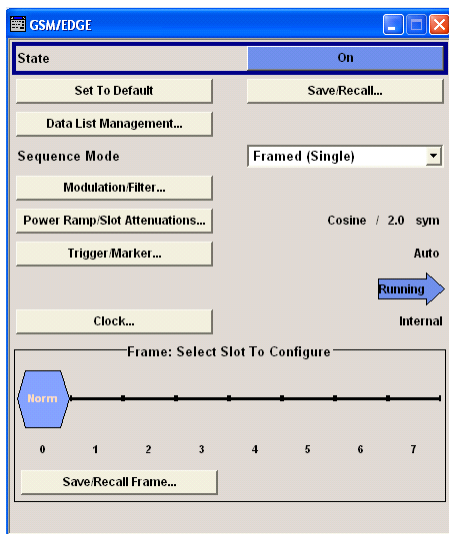

- e) Press the DIAGRAM key to display the complete block diagram.

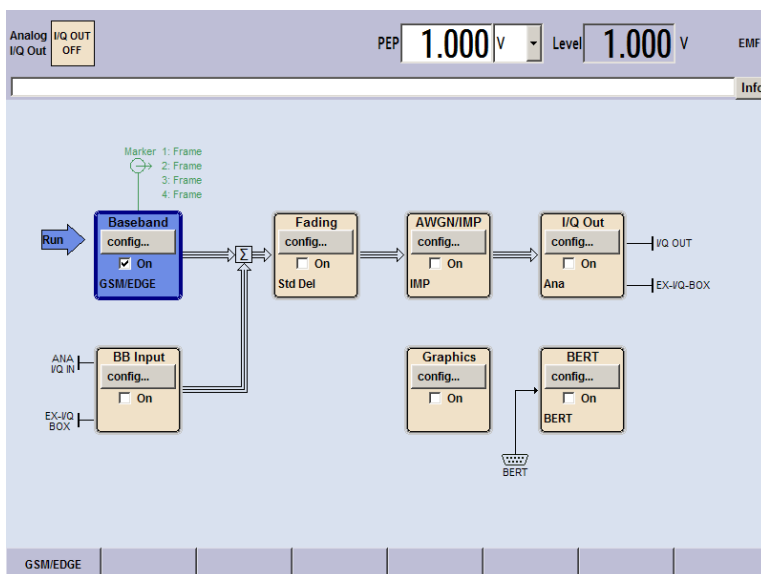

To indicate the active state, the "Baseband" block is displayed in blue and the checkbox "On" is ticked.

The entry in the Winbar indicates that the "GSM/EDGE" dialog is still open in the background.

- f) To display the dialog in the foreground, press the associated softkey below the "Winbar".

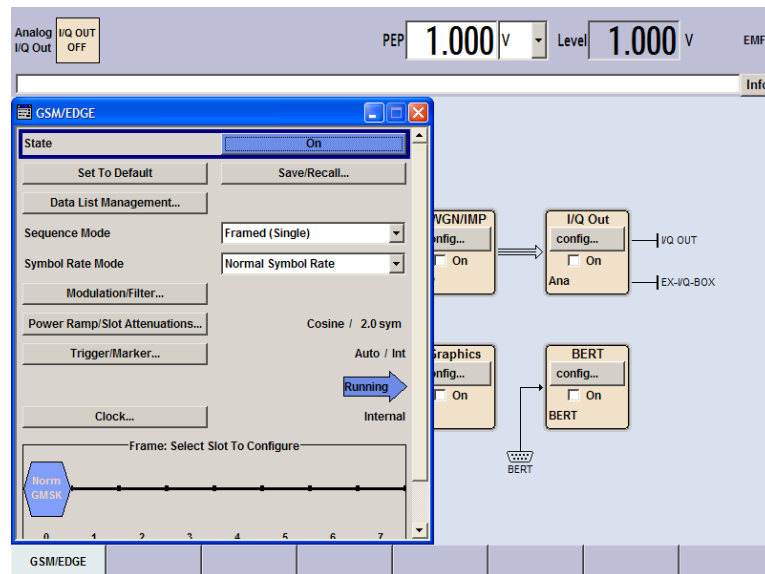

- g) Press the HIDE key to minimize the dialog again.

The "Fading", "AWGN/IMP" and "I/Q OUT" blocks are not yet active.

3. Configure and activate the fading standard GSM TU 3 (12Path).

a) Turn the rotary knob and select the "Fading" block.

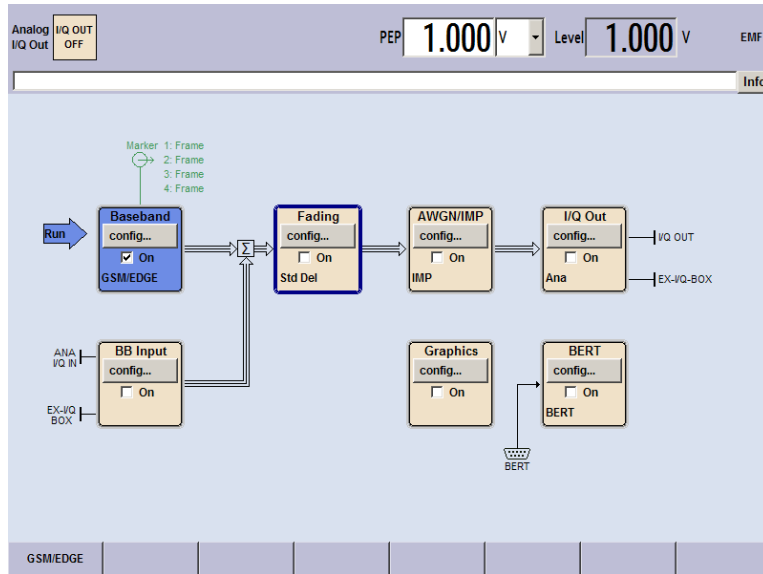

Press the rotary knob to activate the menu for fading settings.

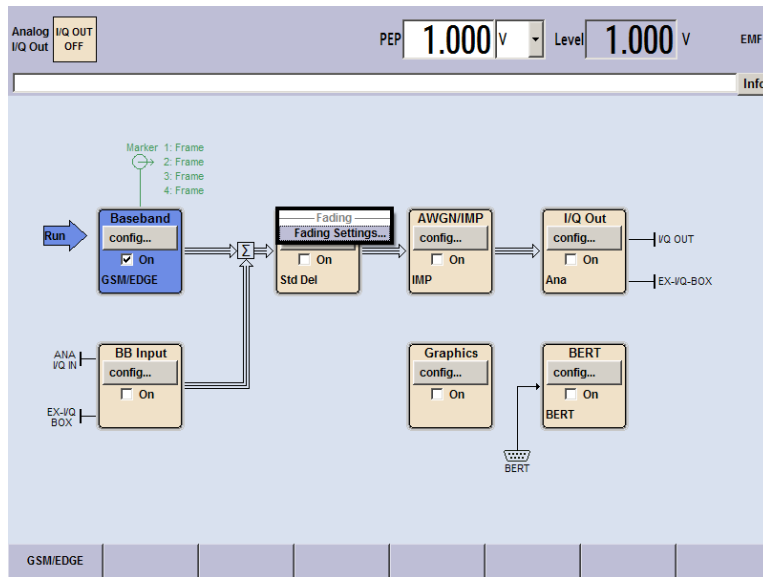

- b) Select Fading Settings, and press the rotary knob again to open the fading settings dialog.

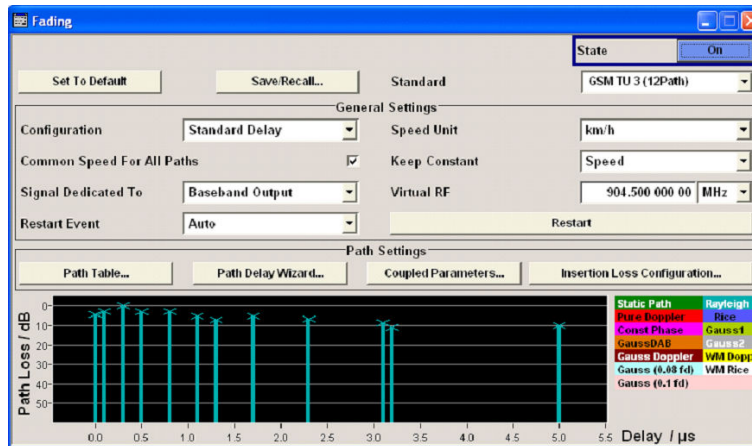

- c) Turn the rotary knob to select the Standard field.

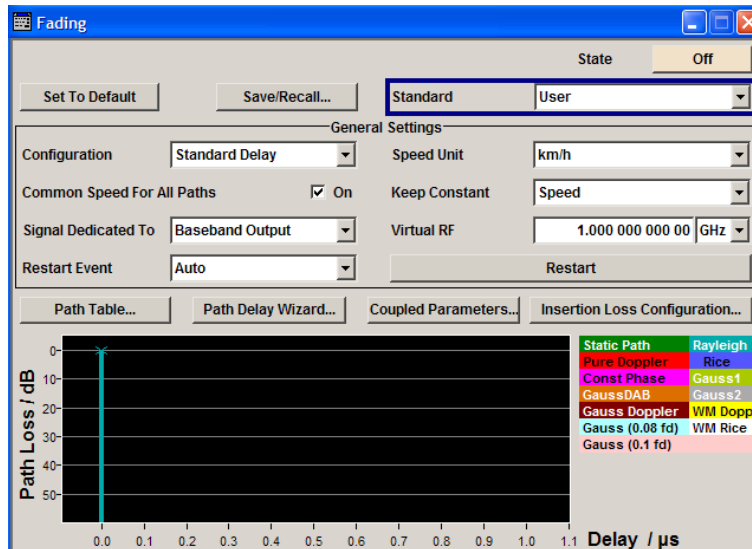

- d) Press the rotary knob to open the "Standard" selection list.



e) Select "GSM" by turning the rotary knob.

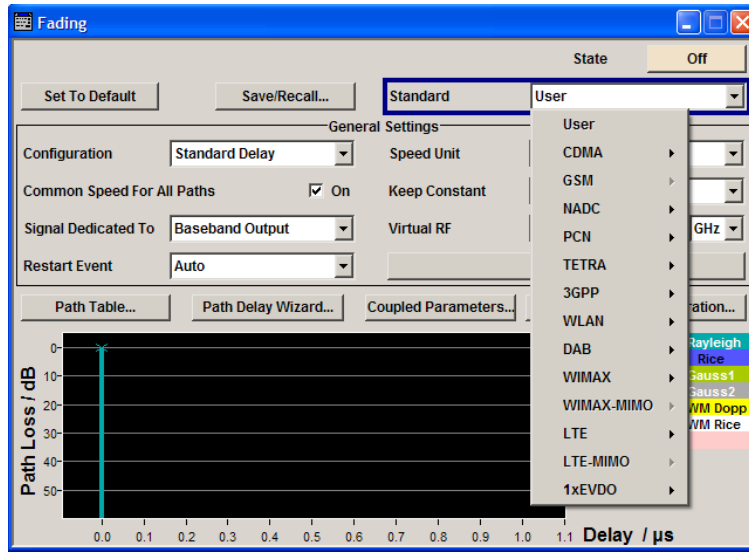

f) Open the "GSM" selection list, the select list GSM850/900 and select GSM TU 3 (12Path) in the same way.

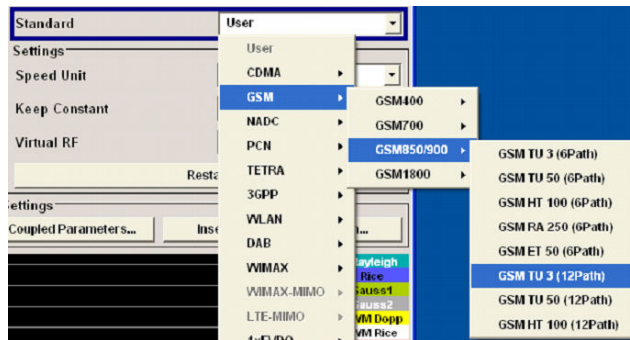

g) Press the rotary knob to confirm the selection.



The fading simulation of the standard "GSM TU 3 (12Path)" is preset.

h) Turn the rotary knob and select the Virtual RF field.

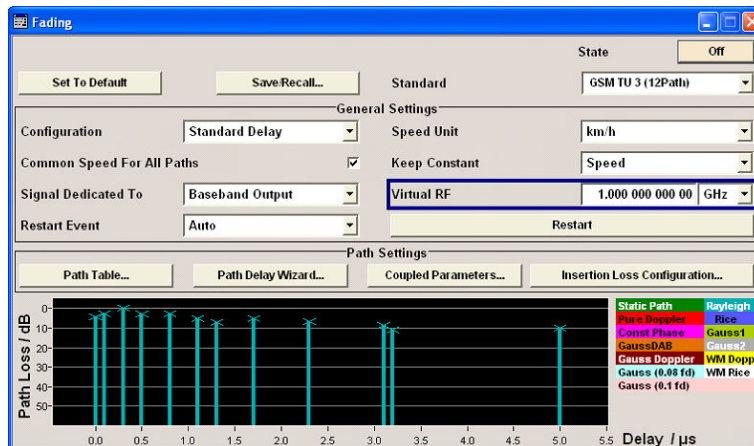

- i) Press the rotary knob to activate the editing mode.
- j) Enter the frequency value 904,5 MHz with the aid of the numeric keypad and the unit keys.



- k) Select the "State" field by turning the rotary knob.
- l) Press the rotary knob to switch on the GSM fading simulation.

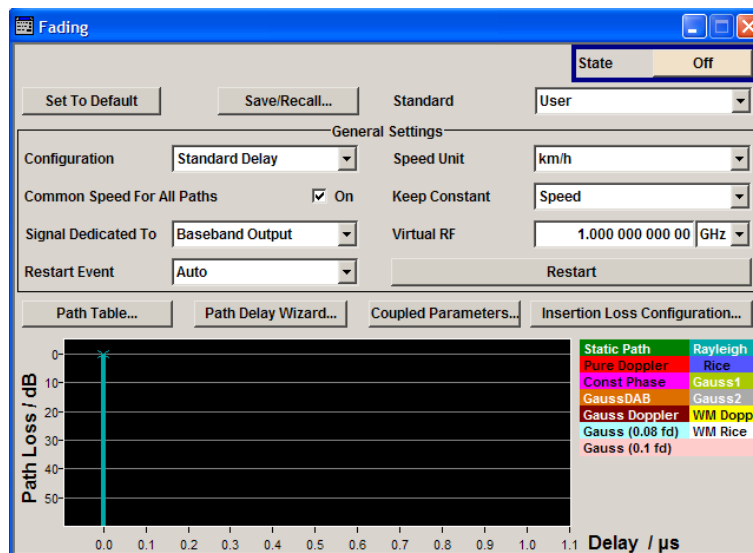

- m) Press the DIAGRAM key to display the complete block diagram.

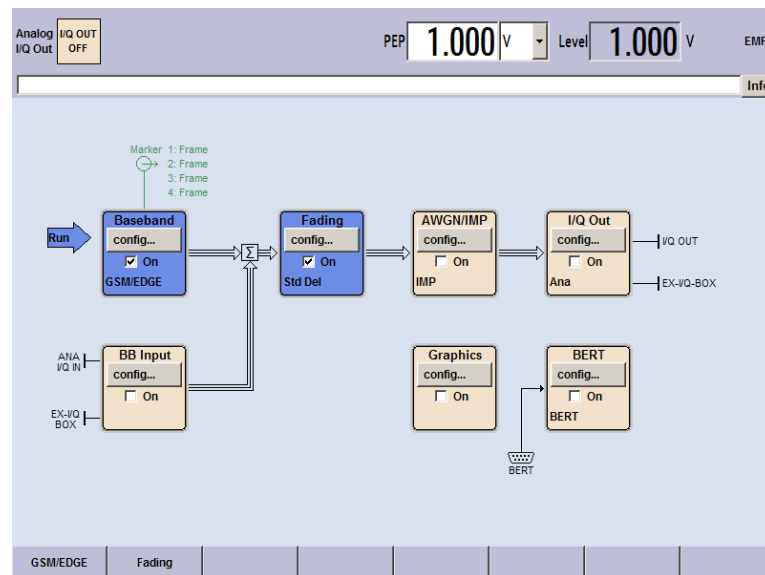

To indicate the active state, the "Fading" block is displayed in blue and the check box "On" is ticked. The "I/Q OUT" block is not yet active. The entry in the "Winbar" indicates that the "Fading" dialog is still open in the background. The dialog can be displayed in the foreground by clicking on the softkey "Fading" in the "Winbar" or by pressing the KEY below the "Fading" softkey. Press the HIDE key to minimize the dialog again.

4. Select and activate the I/Q signal output.
  - a) Turn the rotary knob to select the "I/Q Out" block.

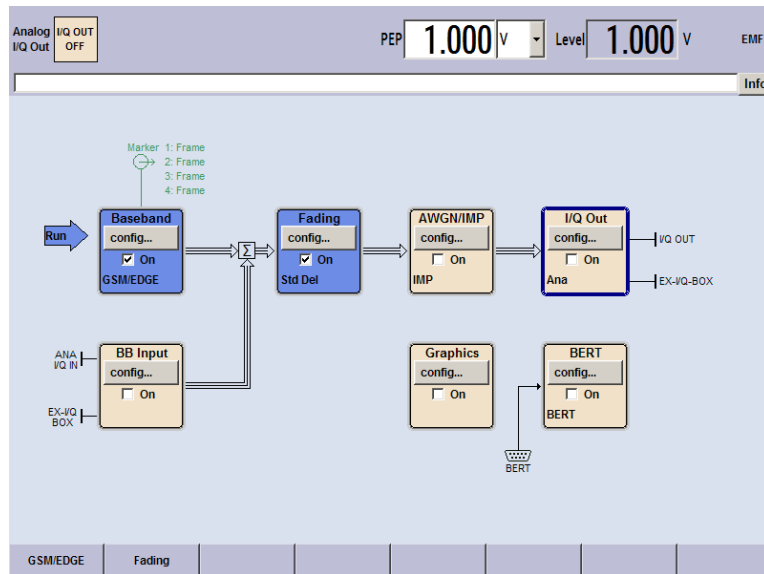

- b) Press the "config..." button to open the "I/Q Out Settings" menu.

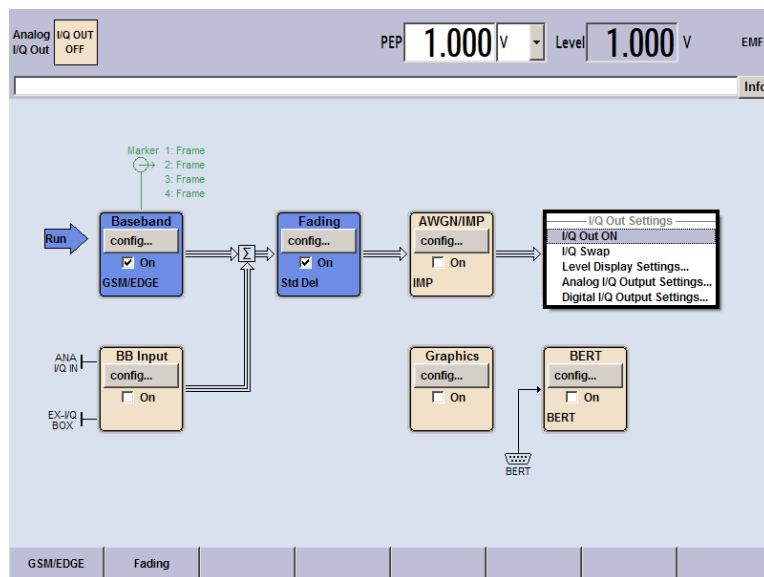

- c) Turn the rotary knob and select "Analog I/Q Output Settings".

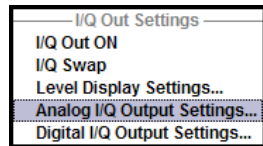

d) Press the rotary knob to open the respective dialog.

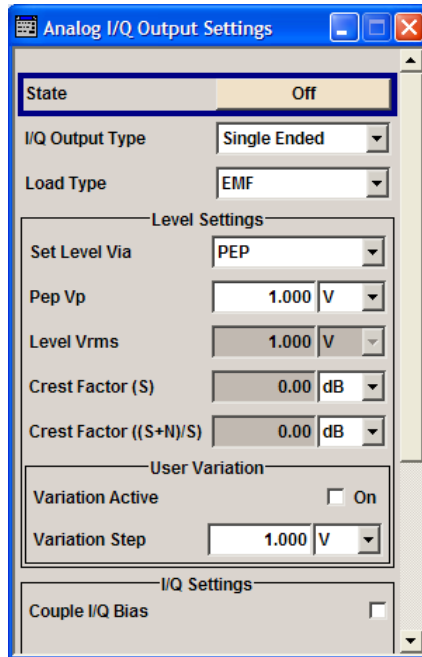

e) Switch on the analog I/Q output signal.

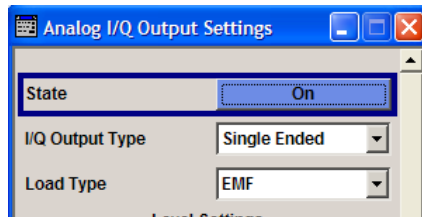

f) Press the DIAGRAM key to display the complete block diagram.

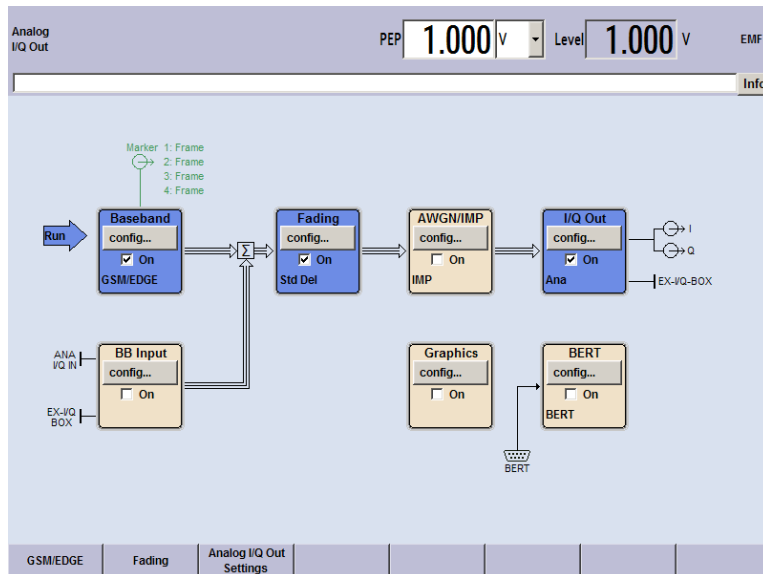

To indicate the active state, the "I/Q Out block" is displayed in blue and the check box "On" is ticked. The currently used outputs of the signal are indicated by the output symbols of the I and Q components. The entry in the Winbar indicates that the Analog I/Q Out Settings menu is still open in the background. The menu can be displayed in the foreground by clicking on the softkey "Analog I/Q Out Settings" in the Winbar or by pressing the KEY below the Analog I/Q Out Settings softkey. Press the HIDE key to minimize the menu again.

5. Select graphics display of I/Q signal.
  - a) Turn the rotary knob to select the "Graphics" block and open the respective menu.

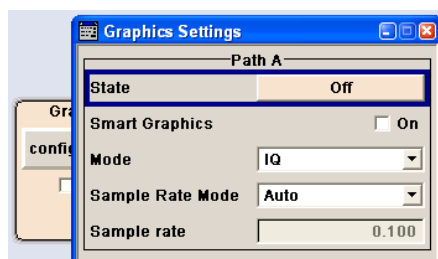

- b) Select "State On" with the rotary knob to activate display of the I/Q diagram. The output signal is graphically displayed. It can be minimized and called the same way as dialogs.

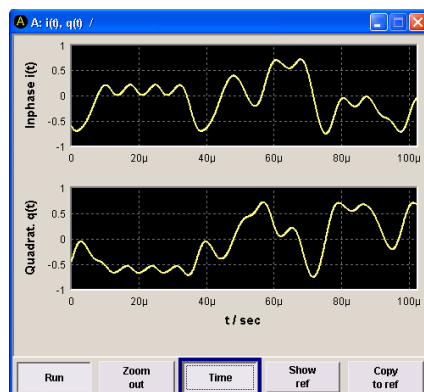



## 4 Manual Operation

The R&S AMU can be operated intuitively either via the interactive block diagram or via a menu tree. All menus are in the form of windows that can be operated in the same way. Rotary knob, keys and softkeys, or alternatively a mouse, allow direct and therefore convenient access to entries and settings.

The clear-cut display shows the current signal generator state. Graphs, spectra, vector diagrams, etc. can be called for a visual check of the output signal. Numerous help functions support the user in signal configuration.

This section describes the concept of manual operation of the signal generator. This includes a description of the general structure of a dialog box, working with dialog boxes and the block diagram and the setting of parameters.

For an in-depth description of the dialog boxes and the instrument functions refer to section "Instrument Functions".

### 4.1 Key Features

The manual operating concept of the R&S AMU enables the user to make settings as intuitively as possible and at the same time gives a permanent overview of characteristics of the generated signal and of the current instrument state. Numerous online help functions support user settings.

#### Block diagram

The block diagram is the core of the operating concept.

A graphics display shows the current configuration and the signal flow in the form of a block diagram. All graphical elements can be accessed for operation. An element is selected by means of the arrow keys and the associated setting function is called by pressing Enter. Required menus and graphs are displayed on the block diagram which is displayed again in the foreground whenever the DIAGRAM (CTRL+D) key is pressed.

#### Permanent level display

The main characteristics of the baseband signal, PEP and level, are permanently displayed in the header section of the screen (status bar) and can be directly set in the display fields by multiple pressing the BASEBD LEVEL key (CTRL+R). Changing one of the values effects that the according value will be adjusted proportionally. Additionally, auxiliary information on the parameters insertion loss or crest factor are displayed for the corresponding paths.

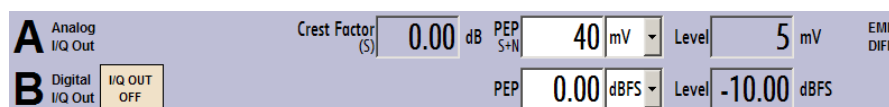

## Operation via Graphical User Interface

- **Functional blocks**

Menus are assigned to the specific function blocks in the block diagram. The function blocks represent elements of signal generation. Function blocks displayed with a blue frame can be directly switched on and off by means of the TOGGLE ON/OFF (CTRL+T) key. The menus of the highlighted function blocks can be called by pressing the ENTER key.

- **Example:**

The "Baseband" block contains all menus required for baseband signal configuration.



In this block all digital standards and the digital modulation can be selected.

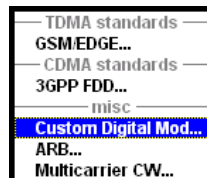

- **Signal flow**

The signal flow between the function blocks and the employed inputs and outputs are also shown.

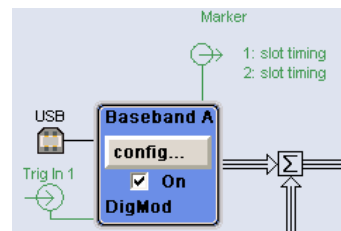

- **Menu tree**

The menu tree can be opened and closed with the MENU (CTRL+M) key. The menu tree is organized in the same way as the directories under Windows. The function blocks correspond to the first directory level, the menus to subdirectories.



## Operation corresponds to the Windows concept

To offer the user a familiar environment, operation is very similar to operation of Windows user interfaces. All menus and tables are made up of known elements, such as selection lists, check boxes and entry fields.

A blue frame indicates that the selected item is active. In the highlighted element, entries can be made.



### Rotary knob



Operation is possible via front-panel keys, an external keyboard and the mouse. However, most of the settings can be easily made with the rotary knob:

- Turning the rotary knob shifts the entry focus to the target element.
- Pressing the rotary knob activates the selected entry field. Depending on the parameter, the submenu is called, the numeric value varied, the list entry selected or the check box activated or deactivated.
- If a value is entered, the entry is stored by another click on the rotary knob and the editing mode is exited.

### Clear settings with the aid of independent subdialogs

A separate window is opened for each dialog and subdialog. The dialogs can be operated independently of each other, i.e. none of the dialogs requires that settings in other dialogs be completed before it can be closed. This ensures flexible operation at all times.

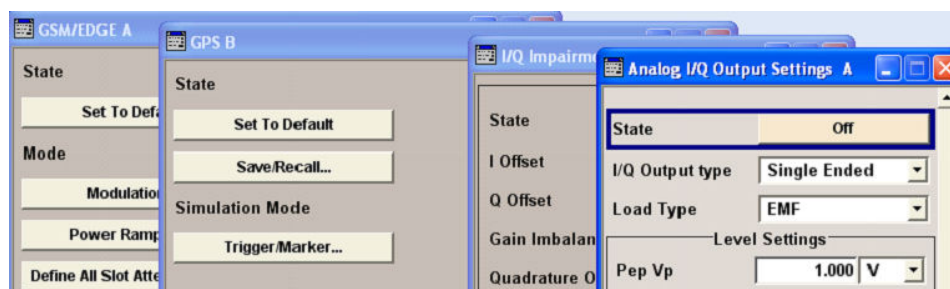

### Winbar

The Winbar gives an overview of menus and simplifies their access.

The menus are displayed on top of the block diagram but they can be "hidden" with the aid of the HIDE (CTRL+H) key, i.e. displayed in the form of a button in the "Winbar" at the lower end of the screen.

They can be displayed again in full size by a keystroke (REARR (CTRL+A) key). This makes room on the screen for other displays that may be required but the setting menus can be still accessed any time.

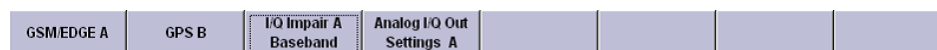

### Keys with assigned simple functions

Most keys on the front panel of the R&S AMU directly perform a simple function.

Since a great number of settings can thus be made by a keystroke, operation is easy. For instance, the CLOSE (ESC) key closes the active menu; with the BASEBD ON/OFF (CTRL+R) key the baseband output signal can be switched on or off

An exception are keys that call a menu such as the MENU (CTRL+M) key which opens the complete menu tree of the instrument, the SETUP (CTRL+E) key which opens the

menus for general instrument settings or the FILE (CTRL+S) key which opens the menu for file management.

**Help functions for user support**

Numerous help functions support the user in signal configuration.

- **Value ranges**

The valid setting range is displayed for each numeric parameter. This requires a short wait after activation of the entry field. The range is then displayed automatically after a few seconds.

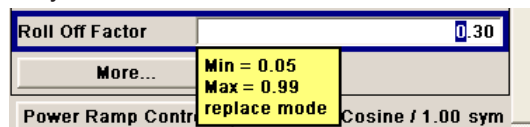

If the entered value is outside the permissible range, the next permissible value is automatically set and a message is output.

- **Context-sensitive help**

Context-sensitive help for each parameter can be called with the HELP or F1 key.

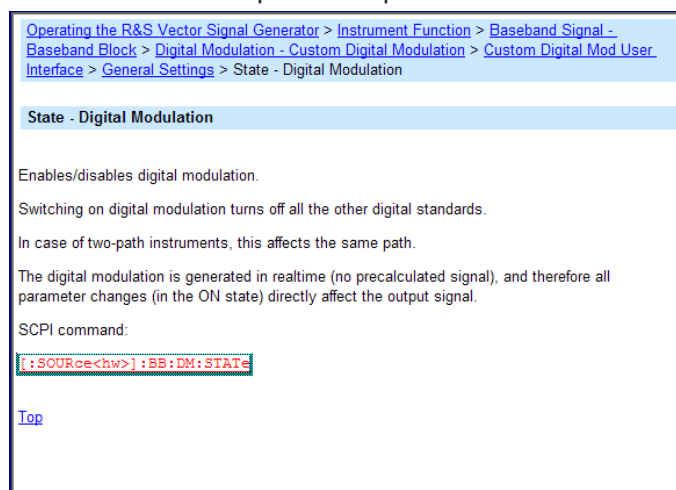

- **Comprehensive online help**

Each help page is part of a comprehensive online help function which can be called by means of an index, a content tree or the "Previous/Next" buttons.

**Info line with messages for indication of the current instrument state**

A great variety of different messages such as status messages, error messages, warnings or information are displayed in the header field of the screen. With the aid of the INFO (CTRL+I) key, help pages can be called for most of the messages. They provide background information on the message and indicate operating steps that may be required. All messages are explained in the online help which can be called with the HELP (F1) key.

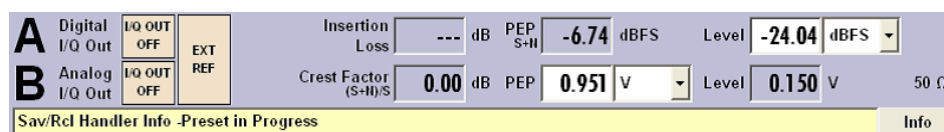

### Graphical display of data structure

The structure of the baseband signal is graphically displayed in the respective menus; the individual signal elements can be graphically selected for processing.

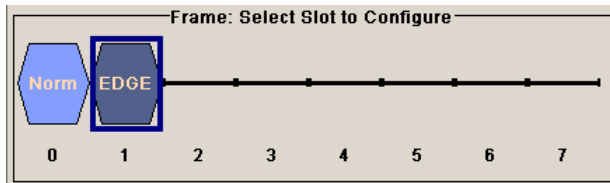

### Graphics editor for definition of control signals

Control signals are also graphically configured.

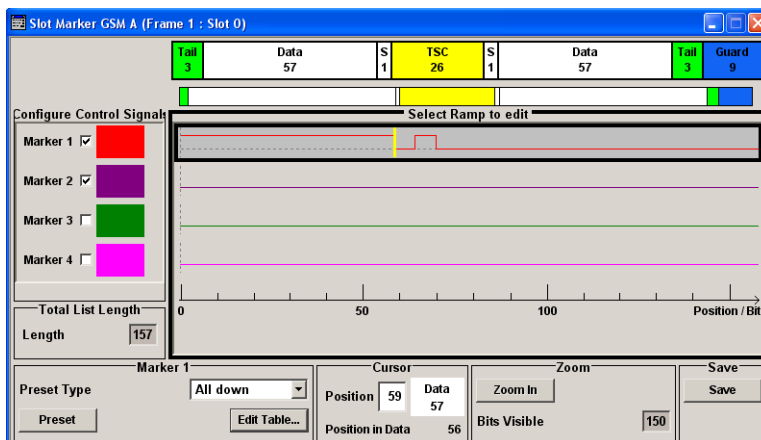

### Graphical display of output signal in a diagram

The output signal can be graphically displayed in a number of diagrams. This allows a fast check of signal characteristics. Zoom functions and the insertion of a reference trace permit in-depth evaluation without an external analyzer being required.

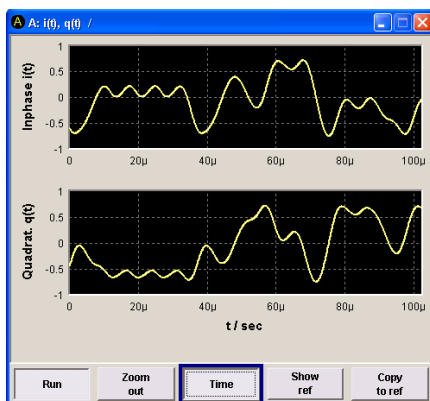

## 4.2 Display

The display shows the current signal generator state and offers graphical elements for direct operation. It is divided into three sections:

- The frequency and level display with info line indicates the main output signal parameters and reports the current state with status, error and warning messages.
- The block diagram shows the instrument configuration, the signal characteristic as well as the inputs and outputs used and permits interactive operation via graphics elements. Active menus and graphs are displayed on top of the block diagram.
- Winbar with labeled softkeys for menu display.

The block diagram in the figure below shows a fully equipped instrument.

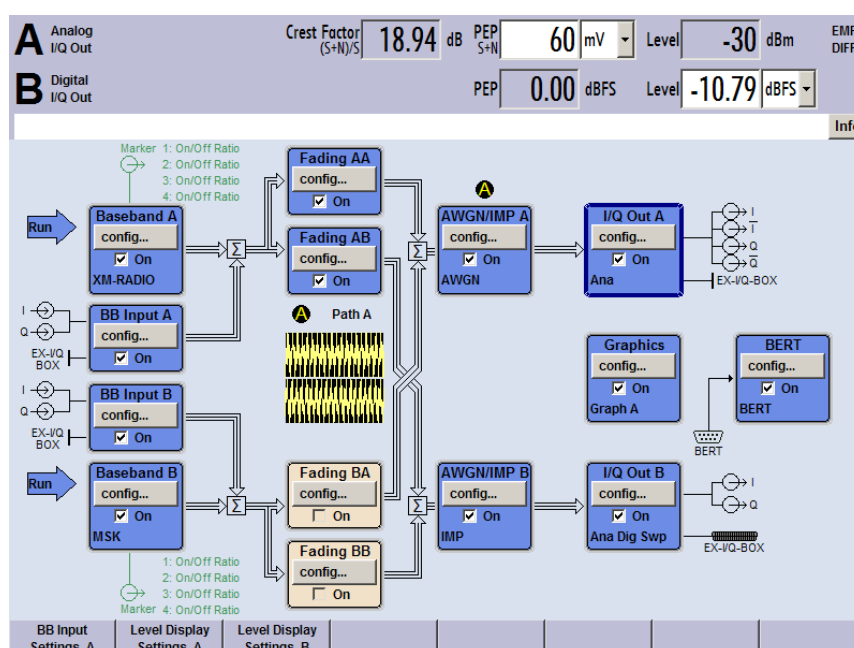

Figure 4-1: Block diagram of a fully equipped R&S AMU

### 4.2.1 Settings Displayed in the Header Section

Level settings and a few status messages (see [Chapter 4.2.2, "Status Information and Messages"](#), on page 101) are displayed in the header field of the screen. The display may vary depending on the instrument's operating mode:

- In case of two-path instruments, the baseband signal information on the two paths is displayed separately for each path.
- **PEP** indicates the peak envelope power and **Level** indicates the output voltage at the I/Q output.
- Additionally, auxiliary information on the parameters insertion loss or crest factor of the I/Q output signal is displayed.

## 4.2.2 Status Information and Messages

The instrument indicates status information and messages in the header section of the screen. The messages differ with respect to their importance (errors, warnings, info) and the time of their appearance (brief and permanent messages), and require different treatment

For additional information refer to the info window (see [Chapter 4.2.3, "Info Window"](#), on page 102).

Refer to [Chapter 9, "Status Information, Error Messages and Troubleshooting"](#), on page 675 for an overview of all status information and messages and corrective actions.

### 4.2.2.1 Status Information

The status information gives the user an overview of the main operating states and settings of the instrument. The states are indicated for information only and do not necessitate any action by the user.

Status information is displayed between the information on the current mode of the baseband output signal and the level fields, at the left of the info line or in the info line itself.

On two-path instruments, all states that can occur independently in the two paths are displayed separately for each path. The associated path is indicated in the info line.

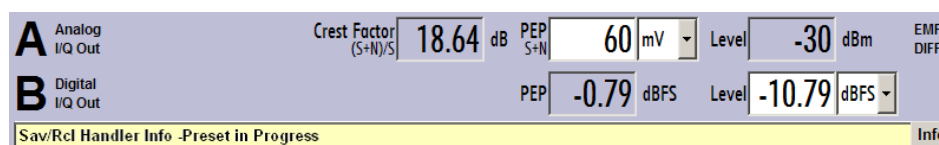

### 4.2.2.2 Messages

Messages indicate errors in the instrument. They are displayed in the info line in different colors depending on their importance and display duration. Errors (e.g. no calibration data) are displayed in red, information (e.g. file not found) and warnings in black. Warnings indicate less significant errors (e.g. the instrument operates outside specified data).

### 4.2.2.3 Volatile messages

Brief messages report automatic settings in the instrument (e.g. switching off of incompatible types of modulation) or on illegal entries that are not accepted by the instrument (e.g. range violations). They are displayed in the info line on a yellow background. They are displayed on top of status information or permanent messages.

Volatile messages do not normally demand user actions and disappear automatically after a brief period of time. They are stored in the history, however.

These messages can be read from remote using the commands `:SYSTEM:ERROR[:NEXT]?` and `:SYSTEM:ERROR:ALL?`.

#### 4.2.2.4 Permanent Messages

Permanent messages are displayed if an error occurs that impairs further instrument operation, e.g. a hardware fault. The error signalled by a permanent message must be eliminated before correct instrument operation can be ensured.

The message is displayed until the error is eliminated. It covers the status display in the info line. After error elimination, the message automatically disappears and is also recorded in the history.

These messages can be read from remote using the command `:SYSTEM:SERROR?`.

### 4.2.3 Info Window

A few operating states and the current message are displayed in the info line.

The INFO window with a list of current permanent messages and a detailed description of each message can be opened with the INFO (CTRL+I) key.

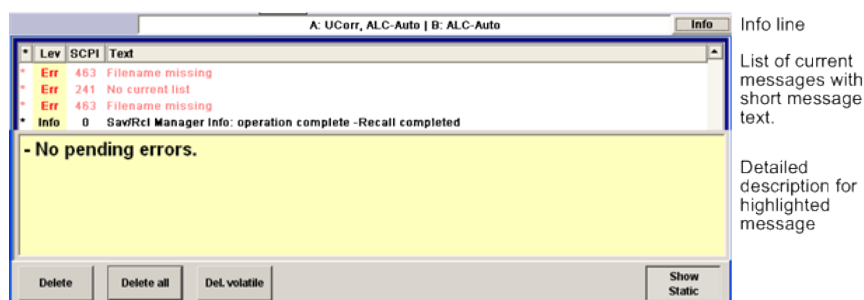

The upper section of the info window contains a list of all current permanent messages in the order of their occurrence, i.e. the most recent message is displayed first. In the lower section of the window, additional information on the highlighted message is displayed. A history of all messages that have occurred since instrument switch-on can be called with the "History" key. The most recent message is displayed first.

The messages are color-coded according to their level. Device-specific messages are red, info and remote control error are black. The level is also indicated in the "Lev" column (Err, Sys or Info). Column "SCPI" indicates the SCPI error code.

With the aid of the softkey buttons, error messages can be cleared and a history of all messages called.

#### Delete

Clears the highlighted message.

This button is available only if the history of the messages is displayed.

#### Delete All

Clears all messages.

This button is available only if the history of the messages is displayed.

#### Del. volatile

Clears all volatile messages.

This button is available only if the history of the messages is displayed.

Remote command:

:SYSTem:ERRor:ALL? on page 661

Each time a SYST:ERR:ALL? query is sent, the error queue is returned and at the same time cleared.

#### History

Calls the list of all messages that have occurred since instrument switch-on. The most recent messages are displayed at the top of the list. When the button is pressed again, the list of current messages is displayed.

Remote command:

:SYSTem:ERRor[:NEXT]? on page 662 or :STATus:QUEue[:NEXT]? on page 660

Each time a SYST:ERR? or STAT:QUE? query is sent, the oldest entry in the error queue is returned and at the same time cleared in the list.

## 4.2.4 Block Diagram

The block diagram shows provided options, signal configuration and the currently selected signal flow of the generator with inputs and outputs used. Signal generation can be completely operated from the block diagram. The highlighted function block can be directly switched on and off with the TOGGLE ON/OFF (CTRL+T) key. Pressing the Enter opens the associated setting menu.

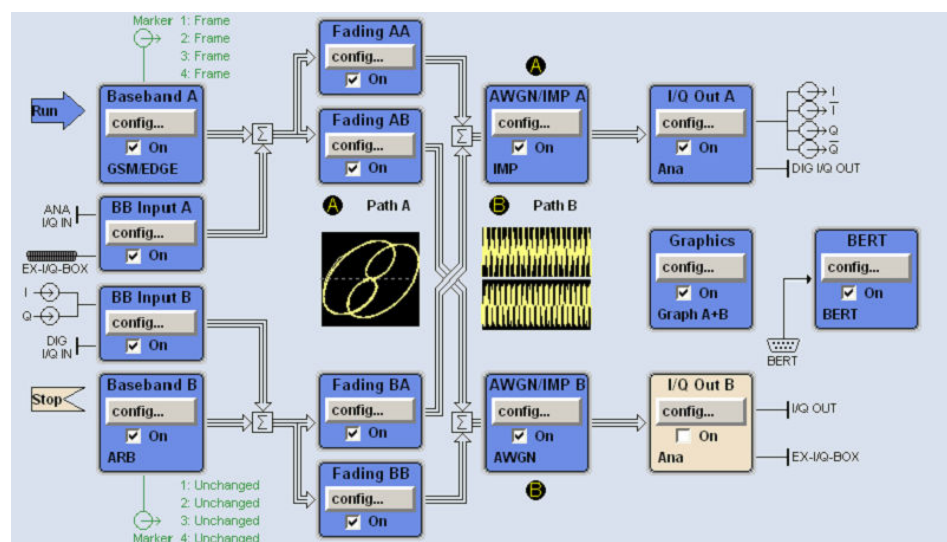

Figure 4-2: Block diagram of the R&S AMU

#### 4.2.4.1 Function Blocks in the Block Diagram

Each block represents a function of signal generation. The function is indicated in the headline of the block. In the check box, the respective function can be quickly activated/ deactivated with the TOGGLE ON/OFF (CTRL+T) key. After activation, the block is displayed in blue. Status information is displayed below the check box. It is different for the different blocks.

Pressing the rotary knob (front panel) or the "Config..." button (mouse) opens the associated setting menu.

In all function blocks where the signal flow can be influenced, the top menu level for setting signal routing parameters is offered.

##### Example: Baseband block

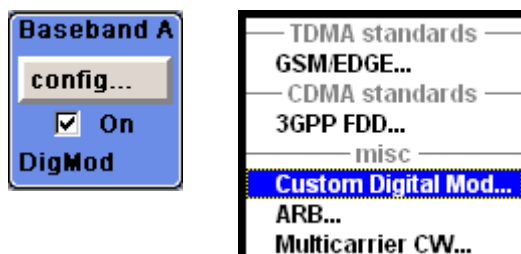

In this block, the digital modulation signal, the digital standards, arbitrary waveform generation and multicarrier CW are set. The status information of the "Baseband" block indicates the selected modulation and associated additional information, e.g. the number of channels.

#### 4.2.4.2 Signal Flow and Input/Output Symbols in the Block Diagram

The input/output symbols in the block diagram show the currently used inputs and outputs of the signal generator. Unused inputs and outputs are not shown. The lines indicate the signal flow.

Symbols and labels refer to the corresponding inputs and outputs on the front and rear panel of the signal generator. The direction - input or output - is indicated by an arrow.

##### Example:

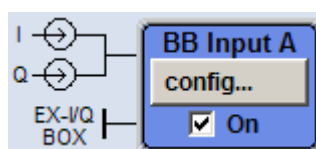

The symbols indicate the inputs for the analog I and Q signal on the instrument front panel.

If several markers are active, the marker characteristics are listed next to the marker symbol of the active markers.

Symbols and lines are displayed in different colors depending on their function.



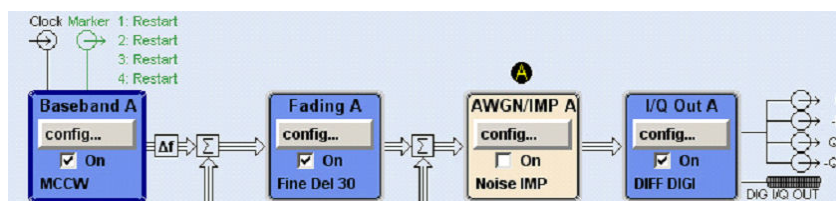

- The baseband signal is indicated by a three line arrow, the I- and Q-components of the signal by a single-line arrow.
- Addition of signals is indicated by the summation sign.
- Connections are indicated by a "solder point".
- Black is used for the generated signal.
- Green is used for control signals.

The signal flow is configured in the individual menus. User interfaces are configured in:

- the "Setup > USER Marker /AUX I/O Settings" dialog and
- the "Setup > Global Trigger/Clock/External Inputs" dialog.

#### 4.2.5 Winbar and Softkeys

The "Winbar" is displayed below the block diagram. Labelled buttons represent open menus, the label indicates the menu. If several menus are open, the button of the currently active menu is displayed in a lighter colour. The buttons also assign functions to the softkeys of the next lower level for front-panel operation. Up to eight menus may be open simultaneously. When the ninth menu is opened, the menu that was opened first is automatically closed.

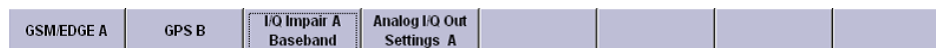

Some menus, e.g. data and list editor menus, cover the "Winbar" and assign menu-specific functions to the front-panel softkeys by way of the menu buttons.

Any of the open menu can be activated either with the respective button in the "Winbar" or the front-panel softkey. In combination with the keys for menu operation (CLOSE (ESC), HIDE (CTRL+H) and REARR (CTRL+A)), convenient menu operation can be ensured.

Working with menus and dialog boxes is described in [Chapter 4.3, "Accessing Dialogs"](#), on page 107.

#### 4.2.6 Structure of the Dialogs

The parameters are set in the menus. Menus are accessed either via the function blocks in the diagram or by means of the MENU (CTRL+M) key. The menus are displayed on top of the block diagram.

If the menu buttons assign menu-specific functions to the softkeys, the "Winbar" is hidden.

Working with menus and dialog boxes is described in [Chapter 4.3, "Accessing Dialogs"](#), on page 107; the setting of parameters in [Chapter 4.4, "Setting Parameters"](#), on page 108.

The menus are in Windows format. The menus differ in details depending on their function but they consist of the same main elements. Each menu consists of a menu header and one or more menu areas with various fields for setting parameters.

The header line contains the name of the menu and the buttons for minimizing and closing the menu. To operate the buttons, use the mouse or the front keys HIDE (CTRL+H) and CLOSE (ESC).

Several fields of associated but separately set parameters are organized in menu areas. A menu area is framed and labelled with the function common to all parameters.

#### Example: Impairments

Each of the setting fields is assigned a parameter name. The kind of setting varies depending on the parameter to be set. Some settings can only be made in a specific configuration. If setting is not permitted with the specific configuration selected, the respective item is disabled and displayed in gray and the entry or selection field cannot be accessed.

## 4.2.7 Graphical Display of Output Signal Characteristics

The graphical display of the output signal enables the user to rapidly check signal characteristics without connecting an analyzer. Zoom functions and the display of a reference trace allow in-depth evaluation. The diagram is displayed on top of the block diagram. It can be minimized and called in the same way as a menu.

#### Example: I/Q diagram

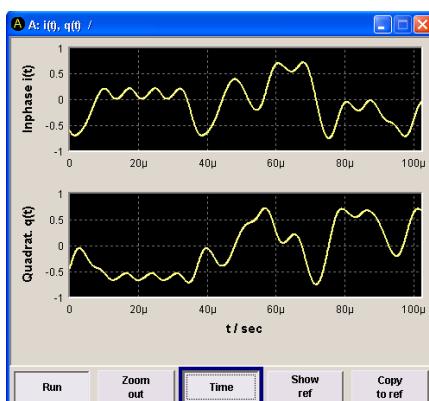

To access the "Graphics Settings" dialog for selecting the graphics display of the output signal, select the "Graphics" function block in the diagram or press the MENU (CTRL+M) key.

Operation of the graphics windows is analogous to menu operation.

The menu and the individual graphical displays are described in [Chapter 5.3, "Graphical Display - Graphics"](#), on page 177.

## 4.3 Accessing Dialogs

The MENU (CTRL+M) key opens the complete menu tree. Selecting a functional block and pressing the ENTER key opens the menu associated with this block.

An alternatively way to access a dialog is to use the Winbar buttons or front-panel softkeys or to use the HIDE (CTRL+H), CLOSE (ESC), DIAGRAM (CTRL+D) and REARR (CTRL+A) keys on the front panel.

For a quick access to the dialogs, use one of the following alternative methods.

### Displaying the block diagram or a dialog in the foreground

1. Press the DIAGRAM (CTRL+D) key to move the cursor to the block diagram.  
All active menus are minimized and displayed in the form of Winbar buttons.
2. Press the associated softkey (CTRL+F1 .. F8) to display the dialog in the foreground again.

### Accessing the menu tree

- ▶ Press the MENU (CTRL+M) key to open the complete menu tree.

### Calling the File, Setup or Hardcopy dialogs

- ▶ Use the FILE (CTRL+S), SETUP (CTRL+E) or HCOPIE (CTRL+Y) keys to open the respective dialog.

### Minimizing an active menu

- ▶ Use the HIDE (CTRL+H) key to minimize an active menu.  
It is displayed in the form of a Winbar button.

### Automatically arranging displayed menus

- ▶ Press the REARR (CTRL+A) key to rearrange all open menus so that they overlap as little as possible.

### Activating the Winbar

- ▶ Use the WINBAR (CTRL+W) key to toggle the cursor between a button of the "Winbar" and the block diagram.

The button that was active last in the Winbar is highlighted.

### Closing an active menu

- ▶ Press the CLOSE key to close an active menu.

**Tip:** If the cursor is at the highest menu level, you can also use the ESC key to close the active menu.

### Accessing the header area

- ▶ Press the BASEBD LEVEL (CTRL+R) key to activate the "PEP" or "Level" entry fields in the header area. Press the BASEBD LEVEL (CTRL+R) key again to switch between the active input fields.



### Keyboard Shortcuts

Keyboard shortcuts (e.g. "Ctrl + D" for the displaying the block diagram in the foreground) provide direct access to all utility dialogs of the instrument (see [Chapter 4.8, "Legend of Front-Panel Controls"](#), on page 129).

## 4.4 Setting Parameters

The R&S AMU offers several and sometimes alternative possibilities for setting parameters. Operation is possible from the front panel, with the aid of a mouse and/or from a PC keyboard.



The examples within this description focus on the operation from the front panel.



For more information, refer to:

- [Chapter 4.8, "Legend of Front-Panel Controls"](#), on page 129 for an overview of key functions and a cross-reference between the front panel keys and the keyboard shortcuts
- section "Instrument Functions" for a detailed description of key functions.

Most of the parameters are set in the different menus. The R&S AMU provides alternative ways for accessing the dialogs. Turn the rotary knob and navigate to the corresponding block in the block diagram and press the knob to open the dialog or perform a mouse click on the "Config..." button.

An exception are the "Setup", "File" and "Hcopy" dialogs. In the "Setup" dialog, general settings are made which are not directly concerned with signal generation, e.g. setting

of the GPIB-bus address. In the "File" dialog, files and lists are managed; in the "Hcopy" dialog, printout is configured and hardcopies can be made. These menus can only be called with the SETUP (CTRL+E), FILE (CTRL+S) and HCOPY (CTRL+Y) keys.

Level parameters are directly set in the header area of the display using the BASEBD LEVEL key. Some of the keys trigger a direct action, e.g. the BASEBD ON/OFF key switches the baseband output on and off. Changes affecting the signal flow are immediately visible in the graphics display.

The R&S AMU uses the Windows Embedded Standard operating system. Settings at system level are only rarely required, for example installation of a new printer driver. For convenient operation, a keyboard and a mouse are required.

This section provides an information about the parameter handling that comprises of the following main steps:

- [Chapter 4.4.1, "Working with the Cursor"](#), on page 109
- [Chapter 4.4.2, "Selecting a Control Element"](#), on page 110
- [Chapter 4.4.3, "Switching Parameters On/Off"](#), on page 110
- [Chapter 4.4.4, "Entering a Value"](#), on page 110
- [Chapter 4.4.5, "Working with Units "](#), on page 112
- [Chapter 4.4.6, "Selecting a Value from a List"](#), on page 113
- [Chapter 4.4.7, "Terminating Entries with Confirmation"](#), on page 113
- [Chapter 4.4.8, "Restoring the Previous Value"](#), on page 114

#### 4.4.1 Working with the Cursor

After the instrument is switched on, the cursor is always on the first function block of the diagram (default setting).

##### Moving the cursor on the display

► To move the cursor, use one of the following alternative methods:

- a) Use the rotary knob or the arrow keys.
- b) Use the appropriate softkeys (CTRL+F1..F8) to move the cursor to the "Winbar".  
If the "Winbar" is covered by a menu, press the WINBAR (CTRL+W) key to display it in the foreground.
- c) Use the ESC key.

**Tip:** Be aware that the function of the ESC key depends on the current cursor position.

The function of this key depends on the current cursor position.

- Calls the next higher selection level.
- Closes the open window without accepting new entries; the old value or parameter is retained.
- In dialog boxes that contain a "Cancel" button it activates that button.
- Closes all kinds of dialog boxes, if the edit mode is not active.
- Quits the edit mode, if the edit mode is active.

- Switches between different entry fields of a menu.
- Shifts the entry cursor from the header display to the previously active menu, or to the previously highlighted block in the block diagram if no menu is active.
- Shifts the cursor from a function block in the diagram to the first item in the "Winbar". If no menus are open, the current cursor position remains unchanged.

#### Moving the cursor to the heading area

- ▶ Press the BASEBD LEVEL (CTRL+R) key to activate the "PEP" or "Level" entry fields in the header area. Press the BASEBD LEVEL (CTRL+R) key again to switch between the active input fields.

### 4.4.2 Selecting a Control Element

Control elements are always selected in the same way no matter whether a function block in the diagram, a menu in the menu tree, a parameter in the menu or an entry in a list or table is concerned.

- ▶ To activate an element, put the cursor on it.



An active element is highlighted by a blue frame.

### 4.4.3 Switching Parameters On/Off

A parameter can be activated and deactivated using a button or a check box.

1. Select the parameter.
2. To change the state of a parameter, use the "Enter" function of the different control media:
  - Press the rotary knob
  - Press ENTER
  - Press the TOGGLE ON OFF (CTRL+T) key.

Colour and label of a button change, the check box is ticked or the tick is removed.

### 4.4.4 Entering a Value

Numeric and alphanumeric values can be edited in the entry fields. In the editing mode, cursors of different colour are used. A blue cursor indicates the overwrite mode, a green cursor the insert mode.



### Changing between the Insert and Overwrite mode

The insert mode is the default setting.

Use the INSERT key to toggle between the insert and overwrite mode.

Numeric and alphanumeric values can either be newly entered or the existing value can be changed. Incorrect entries are cleared with the BACKSPACE key.

### Entering a new numerical value

1. Select the parameter.
2. Press a numeric key to activate the editing mode.

The previous value is cleared and the new value can be entered.

### Editing a value in the insert mode (default setting)

1. Press the rotary knob (= Enter) to activate the editing mode.  
If the cursor is placed at the right of the total value, the insert mode is always active.
2. Set the cursor to the left of the number to be changed using the LEFT/RIGHT arrow keys.  
The cursor is displayed in green.
3. Click on a numeric key to insert a new value.



### Editing a value in the overwrite mode

1. Activate the editing mode.
2. Set the cursor on the numeric digit to be changed using the LEFT/RIGHT arrow keys.  
The cursor is displayed in blue and the number to be replaced is highlighted.
3. Click on a numeric key to overwrite the highlighted value.



### Varying a value

1. Activate the editing mode.
2. Set the cursor to the left of the number to be changed using the LEFT/RIGHT arrow keys.  
The value at the cursor position is varied.

- To vary the selected value, use the UP/DOWN arrow key or turn the rotary knob.  
The value is increased or decreased.

### Entering a new alphanumerical value

- Select the parameter.
- Press an alphanumeric key to start the editing mode.  
The new value is entered.

### Editing an alphanumerical value

An existing value, e.g. a file name, can be changed in the insert mode (see example) or in the overwrite mode.

- Select the parameter and activate the editing mode.
- Set the cursor to the left of the alphanumerical value using the LEFT/RIGHT arrow keys.  
**Tip:** If hexadecimal values are to be entered, the numeric front-panel keys are automatically changed to hexadecimal values.
- Click on an alphanumeric key to insert a new alphanumerical value.



### Terminating the entry of a numeric value

To terminate the entry of a numeric value:

- Press the rotary knob (= Enter).
- Press a UNIT key on the front panel.
- Select a "Unit" in the selection field next to the parameter value.

## 4.4.5 Working with Units

The unit of a parameter is displayed next to the value. When the parameter is edited, the unit is selected either from the list or by means of the front-panel keys. When the entry is completed, the unit can be changed. In this case the value remains unchanged but is automatically adapted to the new unit.



While operating the instrument by means of a mouse, assign the unit to the selected parameter before entering its value.

### Assigning a unit

To assign a unit to a value, use one of the following alternatives:

- Press a UNIT key on the front panel.





2. Select a "Unit" in the selection field next to the parameter value.  
Press the ENTER key.

The unit displayed in the entry field next to the value is assigned.

### Changing a unit

To subsequently change a unit, i.e. after the entry has been terminated and when the editing mode is not active, use one of the following alternatives:

1. Press a UNIT key on the front panel.
2. Select "Unit" in the selection field next to the parameter value.

The value remains unchanged but the display is automatically adapted to the new unit, i.e. the value is recalculated to suit the new unit.

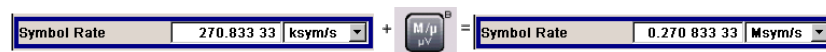

The new unit is indicated in the value field of the menu.

## 4.4.6 Selecting a Value from a List

Selection lists provide a list of predefined values for the selected parameter.

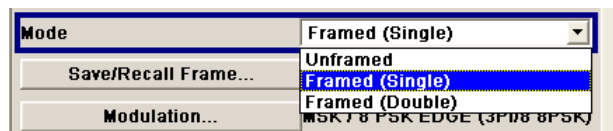

To select a item from a list, proceed as follow:

1. Press ENTER key to open the list.
2. Use one of the following alternatives to navigate through the list:
  - a) Turn the rotary knob or use the UP/DOWN arrow keys.  
The selected item is highlighted.
  - b) Press TOGGLE ON/OFF key several times until the preferred entry is displayed in the selection field.
3. To confirm the selection, press the ENTER key.

## 4.4.7 Terminating Entries with Confirmation

The instrument behaves different by the termination of entries depending on the parameter type and the way this parameter is set.

### Confirming settings

- ▶ To confirm the settings, press the rotary knob or one of the UNIT keys (see also [Chapter 4.4.5, "Working with Units"](#), on page 112).

**Note:** Variations by means of the rotary knob are immediately set.

### Confirming multiple values

In some cases, like for instance when configuring the carriers for a multicarrier CW signal in a carrier table, it is useful first to enter few values and to confirm them together. Such settings require additional confirmation. Not yet confirmed settings are displayed on a yellow background as an indication that the currently displayed values do not represent the target signal.

- ▶ To confirm these settings, select the "Accept" button.

### Confirming parameters with On/Off state

Most of the instrument functions with enabled and disabled states are calculated and effective only after this functions have been enabled. However, there are functions like the frequency variation of the reference oscillator for instance, that are immediately set after confirmation.

- ▶ To confirm a parameter with On/Off state, enable the parameter.

If time-consuming calculations are required, signal generation is automatically switched off and calculation is interrupted to allow the user to make further settings. Calculation is restarted with the RECALCULATE key and the modulation is switched on again when the calculation is completed.



### Preventing recalculation

If an instrument function requires several parameter settings, switch the function off to prevent a recalculation.

Enable the function after the entire configuration of the settings have been completed. The signal is recalculated only once.

---

## 4.4.8 Restoring the Previous Value

Parameter variations with the rotary knob are immediately set and therefore not reversible.

Normally, values cannot be restored in the case of mouse control because no explicit confirmation is required in this case and entries are automatically confirmed when the entry or selection field is exited.

### Restoring values

In the case of front-panel control or operation from the keyboard, previous values can be restored as long as the new value is not confirmed, i.e. the entry is not completed.

- ▶ To restore the values, press the ESC key.

### Restoring values that require confirmation

All settings that are not confirmed with the "Accept" button but require this additional confirmation can be restored.

1. Press the ESC key.

A confirmation query is displayed.

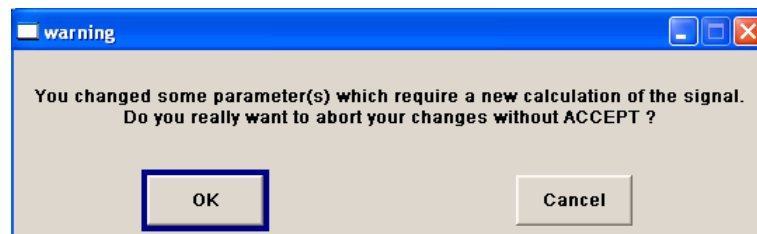

2. Confirm with "OK" to abort the changes.  
Select "Cancel" to return to the dialog. The previous selected settings are displayed.

### Restoring values after an extended calculation has been started

Calculation and setting might require different period of time. Many settings are made without noticeable calculation times; such operations are indicated by a "BUSY" message displayed in the status field of the header section.

A window with a progress indicates that the instrument performs an extended calculation that requires longer calculation time. The termination of such a calculation restores the previous values.

- ▶ Press the ABORT button to terminate the calculation.

All previous values are restored.

## 4.5 Editors

The R&S AMU provides user-friendly editors for defining data lists as well as control and marker signals.

Internally generated data lists can be used for digital modulation and digital standards; the same applies to internally defined control and marker signals.

The lists are saved to files and may thus have any length. The file name of the lists and the directory to which the files are saved are user-selectable. The file prefix is different for each list type and is permanently assigned by the system.

For information about file handling and overview of the automatically assigned file prefixes, refer to [Chapter 4.7, "File Management"](#), on page 123.

### 4.5.1 Working with Data Editor

The "Data Editor" is used to internally generate binary data lists for digital modulation and digital standards.

A list of binary values with a maximum length of  $2^{31}$  bits can be entered in the "Data Editor". This value corresponds to a file size of approx. 268 Mbyte. While it is being processed, the file is continuously automatically buffered. When the dialog is exited, the file is automatically saved with the new values, i.e. there is no extra "Save" button. Depending on the size of the file, saving may take some time.

#### Editing an existing data list

1. To **access** a data editor and open an existing data list for editing, use the arrow keys to select the associated button "Edit Data List..." in the individual menu.

The selected data list is displayed.

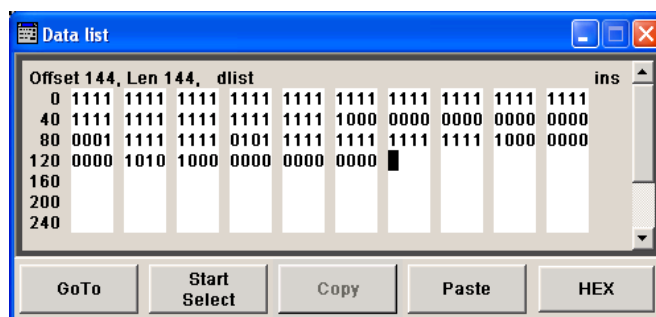

The cursor marks the start value of the list.

To increase readability, the bits are displayed in groups of four. The current cursor position, the length of the list and the list file name are displayed above the list. The offset starts with the value 0 which corresponds to the bit position on the left side of the first row, i.e. the beginning of the list. On the left edge of the editor, the last three offset positions are specified at the beginning of the row.

2. Use the numeric keys to enter the values 0 or 1.  
An existing list can be edited in the insert or overwrite mode. Use the INSERT key to toggle between these two modes.
3. To **delete** a value, use the arrow keys to mark the bit that follows the value to be deleted.  
Press the INSERT key to activate the insert mode. Values cannot be deleted in the overwrite mode.  
Press the BACKSPACE key.  
The value before the marked bit is deleted.
4. To **select a bit position**, select the "GoTo" button and press the ENTER key.  
Enter the bit position in the "GoTo Offset" entry field by means of the numeric keys and confirm the entry.  
The cursor marks the bit at the selected position.
5. To **copy and paste** any range of bits at any position in the list:

- a) Use the the arrow keys to mark the start bit of the selection.
- b) Select the "Start Select" button and use the the arrow keys to mark the selection.
- c) Click the "Copy" button.
- d) Navigate to the insert position and select "Paste".

The selected and copied bits are pasted after the selected position.

6. To **display and edit** the values in hexadecimal form, select the "Hex" button.  
Each four bits are displayed as a hexadecimal value: To increase readability, the hexadecimal values in turn are displayed in pairs of two. The hex functions are automatically assigned to the numeric keys at the front panel.
7. To **save** the data list, press the ESC key.  
The list is saved automatically when the dialog is closed.

#### Creating a new data list

1. To create an empty data list, in the individual menu select "List Management > Select Data List to Edit... > Create Data List" and enter the file name of the new data list.
2. To open the data list for editing, select the associated button "Edit Data List..." in the individual menu.

### 4.5.2 Working with Control and Marker List Editor

The control and marker signals for digital modulation and digital standards can be very conveniently graphically defined in a "Control and Marker List Editor". The available marker signals – and, with custom digital modulation, the CW, Hop, Burst Gate and Lev Att control signals – can be defined in this editor.

While it is being processed, the file is continuously automatically buffered. Depending on the size of the file, saving may take some time.



The various functions of the editor are explained in the individual menus. This section focuses to the general use of the graphic editor.

---

**Example:**

The following figure shows the "Slot Marker Definition Editor" of the "GSM/EDGE" dialog as an example.

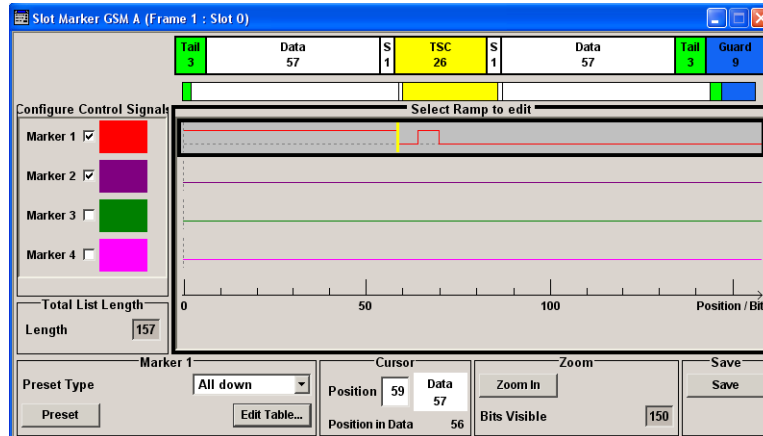

The upper area displays the signal for which the marker signals are to be defined. On the left side, the available signals (marker and control signals) are listed and colour-coded.

Auxiliary functions are offered in the lower editor area, e.g. presetting for the ramps in the marker signal, cursor positioning by entering the bit position and possible editing by means of value entries in a table.

The actual graphic definition of the control signals occurs in the center area of the editor. Each control signal is represented by means of a colored line along the bit axis. A cursor can be shifted alongside this line and marks the position where a ramp is to be set. The color of the cursor changes depending on the current function.

Use the ENTER key to switch over between the colors (and therefore functions):

- black: marks the bit position on the marker line
- yellow: sets a ramp
- green: activates the marked ramp for shifting.

**Accessing control and marker list**

1. To access the control list editor (e.g. "CList Dig Mod") and open an existing list for editing, use the arrow keys to select "Custom Digital Mod > List Management > Edit Control List".

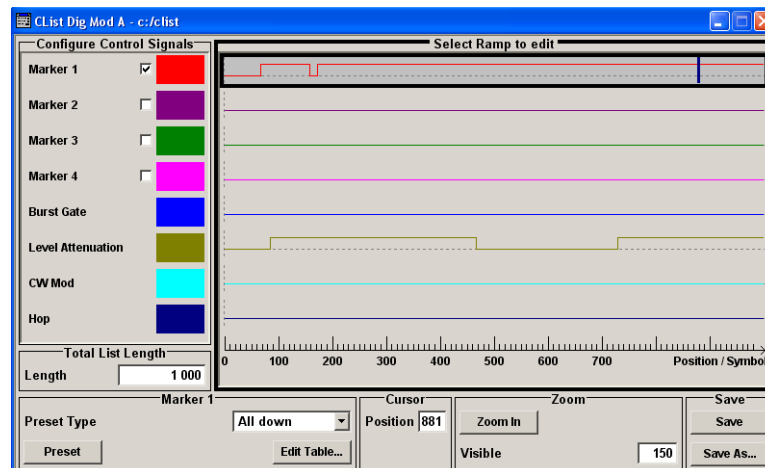

- To access the slot marker list editor (e.g. "Slot Marker") and open an existing list for editing, use the arrow keys to select "GSM/EDGE > Burst Editor > Slot Marker Definition".

### Editing an existing control or marker list

- Activate control/marker signal line for editing.  
Use the arrow keys to mark the editable graphic area and press the ENTER key. Select the control/marker signal line to be edit and press the ENTER key.  
The cursor is active for the selected line.
- Define the cursor position.  
Select the parameter "Cursor Position", specify the position by means of the numeric keys and confirm the entry.  
The cursor is positioned according to the entry. If the entered value exceeds the selected length of the definition range, the length is adjusted automatically.
- Configure the control and marker signals (see "[Handling of Ramps](#)" on page 120).
- Define length of control list ("Custom Dig Mod" only).  
Select the "Total List Length" entry field and press the ENTER key. Enter the length by means of the numeric keys and confirm the entry.  
The control list length is defined.
- Zoom displayed range ("Custom Dig Mod" only) in long control lists.  
To zoom the displayed area around the current "Cursor Position", select the parameter "Visible/Bits Visible", enter the number of symbols/bits to be displayed by means of the numeric keys and confirm the entry.  
Select the "Zoom In" button and press the ENTER key.  
The selected number of symbols/bits around the current cursor position are displayed.  
Ramps outside the displayed area are not lost by zooming.
- Use the "Save"/"Save As..." function to save the edited control/marker list under its current name or under a new name.

Enter the file name in the "Create File" dialog and select the directory (see [Chapter 4.7.1, "File Select Dialog"](#), on page 124).

### Handling of Ramps

#### 1. Set a new ramp

Use the arrow keys or use the parameter "Cursor Position" to move the cursor to the position where the ramp is to be inserted. Press the ENTER key.

The ramp transition of the newly set ramp depends on the current status (high or low) of the control signal. If the signal is low, a ramp with low-high transition is generated; if the signal is high, a ramp with high-low transition is generated.



When ramps are set between existing ramps, the transition of the new ramp is also defined by the status of the signal before the new ramp. For this reason, a ramp that has already been set can be assigned low-low or high-high transition (as in the example), i.e. it will have no effect on the control signal in this configuration. However, the ramp remains saved, and its position is indicated by a dashed line.

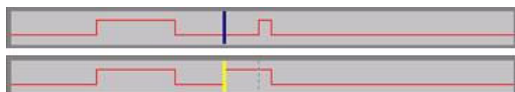

If another change produces effective transition, this ramp will be regenerated.

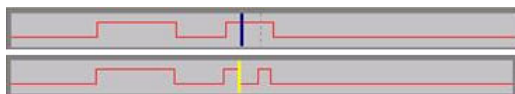

#### 2. Shift a ramp

An existing ramp can be shifted to any positions. The transitions are adjusted accordingly.

Use the arrow keys to move the cursor to the ramp position; the cursor changes colour.

Press the ENTER key. The cursor again changes colour. The ramp will now be shifted by means of the cursor. Press the ENTER key. The ramp will be set at the current position.

The ramp transition depends on the status (high or low) of the control/marker signal before the ramp.



#### 3. Delete a ramp

Use the arrow keys to move the cursor to the ramp position; the cursor changes colour.

Press the BACKSPACE key.

The ramp will be deleted. The ramp transitions of the other ramps are adapted to the changed signal status (high or low).

#### 4. Set the ramps in a table



Select the "Edit Table..." button and define the positions and states of the ramps for the selected marker.

Confirm the entries with "Accept".

5. Preset a marker signal

Select the "Preset" button to preset the marker signal.

The ramps of the selected marker are adjusted according to the selected "Preset Type".

### Creating a new control list

A new control list can be created under a new name either by generating a blank file or by changing an existing list which will then be saved under a new name.

1. To create an empty control list, select "BB > Cust Dig Mod > List Management... > Select Control List to Edit > Create Control List" and enter the file name of the new control list.
2. To open the control list for editing, select the associated button "BB > Cust Dig Mod > List Management... > Select Control List to Edit > Edit Control List..." and select an existing control list.

## 4.6 How to Use the Help System

The R&S AMU is equipped with a context-sensitive help function. A help page is available for each parameter and can be called any time during instrument operation.

### Calling context-sensitive and general help

- To display the general help dialog box, press the HELP (F1) key.

The help dialog is displayed. A topic containing information about the current menu or the currently opened dialog box and its function is displayed.

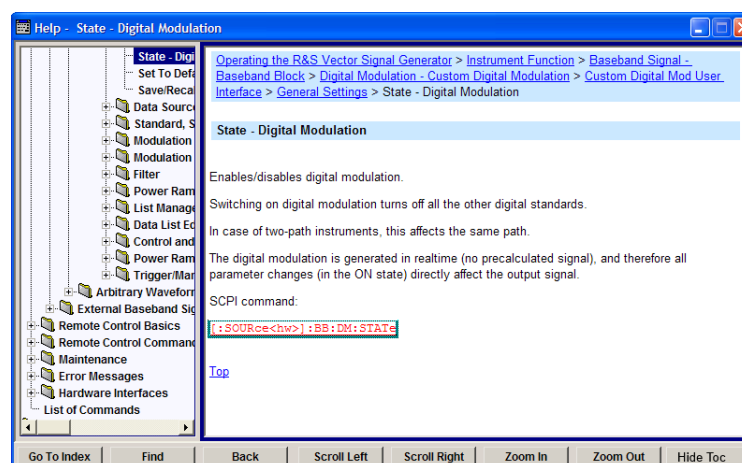

### Contents of the help dialog box

The help dialog box contains two main areas:

- "Contents" - contains a table of help contents
- "Topic" - contains a specific help topic

The help system provides additionally an "Index" and a "Find" area, as well as "Zoom" functions that are accessed by means of the corresponding buttons.

### Navigating in the table of contents

1. To navigate within the table of contents entries, use the UP/DOWN keys. Entries that contain further entries are marked with a plus sign.
2. To display a help topic, press the "ENTER" key.  
The corresponding help topic is displayed.

### Navigating in the help topics

1. To scroll through a page, use the UP/DOWN arrow keys.
2. To follow a cross-reference, select the link text.
3. To return to the previous page, select "Back".  
This function scrolls back all steps that you have performed before.
4. Use the "Scroll Right" or "Scroll Left" buttons to shift the indicated area of the navigation window to the left or right.
5. To maximize the "Topics" window, you can hide the contents tree with the "Hide Contents" button, and vice versa.

### Using the Index

1. Select the "Go to Index" button.
2. Enter the first characters of the topic you are interested in. The entries starting with these characters are displayed.
3. Press the ENTER key to change the focus.
4. Use the UP/DOWN keys to navigate and select the suitable keyword.
5. Press the ENTER key to display the help topic.  
The corresponding help topic is displayed.

### Closing the help window

- ▶ Press the HELP (F1) key.

## 4.7 File Management

The R&S AMU uses files to save all instrument data, i.e. system and user data.

The user data includes saved instrument settings, data for the different digital standards as well as the waveforms for the arbitrary waveform generator.

The files are stored on the hard disk of the instrument. Drive `D:\` can be used to save user-defined data; any directory structure can be created on `D:\`. Some default directories are predefined, but can be changed at any time. The `C:\` drive is a protected system drive. The files on this drive contain data that must not be changed. Therefore, this drive should not be accessed, since reconstruction of the system partition will lead to data loss. To prevent inadvertent deletion or overwriting of system files, this drive is not specified in the file menus. It can be accessed if a protection level (see section "Protection Level" in the Operating Manual) is revoked.

Files can be exchanged either via a memory stick or a connected network. A memory stick is connected to the USB interface and is assigned the `E:\` drive. In the case of a connected network, all network drives that can be accessed are available. The files are accessed in a "Save/Recall" dialog in the individual menus.

The files are differentiated according to their extensions; each type of file is assigned a specific file content. The extension is usually of no consequence to the user since access to the files occurs in the individual menu where only the relevant type of file is available. See [Chapter 4.7.2.1, "Extensions for User Files"](#), on page 127 for an overview of the supported file extensions.

The user data can be roughly divided into the following data types:

- **Settings**  
Settings, e.g. the frame setting of the GSM/EDGE standard, can be loaded and current setting saved to the specified file.
- **Complex modulation and control data**  
User data of this type can be loaded. It can be generated either externally or internally. For internal generation, a new list must be created which will then be edited in the data and control list editor. These functions are offered in the "Data List Management" dialog of the individual modulation menu.
- **Waveforms**  
Waveforms are generated externally (e.g. by means of the R&S WinIQSIM2 program that is supplied together with the optional Baseband Generator R&S AMU-B10) and can be loaded in the "Arbitrary Waveform Generation" dialog.



Softkeys are assigned to some of the functions and can be used for convenient operation.

---



For more information, refer to:

- [Chapter 4.8, "Legend of Front-Panel Controls"](#), on page 129 for an overview of key functions and a cross-reference between the front panel keys and the keyboard shortcuts
- to section "Instrument Functions" for a detailed description of key functions.

### Accessing files with user data

1. To access an editable user data file, select the "Save/Recall" or "File Manger" function in the individual dialog.



2. To access a loadable data file, select the "Select/New" or "File Manager" function in the individual dialog.



3. To access the "File Manager" function, press the SETUP (CTRL+E) key and select "Save/Recall > File Manager".

A "File Select" window for loading, saving or creating a file or the "File Manager" dialog for managing all files is displayed.



### Saving and loading of all instrument settings

All instrument settings are saved and loaded in the "File" menu.

To access the "File" menu, press the FILE (CTRL+S) key.

For more information, see [Chapter 5.2.8, "Storing and Loading Instrument Data - File Key"](#), on page 167.

#### 4.7.1 File Select Dialog

The "Save/Recall" dialog displays the available drives and directories. In the upper part, "Recent Data Sets", the files last used are listed.

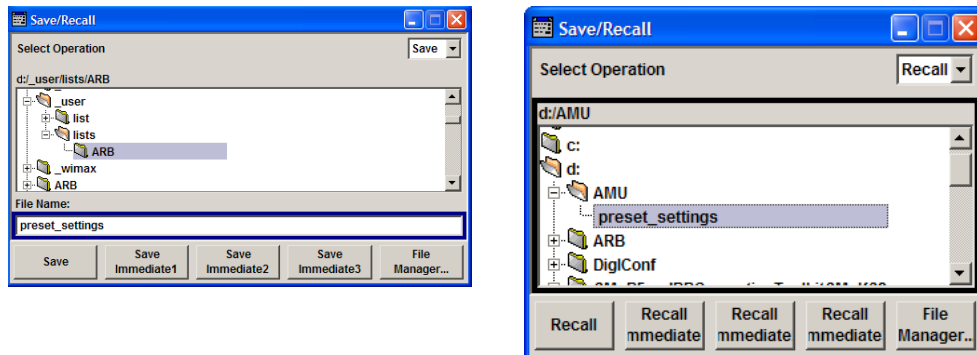

The available drives and directories and the files of the selected directory are displayed. The currently selected path is displayed above the window. Only the relevant files without file extensions are displayed. If the area is opened several times, the path last selected is displayed. When a file is saved or created, its name is user-selectable; the extension is assigned automatically and cannot be entered. The file is saved to the selected path.

In addition to the files saved by the user, some menus also offer files containing predefined contents. These files are saved to a specific directory on system drive; for this reason, this directory cannot be chosen from the "File Select" menu.

#### Example:

The following example shows the "File Select" menu of the GSM/EDGE digital standard when "Recall Predefined Frames" is selected.

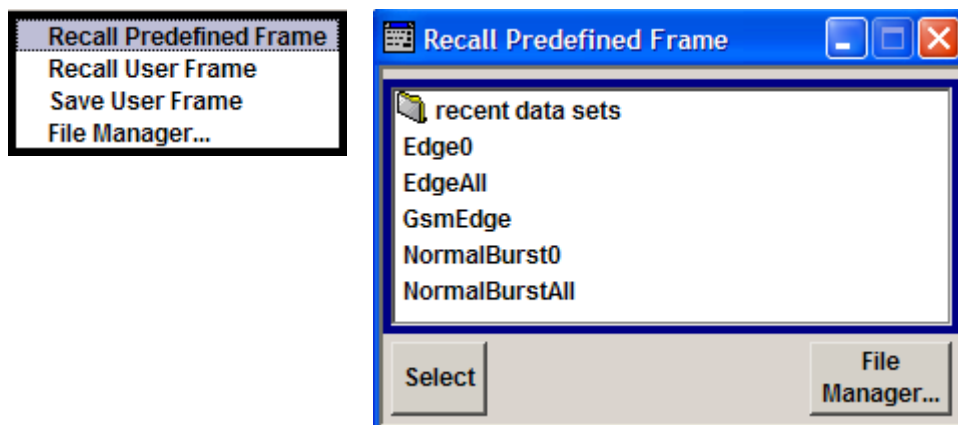

#### Working with the File Select dialog

1. Access the "File Select" dialog (see ["Accessing files with user data"](#) on page 124).
2. Navigate in the "File Select" dialog.
3. Load an existing file.  
In the "Recall Settings" dialog, mark a file and press the "Select" button.
4. Save a file.

In the "Save Settings" dialog, enter file name in the "File Name:" field.

Select the directory to which the file is to be saved and then select the "Save" button.

5. Create a new file.

To create a new file, use the "Save Settings" functionality, i.e. specify file name and directory and save the file.

The created file is empty; it must be filled with the necessary values in the individual editor.

## 4.7.2 File Manager

The "File Manager" allows general file management such as copying, shifting, renaming and deleting files as well as generating new directories.

Thus, also externally created files, for example waveforms created by using the R&S®WinIQSIM2 program, can be saved to the R&S AMU by copying them from a memory stick or a network to the internal hard disk.

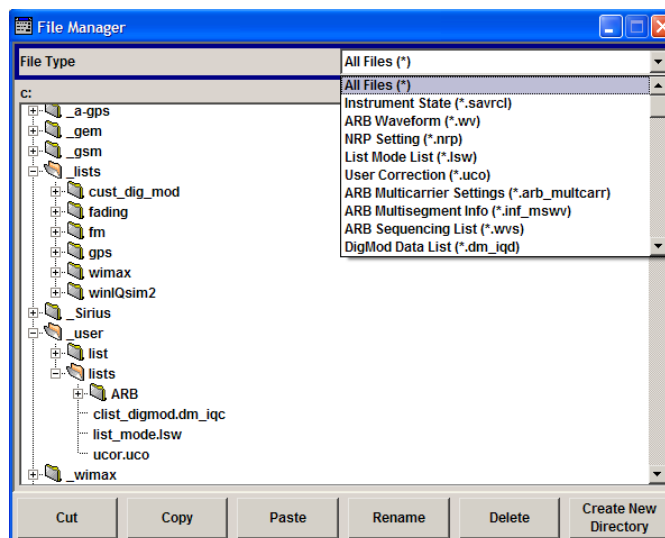

Use the "File Type" to select a file type from the list. This can be used to process either all files (all files (\*) selection) or a specific selection of files. See [Chapter 4.7.2.1, "Extensions for User Files"](#), on page 127 for an overview of the supported file extensions. The available drives and directories and the files of the selected directory are displayed. The currently selected path is displayed above the windows. If the area is opened several times, the path last selected is displayed. Unlike the "File Select" window, the "File Manager" displays the full file names including extensions.

### Working with the File Manager dialog

1. Accessing the "File Manager" dialog (see ["Accessing files with user data"](#) on page 124).
2. Navigating in the "File Manager" dialog.

Operation is very similar to the operation of a standard Windows explorer.

### 3. Moving, duplicating, deleting or renaming files

To move a file, select the file and press the "Cut" button. Mark the directory to which the file is to be moved and select the "Paste" button. If the target directory already contains a file with the same name, a confirmation query is displayed to confirm overwriting of this file.

Perform the similar steps and cut/copy/rename/delete the file.

**Tip:** The operation corresponds to the Windows concept.

### 4. Creating a new directory

Mark drive or directory level where the new directory is to be created, select the "Create New Directory" button and enter the name of the new directory in the entry window that opens. Confirm with ENTER.

#### 4.7.2.1 Extensions for User Files

The following table lists all available file extensions for user files. The currently available files on the instrument depend on the installed options.

**Table 4-1: List of the automatically assigned file extensions in the instrument**

Function/Digital Standard	List type	Contents	File suffix
Instrument State	Settings	Instrument settings	*.savrcl
"Arbitrary Waveform Generator"	Waveform	ARB waveforms ARB multi segment waveforms	*.wv
	Waveform	ARB multi carrier settings	*.arb_multcarr
	Configuration data	Configuration file for creation of multisegment ARB waveforms	*.inf_mswv
	Play List	ARB Sequencing List	*.wvs
"DM"	Data List	Digital modulation data	*.dm_iqd *.tdm
	Control List	Data to control digital modulation	*.dm_iqc
	Settings	Digital modulation settings	*.dm
	User Standard	Digital modulation user standard	*.dm_stu
	User Mapping	Digital modulation user mapping	*.vam
	User Filter	Digital modulation user filter	*.vaf
EX-IQ-BOX	User Settings	EX-IQ-BOX User Defined Settings	*.iqbox
"Fading"	Fading	Fading data	*.fad
"GSM/EDGE"	Settings	GSM/EDGE settings	*.gsm
	Slot	User-defined slot data	*.gsm_slu
	Frame	User-defined frame data	*.gsm_fu

Function/Digital Standard	List type	Contents	File suffix
	Slot	Higher symbol rate slot	*.gsm_hslu
	Frame	Higher symbol rate frame	*.gsm_hfu
"Bluetooth"	Bluetooth Settings	Complete setting of the Bluetooth menu	*.bto
"TETRA"	TETRA Settings	Complete setting of the TETRA menu	*.tetra
"3GPP FDD"	Settings	Complete setting of the 3GPP (FDD) menu	*.3g
	Settings	Channel coding enhanced DPCH channels (downlink)	*.3g_ccod_dl_s
	Settings	Channel coding enhanced DPDCH channels (uplink)	*.3g_ccod_ul
"CDMA2000"	Settings	Complete setting of the CDMA2000 menu	*.cdma2k
"TD-SCDMA2000"	Settings	Complete setting of the TD-SCDMA2000 menu	*.tdscdma
	Settings	Test Model for TD-SCDMA2000	*.tdtmd
1xEV-DO	Settings	Complete setting of the 1xEV-DO menu	*.evdo
"IEEE 802.11 WLAN"	Settings	Complete setting of the IEEE 802.11 WLAN menu	*.wlan
"IEEE 802.11 n WLAN"	Settings	Complete setting of the IEEE 802.11n WLAN menu	*.wlann
	Settings	Beamforming data	*.bmf
"IEEE 802.16 WiMAX"	Settings	Complete setting of the IEEE 802.16 WiMAX menu	*.wimax
"EUTRA/LTE"	Settings	Complete setting of the EUTRA/LTE menu	*.eutra
	Settings	TDD Settings	*.lte_tdd
	Settings	User-defined IQ-File	*.iqw
"GPS"	Settings	Complete setting of the GPS/A-GPS menu	*.gps
	Settings	GPS Almanac Settings	*.txt *.alm *.al3
	Settings	GPS Waypoints File	*.txt
	Settings	GPS Generated Almanac File	*rs_al *.rs_yuma
	Settings	GPS Ionospheric File	*.rs_ion
	Settings	GPS Navigation Data	*.rs_nav
	Settings	GPS UTC File	*.rs_utc *.rs_acq
"FM-Stereo"	Settings	Complete setting of the FM-Stereo menu	*.fmstereo



Function/Digital Standard	List type	Contents	File suffix
	Settings	FM-Stereo Group Type Settings	*.fm_gt
	Settings	FM-Stereo Group Hex Type Settings	*.fm_ghex
	Waveform File	Waveform File	*.wav
"Sirius"	Settings	Complete setting of the Sirius menu	*.sirius
"XM-Radio"	Settings	Complete setting of the XM-Radio menu	*.xmradio
	Settings	XM-Radio TWTA Data	*.twta
"DVB"	Settings	Complete setting of the DVB menu	*.dvb
	Settings	DVB Transport Stream	*.gts *.ts *.trp
"DAB/T-DMB"	Settings	Complete setting of the DAB/T-DMB menu	*.dab
	Settings	DAB ETI Files	*.eti *.xeti
NFC	Settings	Complete setting of the NFC menu	*.nfc

## 4.8 Legend of Front-Panel Controls

The following table lists all key functions available on the front panel. Key combinations used on the PC keyboard to trigger key functions on the instrument front panel are also described. Keyboard labels are described in alphabetical order.

In addition, a front panel key emulation and an on-screen keyboard can be used for manual operation by mouse only.

**Table 4-2: Cross-reference between the front panel keys and keyboard shortcuts**

Front-panel key	Key of PC keyboard	Function
Turning the rotary knob	Tab key (towards the right) Shift + Tab (towards the left)	Sets the cursor with the rotary knob.
Pressing the rotary knob	Enter	Pressing the rotary knob confirms an entry; it has the same function as the ENTER key.
Arrow keys	Arrow keys	Moves the cursor.
*1 / dB(m)	ALT + F12	Confirms entries in the base unit and values without a unit.  The unit dBm is inactive.
. / *...#	. / *...#	Enters a period/decimal point. Enters a special character.
+/- / A<->a	- / (shift+) a—z	Enters the sign.  Switches between upper-case and lower-case letters.

Front-panel key	Key of PC keyboard	Function
0-9 / a...z	CTRL+ 0-9 / a...z CTRL	Enters the number/letter.
BACKSPACE	Backspace	Clears the last entry (number, sign or decimal point)
CLOSE	CTRL + G	Closes an active menu.
DIAGRAM	CTRL+ D	Sets the cursor on the block diagram and hides all menus.
ENTER	Enter	Terminates an entry.
ESC	ESC	Selects the next higher menu/selection level. When the editing mode is exited with ESC, the previous value is restored.
FILE	CTRL + S	Activates the menu for storing instrument settings.
BASEBD LEVEL	CTRL+ L	Activates the frequency entry.
BASEBD ON/OFF	CTRL + R	Switches the baseband output signal on and off. In the two-path mode the BASEBD ON/OFF key switches all signals off. A second stroke restores the status that was active before the last switch off. "I/Q OUT OFF" is displayed in the status bar.
G/n / dBuV	ALT + F9	Selects the unit Giga/Nano. The unit dBuV is inactive.
HCOPY	CTRL+ Y	Opens the menu for configuring and starting a hardcopy.
HELP	F1	Opens/closes context-sensitive help.
HIDE	CTRL+ H	Minimizes the active menu. Pressing the respective button in the Winbar opens the menu again.
INFO	CTRL + I	Opens/closes the info window
INSERT	Ins	Activates the insert mode.
k/m / uV	ALT + F11	Selects the units Kilo/Milli and uV for levels.
LOCAL	CTRL + Q	Switches the instrument from remote control to manual control.
M/u / uV	ALT + F10	Selects the units Mega/Micro and uV for levels.
MENU	CTRL + M	Calls the menu selection list.
ON/OFF TOGGLE	CTRL + T	Switches a block or parameter on/off. Toggles between the different possibilities of setting a selection parameter.
PRESET	CTRL + P	Restores a defined basic instrument setup.
REARR	CTRL + A	Adjusts the size of the active menu to use the whole height of the display.
RECALCULATE	CTRL + C	Starts recalculation of the signal.
SETUP	CTRL + E	Opens the setup menu for general instrument settings.

Front-panel key	Key of PC keyboard	Function
Softkeys	CTRL + F1 – F8	Triggers the function assigned to the softkey.
WINBAR	CTRL + W	

### 4.8.1 Front Panel Key Emulation

The R&S AMU provides a front panel key emulation to enable execution of the front panel key functions by mouse e.g. for remote access. The emulation is called by a right mouse click. The front panel key functions are executed by a mouse click on the associated button.



### 4.8.2 On-screen Keyboard

In addition, the operating system provides a keyboard emulation that can be used for system settings if no external keyboard but a mouse is available.

To access the on-Screen Keyboard, select "Start > Programs > Accessories > Accessibility > On-Screen Keyboard".





## 5 Instrument Function

### 5.1 Overview of Instrument Functions

This chapter explains the functions of the R&S AMU and the options available in the setting menus. The associated SCPI command is specified for each parameter (where applicable).

The description begins with the general instrument settings which do not directly affect signal generation. The majority of these settings can be accessed by means of front-panel softkey menus and not by means of function block menus.

One exception is, for example, the signal graphics which are called up in the "Graphics" block.

All functions for the generation of the baseband signals are described, following the order of the signal process - generation of internal baseband signals, input of external baseband signals, fading, noise generation and impairment and the analog and digital signal outputs. These functions are accessed by the means of the function blocks "Baseband A/B", "Baseband Input A/B", "Fading A/B", "AWGN/IMP A/B" and "I/Q Out A/B".

The general instrument settings include various functions, such as:

- Setting a defined basic setup using the PRESET key  
see [Chapter 5.2.2, "Default Instrument Settings - Preset Key"](#), on page 136
- Switching from remote control to manual control using the LOCAL key  
see [Chapter 5.2.4, "Switching to Manual Control - Local Key"](#), on page 162
- Configuring the generator and its interfaces in the "Setup" menu - e.g. setting the GPIB address, starting an adjustment, querying instrument data  
see [Chapter 5.2.3, "General Configuration of Instrument - Setup Key"](#), on page 137
- Generating a hardcopy of the display using the HCOPY key  
see [Chapter 5.2.5, "Generating a Hard Copy of the Display"](#), on page 163
- Calling up the online help using the HELP key  
see [Chapter 5.2.7, "Help System - Help Key"](#), on page 166
- Querying messages using the INFO key  
see [Chapter 5.2.6, "Messages - Info Key"](#), on page 166
- Loading and storing complete instrument settings in the "File" menu  
see [Chapter 5.2.8, "Storing and Loading Instrument Data - File Key"](#), on page 167
- Calling up the baseband signal graphics in the "Graphics" function block  
see [Chapter 5.3, "Graphical Display - Graphics"](#), on page 177

The integrated bit error rate and block error tester is configured and activated in the "BERT" function block:

- Bit error rate and block error measurement  
see [Chapter 5.4, "Bit and Block Error Rate Measurements - BERT Block"](#), on page 189

Noise can be added to the baseband signal and the baseband signal can be impaired or faded. It is possible to output the baseband signal with impairments analog (single ended and differential) and digital via the "I/Q Out" function block.

- Impairing the signal  
see [Chapter 5.6.1, "Impairments"](#), on page 223
- Adding noise  
see [Chapter 5.6.2, "AWGN - Noise Generator"](#), on page 226
- Fading the signal  
see description "Fading Simulation - Fader Block"

The baseband signal is available at the I/O outputs.

- Single Ended and Differential I/Q Output  
see [Chapter 5.5.3, "Analog I/Q Output Settings"](#), on page 212
- Digital I/Q Output  
see [Chapter 5.5.4, "Digital I/Q Output Settings"](#), on page 217

The R&S AMU offers various possibilities for generating digital modulation signals in compliance with the definitions of digital standards or with characteristics which can to a large extent be freely defined. The range of software options for this is being extended continuously.

- Baseband signals - Introduction  
see [Chapter 5.7, "Baseband Signal - Baseband Block"](#), on page 235
- External Baseband signals  
see [Chapter 5.8, "External Baseband Signal - Baseband Input"](#), on page 367
- Digital modulation  
see [Chapter 5.7.3, "Digital Modulation - Custom Digital Modulation"](#), on page 255
- Arbitrary waveform generator ARB  
see [Chapter 5.7.4, "Arbitrary Waveform Generator ARB"](#), on page 296
- Multi Carrier CW signals  
see [Chapter 5.7.5, "Multi Carrier Continuous Wave"](#), on page 354
- Digital standard GSM/EDGE  
see description "Digital Standard GSM/EDGE"
- Digital standard Bluetooth/EDR  
see description "Digital Standard Bluetooth® Enhanced Data Rate"
- Digital standard TETRA2  
see description "Digital Standard TETRA Release 2"
- Digital standard 3GPP FDD (WCDMA)  
see description "Digital Standard 3GPP FDD (WCDMA)"
- Digital standard CDMA2000®  
see description "Digital Standard CDMA2000®"
- Digital standard TD-SCDMA  
see description "Digital Standard TD-SCDMA"
- Digital standard 1xEV-DO  
see description "Digital Standard 1xEV-DO"
- Digital standard IEEE 802.11 (a/b/g) (WLAN)  
see description "Digital Standard IEEE 802.11 (a/b/g) (WLAN)"

- Digital standard IEEE 802.11n (WLAN-N)  
see description "Digital Standard IEEE 802.-11n (WLAN-N)"
- Digital standard IEEE 802.16 (WiMAX)  
see description "Digital Standard IEEE 802.16 (WiMAX)"
- Digital Standard EUTRA/LTE  
see description "Digital Standard EUTRA/LTE"
- Digital standard GPS/A-GPS  
see description "Digital Standard GPS"
- FM Stereo/RDS  
see description "FM Stereo/RDS"
- Sirius Radio  
see description "Sirius Radio"
- Digital Standard XM Radio  
see description "Digital Standard XM Radio"
- Digital Standard DVB-H  
see description "Digital Standard DVB-H"
- Digital Standard DAB / T-DMB  
see description "Digital Standard DVB / T-DMB"
- Digital Standard NFC/EMV  
see description "Digital Standard NFC A/B/F and EMVCo"

In addition, external baseband signals can be fed into the baseband path with the aid of the external Digital Interface Module R&S EX-IQ-BOX.

- Digital Interface Module  
see description "Digital Interface Module R&S EX-IQ-BOX".

## 5.2 General Instrument Settings

### 5.2.1 Overview of General Instrument Settings

This section describes the settings which do not directly affect signal generation. Most of these settings can only be accessed by means of menus which are opened using keys or key combinations on the external keyboard or keys on the front panel key emulation.

This does not apply to the graphical representation of output signals which is activated in the "Graphics" function block, or settings which can additionally be called up in the menus of the function blocks, e.g. input configuration which is possible in the "Setup" menu and in almost every menu of the "Baseband" function block.

See also [Chapter 4.8, "Legend of Front-Panel Controls"](#), on page 129.

The general instrument settings therefore affect various functions, such as storing instrument settings using the FILE key or setting the GPIB address in the menu of the

SETUP key. The order in which the descriptions are given corresponds to the layout of the keys on the front panel of the R&S AMU (from top left to bottom right).

## 5.2.2 Default Instrument Settings - Preset Key

The PRESET key performs a defined instrument setup. All parameters and switching states are preset (also those of inactive operating modes). The default instrument settings provide a reproducible initial basis for further settings.

However, functions concerning the integration of the instrument in a measurement setup are not changed, for example the GPIB address or reference oscillator settings.

In addition, only those settings associated with the menu can be reset directly in the individual dialogs, like the digital modulation settings in the "Custom Digital Mod" menu. These settings are identical with the values set with the PRESET key.

When the instrument is switched on, it is not the preset state that is active, but rather the instrument state that was set before the instrument was switched on.

User-defined instrument states can be accessed and stored in the "File" menu.



Resetting the instrument to the factory state is possible with the [Factory Preset](#) function.

### Preset

Presets all parameters and switching states.

The following list gives an overview of the presets for the most important generator settings. The other presets can be found in the preset tables of the individual menus and the information accompanying the remote commands.

- "Reference frequency" = Internal; adjustment off
- "Offsets" = 0
- "Modulations State" = Off

Settings that are not affected by the PRESET key

- Reference frequency settings ("Ref Oscillator" menu)
- Power on settings ("Level/EMF" menu)
- Network settings ("Setup" menu)
- GPIB address ("Setup" menu)
- Password and settings protected by passwords ("Setup" menu)
- Start/Stop Display Update ("Setup" menu)
- Display and keyboard settings ("Setup" menu)

**Note:** In remote control it is possible to preset the settings of the two instrument path separately (see [Chapter 7.3, "Preset Commands"](#), on page 430).

Resetting the instrument to the factory state is possible in the [Factory Preset](#) dialog.

Remote command:

\*[RST](#) on page 428



### 5.2.3 General Configuration of Instrument - Setup Key

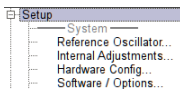

The "Setup" menu provides access to basic instrument settings, regardless of the currently set operating mode or measurement. It contains information on the instrument's equipment, and comprises all settings for the general configuration of the instrument and its interfaces.

To access the "Setup" menu, press the SETUP key.

The "Setup" menu is divided into functional sections as follows:

- "System": covers general instrument parameters.
- "Test": used to perform function tests.
- "Environment": used to configure the controller interfaces.
- "Remote": used to configure the remote control interfaces.
- "Protection": used to set the protection level for service functions and security settings.
- "Settings": used to save or recall instrument settings or to preset the instrument to factory settings.

Most submenus of this key can be accessed only via the SETUP key or the menu tree ( MENU key), with the following exceptions:

- The "Save/Recall" dialog can also be accessed with the FILE key and is therefore described in the section on this key (see [Chapter 5.2.8, "Storing and Loading Instrument Data - File Key"](#), on page 167).
- The "Global Trigger/Clock/ External Inputs" dialog is also available in all modulation dialogs of the "Baseband" function block where it can be accessed with the "Global Trigger/Clock Settings" button in the corresponding "Trigger/Marker/Clock" dialog. See also [Chapter 5.2.3.9, "Global Trigger/Clock/External Input Settings"](#), on page 148.

#### 5.2.3.1 Reference Oscillator

The R&S AMU is equipped with an internal reference oscillator that generates a reference frequency of 10 MHz. It is used as internal reference source for the synthesizer and the local oscillator. Alternatively, you can apply an external reference signal.

Regardless of the used reference source (internal or external), the R&S AMU always provides the configured reference frequency at the output. You can use it, for example to synchronize several interconnected instruments.

The reference frequency setting is effective for both paths.



The settings of the reference oscillator are not affected by an instrument preset ("PRE-SET" key).

The following examples briefly explain the possible test setups and the settings to be considered.

- Internal  $f_{\text{ref}} = 10 \text{ MHz}$  (10 MHz REF OUT)

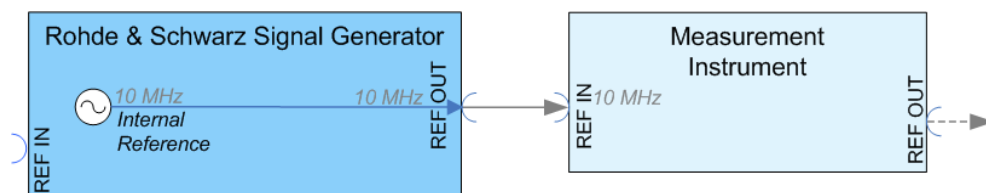

Figure 5-1: Synchronizing a subsequent instrument using the internal 10 MHz reference signal of the R&S AMU

The internal reference oscillator supplies the reference frequency.

Settings:

- Source: "Internal"
- External  $f_{\text{ref}} = 10 \text{ MHz}$  (10 MHz REF OUT)

If you have a clean external reference signal with 10 MHz frequency, you can directly pass it to the output. The signal quality remains the same.

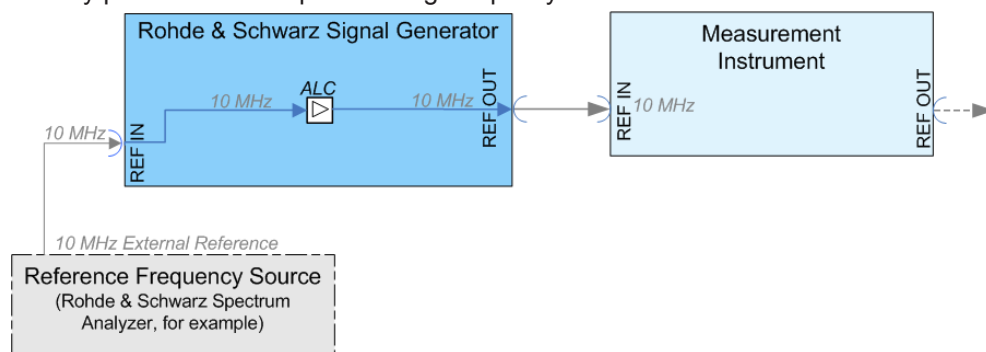

Figure 5-2: Synchronizing instruments by means of an externally applied reference signal having 10 MHz

Settings:

- Source: "External"
- External Reference Frequency: "10 MHz"

Set the additionally provided parameters, as for example the synchronization bandwidth according to the requirements of the application.

- External  $f_{\text{ref}} = 5/10/13 \text{ MHz}$  (5/10/13 MHz REF OUT)
- If you have an external reference signal with 5, 10 or 13 MHz, you can directly pass it to the output. The signal quality remains the same.

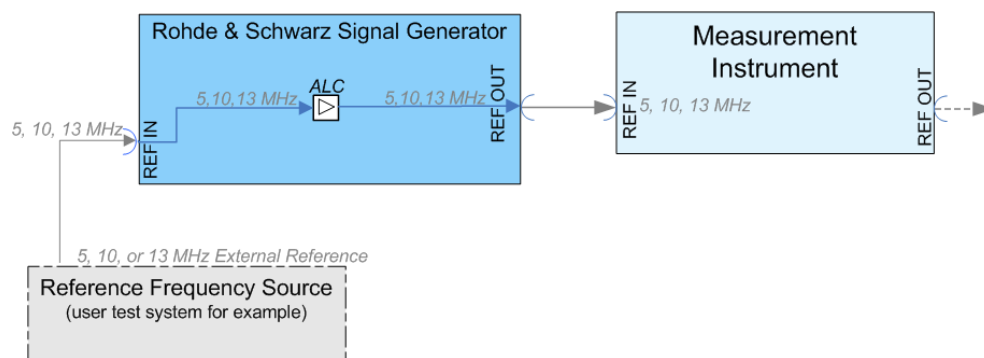

Figure 5-3: Synchronizing a subsequent instrument an externally applied reference frequency of 5, 10, or 13 MHz

Settings:

- Source: "External"
- External Reference Frequency: "5, 10 or 13 MHz"

### Input and output connectors of the reference frequency

The appropriate connectors are located at the rear panel, see "REF IN" on page 29 and "REF OUT" on page 29.

### Reference Oscillator Settings

To access the settings dialog for configuring the reference signal, perform one of the following:

- Press the SETUP key and select "Setup > System > Reference Oscillator"

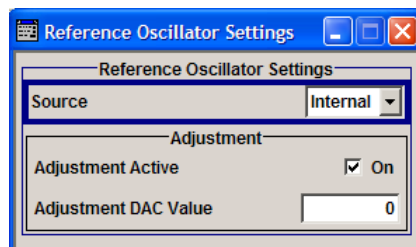
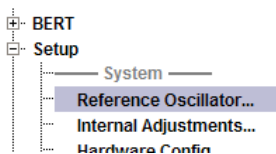

In the "Reference Oscillator Settings" dialog, you can select the signal source and frequency to be used as the reference frequency, and determine a user-defined adjustment value.

The remote commands required to define the reference oscillator settings are described in [Chapter 7.15.7, "SOURce:ROSCillator Subsystem"](#), on page 654.

### Source

Selects the source of the reference frequency.

See [Chapter 5.2.3.1, "Reference Oscillator"](#), on page 137, which provides an overview of the different test scenarios for configuring the reference frequency.

"Internal" Uses the internal 10 MHz reference signal, either with the calibrated or a user-defined adjustment value.

"External" Uses an external reference signal. The frequency of the external reference signal must be selected under "External Reference Frequency" on page 140.

Remote command:

`[ :SOURce ] :ROSCillator :SOURce` on page 656

#### External Reference Frequency

Determines the frequency of the external reference signal.

You can use an external reference signal having a frequency of 5 MHz, 10 MHz or 13 MHz.

Remote command:

`[ :SOURce ] :ROSCillator :EXTernal :FREQuency` on page 655

#### Adjustment Active

Selects the adjustment mode for the internal reference signal.

"OFF" Uses the calibrated internal reference frequency.

"ON" Allows you to apply a deviation to the internal reference frequency, according to your requirements. To enter the value, use [Adjustment DAC Value](#).

Remote command:

`[ :SOURce ] :ROSCillator [ :INTernal ] :ADJust [ :STATe ]` on page 655

#### Adjustment DAC Value

Sets a user-defined deviation for the internal reference frequency. This value takes effect when it is activated with [Adjustment Active](#). "0" represents the calibrated state. The setting range depends on the reference oscillator type and its factory calibration value.

**Note:** A factory preset resets this setting to the calibration value of the instrument.

Remote command:

`[ :SOURce ] :ROSCillator [ :INTernal ] :ADJust :VALue` on page 655

### 5.2.3.2 Internal Adjustments

The R&S AMU is extremely accurate due to the integrated adjustment procedures, which you can execute directly on the instrument.



Self-calibration routines that do require additional (external) measurement equipment are either described in the Service Manual of the instrument, or they require to be performed by a Rohde & Schwarz service center.

#### NOTICE

##### Risk of invalid adjustment

In order to achieve correct adjustment of the instrument, make sure that the instrument is warm before performing adjustments. The warm-up time is 30 minutes.

### When to perform adjustments?

It is recommended to perform internal adjustments prior to any application that requires a maximum of level and frequency accuracy, especially when a long period of time has passed or if the ambient temperature of the instrument significantly differs from the one of the last adjustment.

### Additional Information to the Adjustments

During adjustments, a progress indicator shows the status of the process. If any error occurs, the process aborts and an error message appears in the info line.

The extent of the adjustments depends on the installed options.

You can perform internal adjustments in each path separately.

- ▶ To access the settings for internal adjustments, press the SETUP key and select "System > Internal Adjustments".

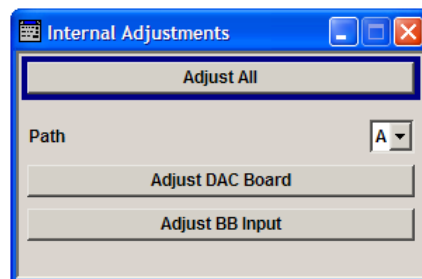

In this dialog you can perform internal calibration routines.

The remote commands required to define these settings are described in [Chapter 7.6, "CALibration Subsystem"](#), on page 463.

#### Adjust All

Performs all available internal calibration routines of the instrument, considering all installed paths.

Remote command:

`:CALibration<hw>:ALL[:MEASure]?` on page 463

#### Path (Internal Adjustments)

Selects the path for which the following adjustments are to be performed. With remote control, the path is selected using the numerical suffix under CALibrate.

Remote command:

n.a.

#### Adjust DAC Board

Performs all adjustments which affect the DAC board of the selected path.

Remote command:

`:CALibration<hw>:DAC[:MEASure]?` on page 464

**Adjust Baseband Input**

Starts the adjustment for the baseband input. The I/Q input is adjusted with respect to DC offset and gain.

Remote command:

[:CALibration<hw>:BBIN\[:MEASure\]?](#) on page 464

**5.2.3.3 Hardware Config**

In the "Hardware Config" dialog, the installed assemblies together with their variants and revision states can be displayed for servicing purposes.

To open the "Hardware Config" dialog, select "System" and press the SETUP or MENU key.

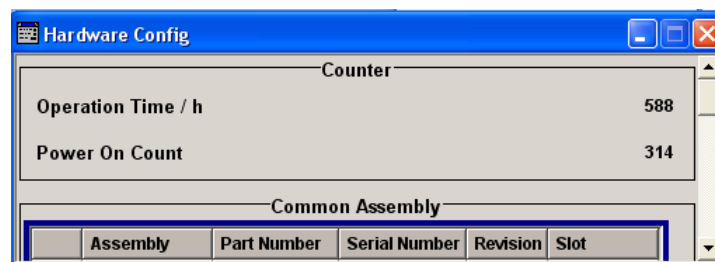

Section "Counter" in the upper part of the menu shows the "Operation Time" (in hours) and the number of power-on ("Power On Counter").

The second part of the menu is a table that lists the installed assemblies. It is divided into the sections:

- "Common Assembly"
- "Baseband Assembly"

**Operation Time / h**

Displays the operation time in hours.

Remote command:

[:DIAGnostic:INFO:OTIME?](#) on page 467

**Power On Count**

Displays the number of power-on.

Remote command:

[:DIAGnostic:INFO:POCount?](#) on page 468

**Assembly**

The tables list the installed assemblies.

"Path" Shows the path to which the assembly belongs.

"Assembly" Assembly name

"Part Number" Part Number of assembly

"Serial Number" Serial Number of assembly

"Revision"	Revision state of assembly
"Slot"	Indicates whether the assembly is connected to the serial bus or PCI bus.

Remote command:

:DIAGnostic<hw>:BGInfo? on page 466

### 5.2.3.4 Software / Options

The "Software/Options" dialog shows the firmware version of the instrument software as well as all installed hardware and software options.



Software options purchased at a later stage can be activated with a keycode. The activation code is supplied with the software option. How to install options is described in Chapter 4 of the Service Manual (supplied with the instrument).

The installation of hardware options purchased at a later stage is also described in Chapter 4 of the Service Manual (supplied with the instrument). Most hardware options need to be installed at an authorized Rohde&Schwarz service shop.

To access the "Software/Options" dialog, select "System" and press the SETUP or MENU key.

The menu is divided into the following sections:

- "Firmware"
- "Hardware Options"
- "Software Options"
- "WinIQSIM"
- "Loaded Modules"

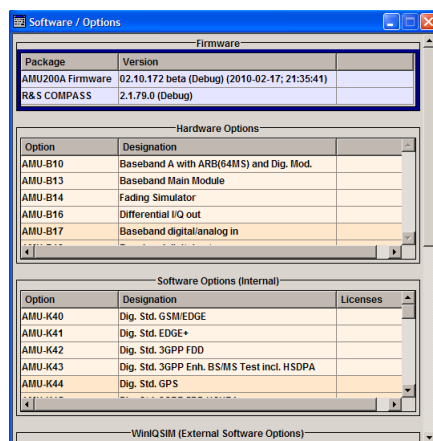

#### Firmware

The Firmware section of the menu shows the firmware version and the version of the software platform.

**Note:** Your instrument is delivered with the latest firmware version available. Firmware updates as well as the Release Notes describing the improvements and modifications

are provided on the Internet at the download site of the Rohde & Schwarz Signal generator home page. This home page always offers the latest information on your signal generator, e.g. also on changes of the firmware update procedure.

Remote command:

n.a.

### Hardware Options / Software Options

The tables in the sections "Hardware", "Software" and "WinIQSIM2" list the installed hardware and software options.

"Option"            Short name of option

"Designation"    Name of Option

"Licenses"        (optional)  
Number of licenses.

The licenses for the software options are "floating licenses". This means that in the case of two-path instruments just one license is required to use the option for either of the two paths. However, two licenses must be purchased to use an option on both paths simultaneously.

"Expiration Date"

For regular options, "Permanent" is indicated in this column. Some options are available as trial versions. This column shows their expiration date. After this date, the option is no longer available on the instrument.

Remote command:

\*OPT? on page 427

\*IDN? on page 427

### Loaded Modules

Section "Loaded Modules" is provided for service purposes. It lists all loaded software modules with their versions and offers a short description of each module.

Remote command:

n.a.

#### 5.2.3.5 Manage License Keys

This dialog is the central dialog for managing licenses, like enabling newly purchased and/or newly registered options or performing the required instrument related steps during the process of unregistration of licenses.



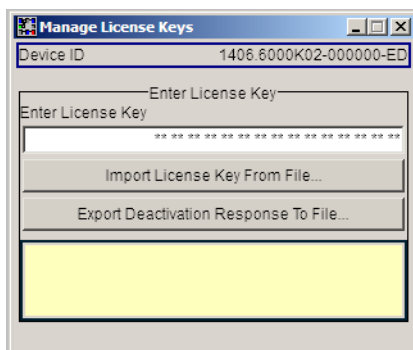

An option is ready to operate after it is enabled by means of a license key code supplied with the option. The license key is delivered as a file or on paper. Unregistered licenses must be registered for a particular instrument prior to the corresponding option can be enabled for operation.



### License Registration

If your purchased license is delivered unregistered, you must register it before you can activate the option.

For detailed information about the license registration, refer to the installation instructions provided with the option (Supplement A) and the documentation of the online tool "Manage Licenses" (<https://extranet.rohde-schwarz.com/service>).



Only if the R&S AMU is equipped with an older firmware version, a firmware update prior to enabling the software option may be required. The information on the valid firmware versions for the purchased software option is provided together with the option.

The firmware update is described in the service manual, chapter 4.

### Device ID

Displays the instrument specific identification number. The device ID is a unique string with the following structure:

```
<stock number>-<serial number>-<checksum>
```

### Enter License Key

Type here the license key provided with the option.

For license keys delivered as a file, use [Import License Key from File...](#)

### Import License Key from File...

Opens a dialog for selecting the file with the license key.

### Export Deactivation Response to File...

Exports the generated deactivation response key to a file and opens a file management dialog to save the file. This key is required during the unregistration process.

### Status Information

Displays status information.

### 5.2.3.6 Update

After a firmware update it is occasionally required to also update the "PCI-FPGA". This is enabled in the "Update" dialog.

At the first start of the new firmware, a message appears during the boot process if a "PCI-FPGA" update is required. Execute a PCI-FPGA update by pressing the "PCI-FPGA" button.

#### NOTICE

#### Impairment of instrument functions

To avoid impairment of instrument functions, the update of the "PCI-FPGA" must not be cancelled and the instrument must not be switched off during this update.

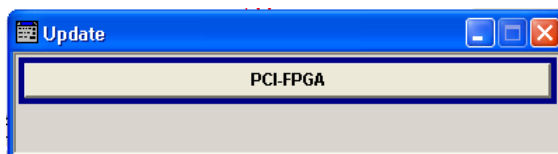

### 5.2.3.7 Display Update

The "Start/Stop Display Update" dialog provides the possibility to switch off update of the displayed parameters in order to increase speed for certain settings.

The indicated values are not updated and may therefore differ from the internal, used values.

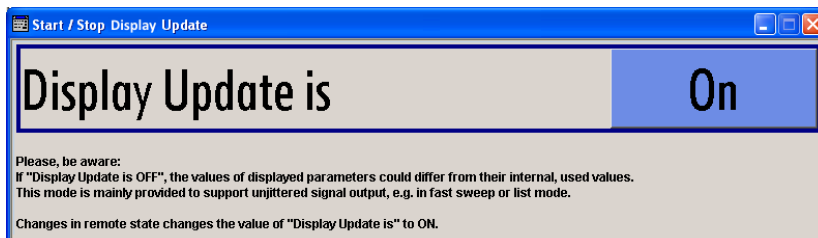

#### Display Update is On/Off

Switches on/off update of the displayed parameters.

Switching off the update of the displayed parameters increases the speed for certain settings.

**Note:** For optimum sweep performance with short dwell times and for fast settling times, it is recommended to switch off the display update .

Remote command:

:SYSTem:DISPlay:UPDate on page 666

### 5.2.3.8 Check Front Panel

With the functions provided in this dialog you can verify the functionality of the control keys of the R&S AMU.

In case of malfunctions, contact your Rohde & Schwarz Customer Support Center for technical support, see <http://www.customersupport@rohde-schwarz.com>.



#### Accessing the online help in the check front panel dialog or exiting via ESC

During the test, the actual functions of all keys are disabled, including the HELP and the ESC keys.

#### Check Front Panel Settings

- ▶ To access this dialog, Press the "setup" key and select "Setup > Test > Check Front Panel".

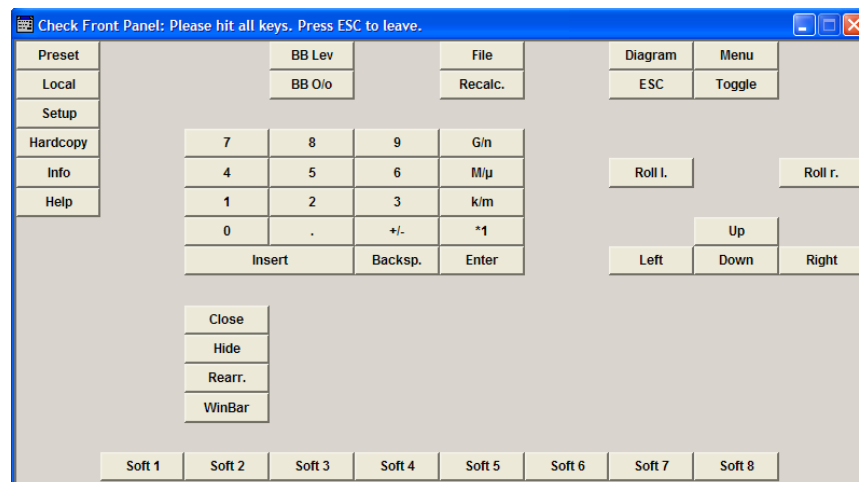

Reflecting the front panel, the "Check Front Panel" dialog contains all functions to test the operating elements of the instrument.

#### Performing the Front Panel Tests

To perform the front panel test, you operate the keys at the front panel, and check the response of the instrument in the "Check Front Panel" dialog. To perform this test properly, it is essential that you check each key of the front panel. The test is only completed, when you have verified all keys.

During the test, the actual functions of the keys are disabled.

Proceed as follows:

1. Press the SETUP key.
2. Select "Test > Check Front Panel"  
The "Check Front Panel" dialog opens.

3. Press a key on the front panel.  
Check if the corresponding key in the "Check Front Panel" dialog turns green.
4. Press the same key a second time.  
Check that the key in the dialog turns red.  
**Note:** Pressing the same key again has no further effect, with the exception of the ESC key, see [Press the ESC key a third time](#).
5. Continue with the next key on the front panel and repeat [step 3](#) to [step 5](#) until all keys are tested.

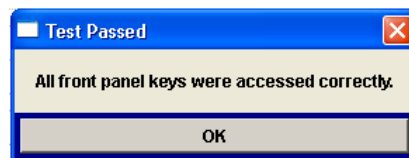

The test is completed, when each key is verified successfully, confirmed by a "Test passed" message.

Select "OK" to exit the test.

- ▶ Press the ESC key a third time.  
Exits the "Check Front Panel" dialog, even if you have not yet checked all the keys.

Expected responses:

- Pressing a key once (green), pressing twice (red)
- Pressing the ESC key a third time exits the dialog.

If you detect a malfunction, for example, you press the front panel key the first time, and the color of the button in the dialog turns red (instead of green), the front panel key may be stuck. In this case, contact the Rohde & Schwarz Customer Support Center for technical support, see <http://www.customersupport@rohde-schwarz.com>.

### 5.2.3.9 Global Trigger/Clock/External Input Settings

The "Global Trigger/Clock/External Inputs" menu can be opened using the SETUP or MENU key under the "Setup" menu as well as in all clock and trigger menus of the "Baseband" function block.

This menu is used to determine the physical characteristics of the input connectors for trigger, clock and control signals.

The user inputs/outputs (BNC connector and pins of the AUX I/O connector) are assigned in the dialog ["User Marker AUX I/O"](#).

A common trigger threshold and input impedance is effective for all trigger and control signal inputs (Path A and Path B). The settings influence the digital modulations, the generation of waveforms or multicarrier signals, and all digital standards. Irrespective of this, a common threshold and input impedance is effective for the serial and parallel data input (Path A only). These data sources are available for digital modulation ("Custom Digital Modulation").

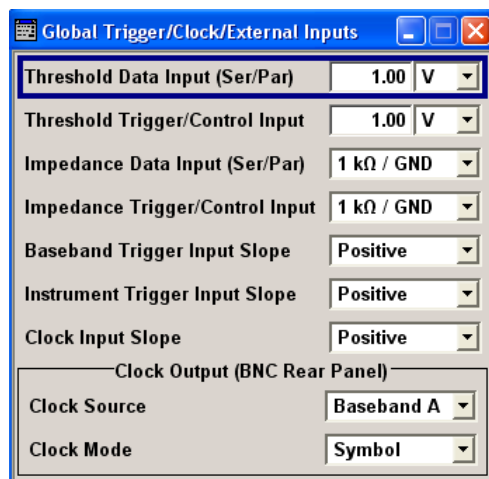

### Threshold Data Input

Sets the high/low threshold in volts for the serial and parallel data input.

The serial data is input at the DATA connector of the instrument. The parallel data is input via the DATA pins of the AUX I/O interface.

Remote command:

[\[:SOURce\]:INPut:DATA:THReshold](#) on page 636

### Threshold Trigger/Control Input

Sets the high/low threshold in volts for the trigger and control signal inputs of the base-band section.

The setting affects the TRIGGER 1 and TRIGGER 2 inputs (BNC connectors) and the CW, BURST and LEV\_ATT inputs of the AUX I/O interface.

Remote command:

[\[:SOURce\]:INPut:TRIGger:LEVel](#) on page 638

### Impedance Data Input

Selects the input impedance for the serial and parallel data inputs.

50 Ohm/GND should be selected for high clock rates.

The serial data is input at the DATA connector of the instrument. The parallel data is input via the DATA pins of the AUX I/O interface.

Remote command:

[\[:SOURce\]:INPut:DATA:IMPedance](#) on page 636

### Impedance Trigger/Control Input

Selects the input impedance for the external trigger and control signal inputs.

50 Ohm/GND should be selected for high clock rates.

The setting affects the TRIGGER 1 and TRIGGER 2 inputs (BNC connectors) and the CW, BURST and LEV\_ATT inputs of the AUX I/O interface.

Remote command:

[\[:SOURce\]:INPut:TRIGger:IMPedance](#) on page 637

**Baseband Trigger Input Slope**

Selects the polarity of the active slope of an externally applied trigger signal.

This setting affects the TRIGGER inputs (BNC connectors).

Remote command:

[\[:SOURce\]:INPut:TRIGger:BBANd:SLOPe](#) on page 637

**Instrument Trigger Input Slope**

Sets the polarity of the active slope of an externally applied instrument trigger.

This setting applies to both paths. It affects the INSTR TRIG for path A and the INST TRIG B input of the AUX I/O interface for path B.

"Positive" activates the rising edge of the trigger signal.

"Negative" activates the falling edge of the trigger signal.

Remote command:

[\[:SOURce\]:INPut:TRIGger:SLOPe](#) on page 638

**Clock Input Slope**

Sets the polarity of the active slope of an externally applied bit clock pulse or symbol clock pulse.

This setting affects the CLOCK input (BNC connector).

An external clock signal can only be supplied for Path A.

Remote command:

[:CLOCK:INPut:SLOPe](#) on page 465

**Clock Output Source**

Indicates the path for which the clock signal at the CLOCK OUT connector is to be output (always Path A).

This setting is only possible for two-path instruments.

Remote command:

[:CLOCK:OUTPut:SOURce](#) on page 466

**Clock Output Mode**

Sets the output of bit or symbol clock pulses at the CLOCK OUT connector at the rear panel.

Remote command:

[:CLOCK:OUTPut:MODE](#) on page 465

### 5.2.3.10 Display/Keyboard Settings

In the "Display/Keyboard Settings" dialog the power-save mode and external keyboard settings are made. It is opened using the SETUP or MENU key under "Environment".



### Screen Saver Active

Activates/deactivates the screen-save mode of the display.

If activated, the display including backlight is completely switched off after the elapse of the "Wait Time" when no entries via front panel, external mouse or external keyboard are made.

This mode is recommended for preserving the display especially if the instrument is exclusively operated via remote control.

Remote command:

[:DISPlay:PSAVe\[:STATe\]](#) on page 471

### Wait Time

Enters the idle time that must elapse before the display lamp is shut off when no entries are made.

Remote command:

[:DISPlay:PSAVe:HOLDoff](#) on page 470

### Layout (Keyboard Settings)

Selects the keyboard layout for the selected keyboard language.

The assignment of some keys depends on the selected layout and language.

Remote command:

[:KBOard:LAYout](#) on page 483

[:KBOard:LANGuage](#) on page 482

## 5.2.3.11 User Marker / AUX I/O Settings

The R&S AMU provides four "USER" interfaces which can be freely assigned a selection of signals and which can be configured as both inputs and outputs.

The following table gives an overview of the signals that can be applied at the USER connector.

For two-path instruments, these signals are available for Path A or B.

Table 5-1: USER Connector Signals

Signal	Description
"Marker 4"	A broad selection of suitable marker signals is offered in the marker menus of the "Baseband" block. In addition, they can be freely configured in the "Custom Dig Mod > Control List Editor" and "GSM/EDGE > Slot Marker Editor". The selected markers are activated when switching on the "Baseband" block. When using markers defined in a control list ("Marker" = "CList") the related control list must be loaded in addition ("Custom Dig Mod").
"CW Mode Out"	This signal marks the CW mode in which digital modulation ("Custom Dig Mod") is deactivated and the RF signal is output in unmodulated form. The CW signal is defined in a control list and activated by loading the control list and setting the "Modulation<-> CW Switching State" to <b>On</b> in the "More" submenu.  With standards where it is possible to change between various modulation modes, the signal indicates the active modulation mode (standard GSM: signal high (1) = modulation mode GMSK and signal low (0) = modulation mode 8PSK EDGE). In this cases, the signal is generated automatically when the standard is switched on.
"No Signal (Blank) Marker"	This signal marks the blank time in the List mode. The signal is generated automatically when the list mode is switched on.
"HOP"	This signal marks the hop trigger for frequency hopping in the List mode for "Custom Digital Mod". The hop signal is defined in a control list and activated by loading the control list in the "Custom Dig Mod" menu.
"Trigger"	This signal marks the trigger event caused by the selected trigger signal (internally or externally).  Separate trigger signals are available for Path A and B.  The trigger is defined in the respective trigger submenu of the "Baseband" block menus.

Additional signals for Path B are available in the case of two-path instruments. The corresponding signals for Path A are applied at the pins of the "AUX I/O" interface and at the BNC connector CLOCK.



**Table 5-2: USER Connector Signals (Path B)**

Signal	Description
"Clock Out"	output Path B; bit or symbol clock pulse This signal corresponds to the clock signal for digital modulations. The signal is generated automatically when the standard is switched on.
"LEV_ATT"	input/output Path B With active envelope curve control, this signal determines whether or not the signal level is attenuated. With external envelope curve control, the interface is input, otherwise output. The envelope curve control is activated in the "Custom Digital Modulation > Power Ramp Control" dialog. The internal "LEV_ATT" control signal is defined in a control list which must be loaded in the main menu.
"BURST"	This signal corresponds to the control signal for envelope curve control. With external envelope curve control, the interface is input, otherwise output. The envelope curve control is activated in the "Custom Digital Modulation > Power Ramp Control" dialog. The internal "BURST" control signal is defined in a control list which must be loaded in the main menu.

To access the "User Marker / AUX I/O" dialog:



1. Select "Setup > Environment > Global Trigger/Clock/External Inputs" or
2. In the "Baseband" function block select any digital standard, e.g. "GSM/EDGE" and select "Trigger > Global Trigger/Clock/External Inputs".

The signals are assigned to the USER interfaces in the "Mapping Configuration" section. The pin assignment of the AUX I/O connector is also displayed. An adapter between the AUX I/O interface and coaxial BNC connections is available as an accessory (accessories for R&S AMU-Z5, see data sheet).

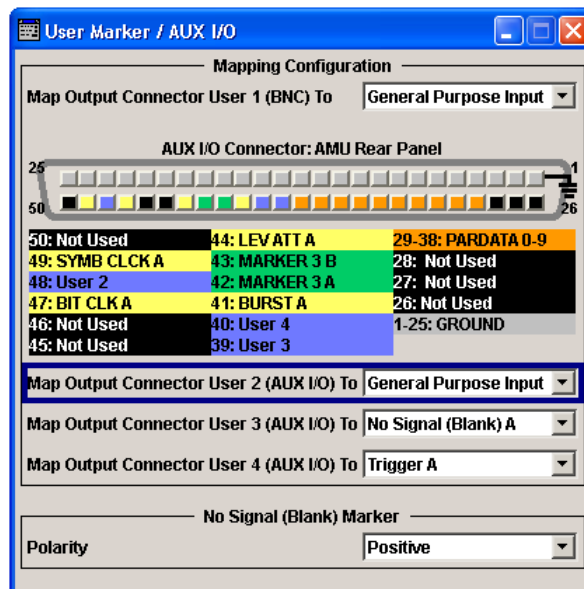
The polarity of the blank marker is selected in the "No Signal (Blank) Marker" section.



### AUX I/O Connector

An illustration of the AUX I/O interface is shown. The inputs are indicated by a "depressed" pin , outputs by a non-depressed pin .

The assignment is shown in tabular form underneath the interface. The colors indicate the signal type. A distinction is made between control signals (yellow), marker signals (green), data (orange), freely selectable signals at the user pins (blue), ground (gray), and unused pins (black).

If no path letter is specified, the pin is assigned to the signals of Path A. Pins with signals from Path B are indicated by a "B" to the right of the signal name. This does not apply to the EXT TUNE input via which the signal for external impairment of the reference frequency is supplied; this impairment signal applies to both paths.

For detailed description of the AUX I/O connector, refer to [Chapter A.2, "AUX I/O Connector"](#), on page 684.

### User Connector Signal

Selects the signal for USER interface 1 (BNC), 2, 3 or 4 (AUX I/O). The signals which are available for selection are given in [Table 5-1](#).

Remote command:

[:OUTPut:USER<ch>:SOURce](#) on page 494

### Polarity (No Signal Marker)

Selects the polarity of the No Signal Marker.

If Positive is selected, the signal is high (2.5 V) when the marker is active; if Negative is selected, the signal is low (0 V).

Remote command:

[:OUTPut:BLANk:POLarity](#) on page 494

### 5.2.3.12 Remote Channel Settings

The "Remote Channel Settings" dialog provides access to the settings for remote control. The dialog is opened using the SETUP or MENU key under "Remote".

- ▶ To access this dialog, press the SETUP or MENU key and select "Remote > GPIB,...".

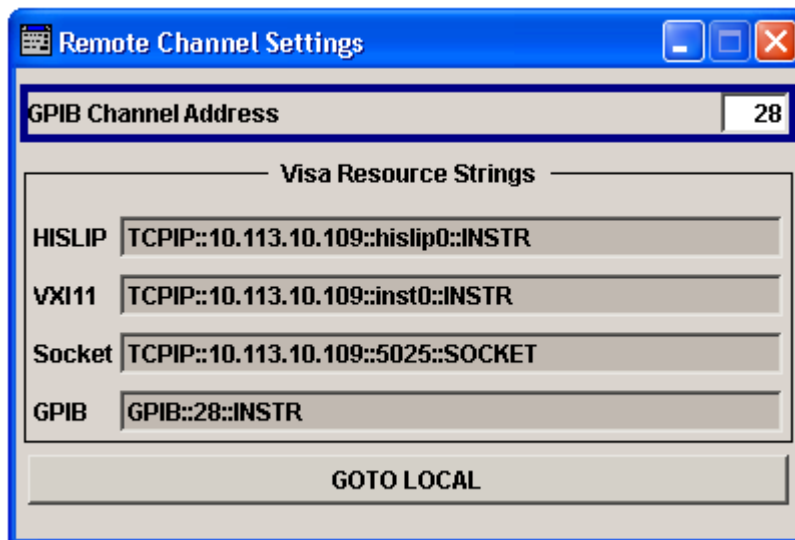

#### GPIB channel address

Sets the address of the GPIB channel the instrument is connected to.

Remote command:

`:SYSTEM:COMMunicate:GPIB[:SELF]:ADDRESS` on page 663

#### Visa Resource Strings

Displays the visa resource strings, used for remote control of the instrument. Each interface requires an individual unique address, to identify the instrument for remote control.

Remote command:

`:SYSTEM:COMMunicate:HISLip:RESOURCE?` on page 665

`:SYSTEM:COMMunicate:NETWork:RESOURCE?` on page 665

`:SYSTEM:COMMunicate:SOCKet:RESOURCE?` on page 665

`:SYSTEM:COMMunicate:GPIB:RESOURCE?` on page 664

#### Goto Local

Switches the instrument to operate in local control mode.

Switching from remote to local control mode can be also done with one of the following actions:

- manually with the LOCAL key on the front panel
- with the interface command `&GTL` via the remote control interface
- with the key combination CTRL + Q.

Remote command:  
&GTL

### 5.2.3.13 LXI Status

The "LXI - LAN eXtensions for Instruments - Status..." dialog displays the settings and status of the LAN and allows to reset the LAN connection.

For more information on LXI, see [Chapter 2.9, "LXI Configuration"](#), on page 60.

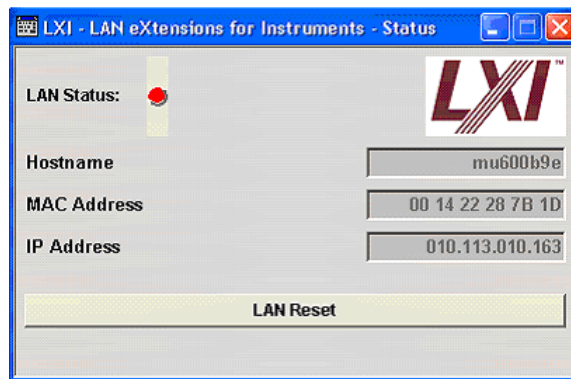

#### LAN Status

The LED indicates the LXI status.

The LAN Status is also indicated with the LED "LAN Status" on the front panel of the instrument.

"green"                    normal operation  
 "green (flashing)"        device identification  
 "red"                      LAN fault

Remote command:  
n.a.

#### LAN Reset

Initiates the network configuration reset mechanism for the instrument and resets the hostname, MAC address, and IP address.

According to the LXI standard, an LAN Reset must place the following network settings to a default state:

Parameter	Value
TCP/IP Mode	DHCP + Auto IP Address
Dynamic DNS	Enabled
ICMP Ping	Enabled
Password for LAN configuration	LxiWebIfc

The LAN Reset for the R&S AMU also resets the following parameters:

Parameter	
Hostname	Instrument-specific host name
Description	Vector Signal Generator
Negotiation	Auto Detect
VXI-11 Discovery	Enabled

The LAN settings are configured using the instrument's LXI Browser Interface described in [Chapter 2.9, "LXI Configuration"](#), on page 60.

To open the "Instrument Home Page" (welcome page), type the instrument's computer name (host name) or IP address in the address field of the browser on your PC, for example *http://10.111.10.175*.

**Note:** Do not add the missing zeros in the IP address, while opening the Instrument Home Page.

Remote command:  
n.a.

#### 5.2.3.14 Protection

This "Protection" dialog provides access to the unlocking of different protection levels. To open this dialog, use the SETUP or MENU key under "Protection".

After the instrument has been switched on, the protection levels 1 to 5 are automatically activated. To deactivate the protection, the correct password has to be entered. With the corresponding check boxes, you can activate the protection again.

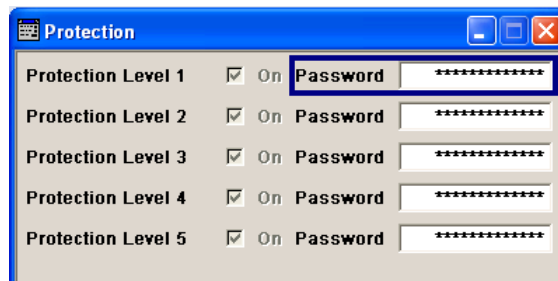

The following functions are protected in the respective levels:

- Protection Level 1  
protects against accidental changes to certain settings, such as clock and date, network settings or instrument names, etc. This level is accessible to the user.
- Protection Level 2  
provides access to the unlocking of protected service functions. It is accessible to authorized personnel of R&S Service Departments only.
- Protection Level 3-5  
are reserved for factory internal use.

### Protection Level/Password

Protection Level 1 can be activated to expand the functionality of the internal adjustment and to access the selftests.

The password is 123456.

Remote command:

:SYSTem:PROTect<ch>[:STATe] on page 666

#### 5.2.3.15 Security

The security concept of the R&S AMU helps you to protect your instrument against uncontrolled access and changes. All provided security services require that you enter the security password.

Provided security services are:

- **Password** management secures controlled user access to the instrument  
The password concept enables you to assign a security password for accessing the mass storage of the instrument.  
For more information concerning the security password, see the description *Resolving Security Issues when Working with an R&S AMU*. You can find this document on the R&S AMU product page at "Downloads" > "Manuals".
- **LAN Connections** secures controlled network access.  
Remote control via LAN interface requires that the interface is activated.
- **General** security parameters as:
  - **USB Storage** secures controlled access to the mass memory of the instrument.
  - **Annotation** frequency and amplitude prevents reading the display.



Changing the security password requires that you enter the old password, the new password and that you confirm the new password.

To assign the password, press the "Accept" button. This action can not be undone! Keep also in mind, that security settings are never reset, even if you perform a factory preset.

---

- ▶ To access this dialog, press the SETUP or MENU key and select "Protection" > "Security".

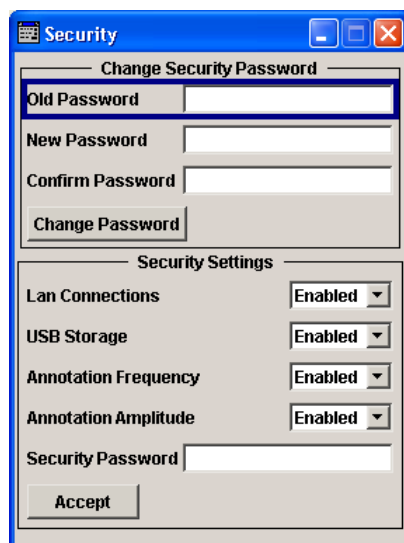

The "Security" dialog comprises the parameters for configuring the passwords, as well as the security settings of the mass storage and the LAN services.



The settings in this dialog will not be assigned until you enter the [Security Password](#) and confirm with the [Accept](#) button.

### Change Security Password

Enables you to change and confirm the security password.

#### Old Password ← Change Security Password

Enters the currently used security password. The default password is '123456'.

**Note:** It is highly recommended to change the default security password before connecting the instrument to the network.

The security password is required when changing the status of the USB and LAN interface.

#### New Password ← Change Security Password

Enters the new security password.

The security password may contain decimal characters only.

#### Confirm Password ← Change Security Password

Confirms the new password by repeating.

**Note:** The new password will not be assigned until you select the [Change Password](#) button.

#### Change Password ← Change Security Password

Changes the password accordingly.

**Note:** Keep in mind, that a changed password is never reset, even if you perform a factory preset.

**LAN Connections**

Enables the LAN interface.

It is not possible to access the instrument via LAN while the LAN connection is disabled.

**Note:** The setting will not be assigned until you enter the [Security Password](#) and confirm with [Accept](#).

**USB Storage**

Enables the USB interfaces.

The instrument does not recognize any device connected to the USB interface when the interface is disabled.

**Note:** The setting will not be assigned until you enter the [Security Password](#) and confirm with [Accept](#).

**Annotation Frequency**

Enables/disables the display of the currently used frequency in the header of the instrument.

**Note:** The setting will not be assigned until you enter the [Security Password](#) and confirm with [Accept](#).

Remote command:

`:DISPlay:ANNotation:FREQuency` on page 469

**Annotation Amplitude**

Enables/disables the display of the currently selected level in the header of the instrument.

**Note:** The setting will not be assigned until you enter the [Security Password](#) and confirm with [Accept](#).

Remote command:

`:DISPlay:ANNotation:AMPLitude` on page 468

**Security Password**

Enters the password that is required to enable or to disable the settings protected by a security password. Default is '123456'.

**Note:** It is highly recommended that you to change the default security password before connecting the instrument to the network.

All settings are only accepted after the "Accept" button is pressed.

**Accept**

Applies the modified settings, provided the security password is entered correctly.

**Note:** This action can not be undone. Keep in mind, that a changed password is never reset, even if you perform a factory preset.



### 5.2.3.16 Save/Recall

The "Save/Recall" submenu can also be called up with the FILE key and is therefore described in the section of this key (see [Chapter 5.2.8, "Storing and Loading Instrument Data - File Key"](#), on page 167).

### 5.2.3.17 Factory Preset

The "Factory Preset" dialog provides a function to reset the instrument's settings to their factory state. This function is activated by pressing the "Execute Factory Preset" button.

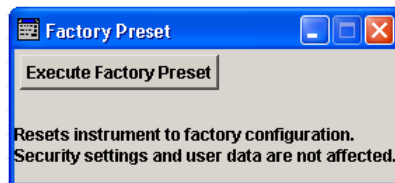

#### Factory Preset

Reset the instrument's settings to their factory state.

**Note:** Since Factory Preset resets the Remote Channel and network settings to the default values, executing Factory Preset via remote control terminates the connection to the instrument, if these settings had been configured to values different to the default ones!

The factory preset function resets nearly all instrument settings. In addition to the regular preset by means of the PRESET key, a "Factory Preset" resets also the following values:

- Reference frequency settings ("Ref Oscillator" menu)
- Power on settings ("Level/EMF" menu)
- Network settings including hostname ("Setup" menu)
- Remote Channel settings including GPIB address ("Setup" menu)
- Start/Stop Display Update ("Setup" menu)
- Display and keyboard settings ("Setup" menu).

To maintain security, password settings and all settings protected by these passwords like disabled USB and LAN connections are not changed.

Not affected by the "Factory Preset" are also user data, lists or instrument settings files, created for example by means of the Save/Recall function.

Remote command:

:SYSTem:FPReset on page 431

### 5.2.3.18 Help

The "Help" dialog offers comprehensive online help for the R&S AMU. A desired topic can be selected via the table of contents (select "Manual") or the index (select "Index").

For context-sensitive information about a marked parameter, press the HELP key. For a description of the "Help" menu, refer to the section covering the HELP key (see [Chapter 5.2.7, "Help System - Help Key"](#), on page 166).

## 5.2.4 Switching to Manual Control - Local Key

The local key switches from remote control to manual control (local state).

In remote control mode the instrument indicates the remote state in the display header. The rest of the display remains unchanged and shows the current instrument status, that means the status which exists under the remote control settings. The instrument can be operated (for example dialogs can be opened). However, it is not possible to enter or change values.

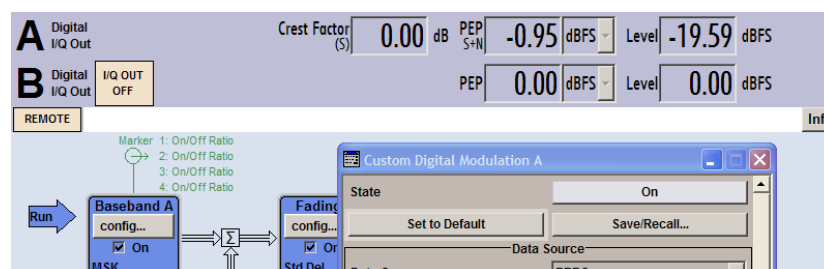

The status message additionally indicates whether the LOCAL key is disabled or enabled.

See also [Chapter 6.2.1, "Switching to Remote Control"](#), on page 389.

The following states are indicated:

- "REMOTE"  
The LOCAL key switches the instrument from remote control to manual control. The current command must be fully processed before the mode is switched, otherwise the instrument switches immediately back to remote control.
- "REM-LLO"  
The LOCAL key is locked, initiated by the `&LLO` (local lockout) command. The instrument can be switched from remote state to local state only via remote control, for example with `&GTR` or the Visual Basic command `CALL IBLOC (generator%)`. The LOCAL key has previously been locked by the remote command `&LLO`.
- The status "LOC-LLO" indicates that the instrument has been switched from remote control to manual operation. With the next activating of the remote control mode, the instrument cannot be switched to manual operation by the operator. The status information changes to "REM-LLO". The instrument can be switched to local state only via remote control, for example with the Visual Basic command `CALL IBLOC (generator%)`.

When switching from remote to manual control, the display update function is automatically deactivated ("SETUP" > "Start/Stop Display Update" > "Off").

## 5.2.5 Generating a Hard Copy of the Display

The save/recall function enables you to store the settings in a file. In addition, you can create a hard copy of the current display to save the most important settings of a performed signal generation in an image file.

### 5.2.5.1 Hard Copy Settings

- ▶ To access the dialog, press the HCOPIY key.

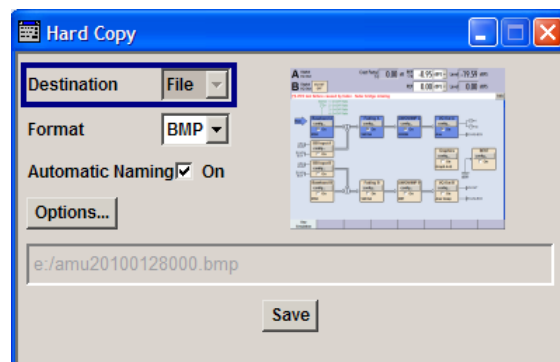

The dialog contains the parameters for configuring the output format and location of a hardcopy.

The remote commands required to define the hard copy settings are described in [Chapter 7.11, "HCOPY Subsystem"](#), on page 473.

#### Destination

Indicates that the hardcopy is stored in a file (see also ["File Options"](#) on page 164).

Remote command:

`:HCOPY:DEVIce` on page 474

#### Options

Opens the "Hardcopy Options" dialog for configuring the corresponding parameters (see ["File Options"](#) on page 164).

Remote command:

n.a.

#### File

Some configuration parameters are already offered in the Hardcopy dialog. All configuration parameters are available in ["File Options"](#) on page 164.

#### Automatic Naming

Activates automatic generation of the file name. Automatic naming is configured in the "Options..." sub dialog, see ["File Options"](#) on page 164.

Remote command:

`:HCOPY:FILE[:NAME]:AUTO:STATe` on page 479

### File Info

Indicates the file name. The file name can be entered either manually via the file manager (button "File...") or generated automatically (Automatic naming checkbox). Automatic naming is configured in the "Options..." submenu.

Remote command:

`:HCOpy:FILE[:NAME]` on page 475

`:HCOpy:FILE[:NAME]:AUTO:FILE?` on page 476

### 5.2.5.2 Hardcopy Options

This section describes the "Hardcopy Options" dialog.

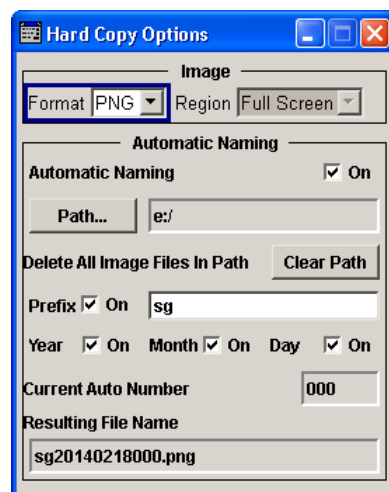

### File Options

Dialog for setting the file parameters.

"Format" Selects the output file format, for example \*.bmp, \*.jpg\*.xpm\*.png.

Remote command:

`:HCOpy:IMAGe:FORMat` on page 479

`:HCOpy:DEVIce:LANGUage` on page 474

"Region" Selects the snapshot area, either the entire screen or the currently active dialog.

Remote command:

`:HCOpy:REGIon` on page 480

"Automatic Naming" If enabled, creates the output filenames automatically according to rules following the activated components.

"Path..." Selects the directory.

**Note:** To select the destination path, you have to specify a file name as well. Otherwise an error message is displayed and the selection is canceled.

Directory, path and file name are displayed in the infoline right to the "Path" button.

Remote command:

`:HCOPY:FILE[:NAME]:AUTO:DIRectory` on page 475

`:HCOPY:FILE[:NAME]:AUTO?` on page 475

"Clear Path" Deletes all image files with extensions `bmp`, `img`, `png`, `xpm` and `csv` in the directory set for automatic naming.

Before deleting the image files a warning message is displayed requiring the confirmation.

Remote command:

`:HCOPY:FILE[:NAME]:AUTO:DIRectory:CLEar` on page 476

"Prefix, Year, Month, Day" Determines the rules for "Automatic Naming".

Per default, the automatically generated file name is composed of: `<Path>/<Prefix><YYYY><MM><DD><Number>.<Format>`, where `Y`, `M` and `D` mean Year, Month, Day; `Number` is the "Current Auto Number".

You can deactivate/activate each component separately.

The "Resulting File Name" indicates the current file name syntax.

Remote command:

`:HCOPY:FILE[:NAME]:AUTO[:FILE]:PREFix:STATe` on page 478

`:HCOPY:FILE[:NAME]:AUTO[:FILE]:PREFix` on page 478

`:HCOPY:FILE[:NAME]:AUTO[:FILE]:YEAR:STATe` on page 479

`:HCOPY:FILE[:NAME]:AUTO[:FILE]:MONTH:STATe` on page 477

`:HCOPY:FILE[:NAME]:AUTO[:FILE]:DAY:STATe` on page 477

"Current Auto Number" Indicates the number which is used in the automatically generated file name.

**Note:** When initially switching on the instrument the number is reset to the lowest possible value. Starting with number 0 the output directory is scanned for already existing files. As long as files with the same name are existing the number is increased by 1. The number is automatically set so that the resulting file name will be unique within the selected path. The current number is not in the save/recall file but will be temporarily stored within the database. At following save operations the number is increased.

Remote command:

`:HCOPY:FILE[:NAME]:AUTO[:FILE]:NUMBer?` on page 478

"Resulting File Name" Indicates the automatically generated file name.

Remote command:

`:HCOPY:FILE[:NAME]:AUTO:FILE?` on page 476

**Save**

Stores the hardcopy.

Remote command:

:HCOPY [ :EXECute ] on page 474

**5.2.6 Messages - Info Key**

The INFO key opens a window containing a detailed description of every message displayed in the info bar, see [Chapter 4.2.3, "Info Window"](#), on page 102 and [Chapter 9, "Status Information, Error Messages and Troubleshooting"](#), on page 675.

**5.2.7 Help System - Help Key**

The HELP key opens a browser window containing a context-sensitive description of the highlighted parameter.

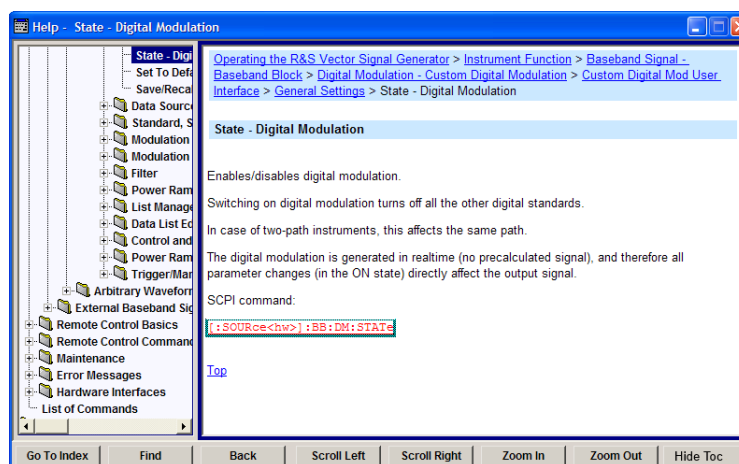

The context-sensitive page which is opened with the HELP key is part of a comprehensive help system. It is possible to move from this context-sensitive page to any page of the help system. The following navigation aids are available:

- Internal links in the text  
They open pages which are directly linked to the described function. In this way it is possible, for example, to call up the description of the GPIB command for any particular function.
- Back  
The "Back" button calls up the page last viewed.
- Contents in the navigation panel  
The contents list is used to open the individual help pages. It has a hierarchical structure. The highlighted line indicates where the currently displayed page is within the contents list.
- Index in the navigation panel  
The index is used to call up all pages which contain the selected entry. The index has an alphabetical structure and also contains all GPIB commands.

- Find  
The find function allows you to look for freely selectable terms in all help pages. A list of the pages containing the entered term is displayed as the search result. The search can be limited to words in the page title to increase the number of hits.
- To maximize the "Topics" window, you can hide the contents tree with the "Hide Contents" button, and vice versa.

The softkeys are used to determine the entry focus for front panel operation, to select the content of the navigation window and to change the font size. To determine the entry focus for front panel operation the Cursors UP/Down are used. The links are highlighted in blue, and can be selected and called up using the rotary knob.

### 5.2.8 Storing and Loading Instrument Data - File Key

The R&S AMU allows complete instrument settings to be stored in files on the hard disk.

Defined and complex instrument settings can then be reproduced at any time by loading this data. If required, these settings can be loaded to various signal generators.

The corresponding menu is available under "Save/Recall" in the "Setup" menu or accessible by means of the FILE key. The instrument settings are saved in files which can be stored in data directories.

Additionally there are intermediate memories in which the current instrument setting can be stored and then called up again by just pressing a key. This provides fast switching between different instrument settings.

Only settings which differ from the preset values and configuration data for the operating elements (e.g. window positions) are stored. As a result the files remain relatively small. Furthermore, instrument settings can easily be transferred between different equipped signal generators since the files contain only relevant information. When loaded, the referenced settings are implemented and all non-referenced parameters are set to the associated preset values.

If list data is part of the instrument settings, e.g. a list of user correction data, a reference to this list is stored, not the list itself. The list is reactivated when the associated settings are loaded, but the list may have been modified or deleted in the meantime or may not be available on a different instrument. If the list has been modified, the new entries will be used. An error message appears if an attempt is made to access a non-existing list or to activate settings which are not supported by the instrument.



- Network settings and remote settings are not saved and restored.
  - Lists are stored and loaded in the appropriate menus. For example, the GSM frame definitions are created and stored in the "GSM" menu.
- 

When loading an instrument setting, it is possible to select whether the current frequency and level setting is to be retained or whether the stored settings are to be activated. It is possible to delete stored instrument settings. A file can be copied by loading it with "Recall" and then storing it under a new name.

Settings can be transferred easily between instruments with different equipment options and/or firmware versions because only the settings which differ from the preset values are affected. When settings are loaded, only those which are possible on the instrument are implemented. Error messages indicate the settings which cannot be implemented.

The stored file is transferred from one instrument to another using the memory stick or by means of a network drive.

General file management functions such as copying and moving data are available in the "File Manager" dialog.

### 5.2.8.1 Save/Recall Menu

The settings available in the File menu "Save/Recall" depend on the operation selected under "Select Operation".



For more information, see [Chapter 4.7.1, "File Select Dialog"](#), on page 124.

#### Select Operation

Selects the file function.

Accesses the settings for storing ("Save") and loading ("Recall") of the instrument settings.

"Save..." Calls the menu for storing the current instrument setting (see [Chapter 5.2.8.2, "Storing Instrument Settings"](#), on page 168).

"Recall..." Calls the menu for calling up a stored instrument setting (see [Chapter 5.2.8.3, "Loading Instrument Settings"](#), on page 170).

### 5.2.8.2 Storing Instrument Settings

If "Save" is selected under "Select Operation", the File menu provides options for storing the current instrument setting in a file.

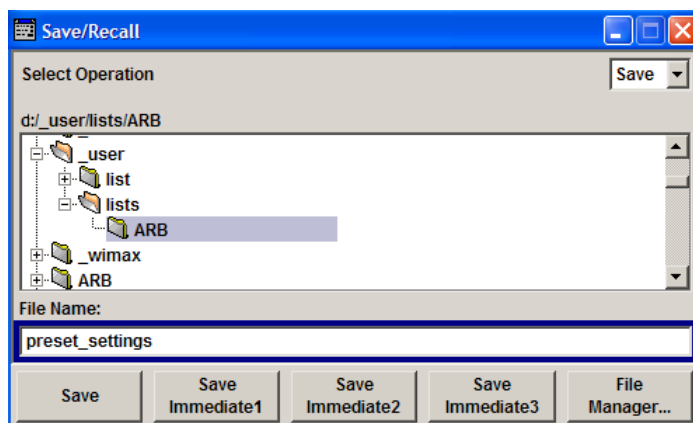



**Recent files**

Displays the files last used.

**Directory, File List and File Name****Note:**

You access this generic standard function each time you perform one of the following:

- store or load (settings) files
- define a folder these files are to be stored in or
- navigate through the file system.

The name of the dialog is context sensitive but the provided functions are self-explanatory and very similar.

With the provided settings, you can perform the following:

- to navigate through the file system, use the directory tree
- to create a new file, load and store files, use the dedicated functions "New", "Select", "Save" and [Recent files](#).
- to perform standard file management functions, like create new directories, move, copy, delete files and/or directories, use the standard "File Manager" function (see ["File Manager"](#) on page 170).

Remote command:

to list all files in a directory:

[:MMEMory:CDIRectory](#) on page 489

[:MMEMory:CATalog?](#) on page 488

refer to the description of firmware options for the syntax of the corresponding SCPI command:

```
[ :SOURce<hw> ] :BB:<Digital Standard> :SETTing:CATalog
```

to list files with user data:

[\[ :SOURce<hw> \] :BB:DM:DLISt:CATalog?](#) on page 584

[\[ :SOURce<hw> \] :BB:DM:CLISt:CATalog?](#) on page 584

**Save**

Stores the current instrument settings under the specified path.

Remote command:

[\\*SAV](#) on page 429

[:MMEMory:STORe:STATe](#) on page 493

Refer to the descriptions of the firmware options for the correct syntax of the corresponding SCPI commands:

```
[ :SOURce<hw> ] :BB:<Digital Standard> :SETTing:STORe
```

```
[ :SOURce<hw> ] :BB:<Digital Standard> :SETTing:DELeTe
```

**Fast Save**

Determines whether the instrument performs an absolute or a differential storing of the settings.

Enable this function to accelerate the saving process by saving only the settings with values different to the default ones.

**Note:** This function is not affected by the "Preset" function.

Remote command:

[ :SOURce<hw> ] :BB:DM:SETTing:STORe:FAST on page 594

[ :SOURce<hw> ] :BB:ARBitrary:MCARrier:SETTing:STORe:FAST on page 538

refer to the description of firmware options for the syntax of the corresponding SCPI commands

### Save Immediate x

Stores the current instrument setting in one of the three intermediate memories.

These instrument settings are retained until a different instrument setting is stored in the intermediate memory. When the instrument is switched off, the contents of the intermediate memories are retained.

Remote command:

\*SAV on page 429

### File Manager

Accesses the "File Manager" dialog, see [Chapter 5.2.8.5, "File Manager"](#), on page 174.

Remote command:

n.a.

## 5.2.8.3 Loading Instrument Settings

If "Recall" is selected under "Select Operation", the "File" menu provides options for loading complete instrument settings. Here it is possible to select whether the current or stored frequency and level settings are to be used.

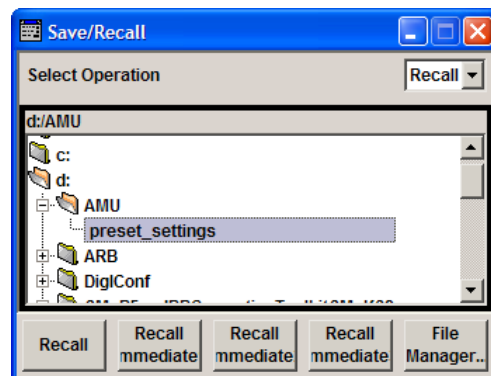

### Recent files

Displays the files last used.

### Directory, File List and File Name

#### Note:

You access this generic standard function each time you perform one of the following:

- store or load (settings) files
- define a folder these files are to be stored in or
- navigate through the file system.

The name of the dialog is context sensitive but the provided functions are self-explanatory and very similar.

With the provided settings, you can perform the following:

- to navigate through the file system, use the directory tree
- to create a new file, load and store files, use the dedicated functions "New", "Select", "Save" and [Recent files](#).
- to perform standard file management functions, like create new directories, move, copy, delete files and/or directories, use the standard "File Manager" function (see ["File Manager"](#) on page 170).

Remote command:

to list all files in a directory:

[:MMEMory:CDIRectory](#) on page 489

[:MMEMory:CATalog?](#) on page 488

refer to the description of firmware options for the syntax of the corresponding SCPI command:

```
[ :SOURce<hw> ] :BB :<Digital Standard> :SETTing :CATalog
```

to list files with user data:

[\[ :SOURce<hw> \] :BB :DM :DLISt :CATalog?](#) on page 584

[\[ :SOURce<hw> \] :BB :DM :CLISt :CATalog?](#) on page 584

### Recall

Load the selected configuration.

If an instrument setting in which a sweep was activated is stored, the sweep is started when the recall command is called.

If an instrument setting which accesses lists is stored, this list is also loaded.

If the list has been deleted in the meantime, an error message appears when the instrument setting is loaded. If the list has been overwritten in the meantime, the new entries will be used.

Remote command:

[:MMEMory:LOAD:STATe](#) on page 492

[\\*RCL](#) on page 428

Refer to the descriptions of the firmware options for the correct syntax of the corresponding SCPI command:

```
[ :SOURce<hw> ] :BB :<Digital Standard> :SETTing :LOAD
```

### Recall Immediate x

Loads the selected configuration from one of the three intermediate memories.

If an instrument setting in which a sweep was activated is stored, the sweep is started when the recall command is called.

If an instrument setting which accesses lists is stored, this list is also loaded.

If the list has been deleted in the meantime, an error message appears when the instrument setting is loaded. If the list has been overwritten in the meantime, the new entries will be used.

A message appears if no instrument configuration is stored in this memory.

Remote command:

[\\*RCL](#) on page 428

**File Manager**

Accesses the "File Manager" dialog, see [Chapter 5.2.8.5, "File Manager"](#), on page 174.

Remote command:  
n.a.

**5.2.8.4 File Select Dialog**

The "File Select" dialog opens automatically each time you select a data list file as data source or you select a control list.

**To access a loadable data list file**

1. Select the "Data List Name" in the individual dialog, e.g. for "Baseband > 3GPP FDD > Basestations > BS1 > Channel Table > P-CCPCH > Data = Data List" select "DList = None".

A "File Select" dialog for loading, creating and modifying a file is displayed.

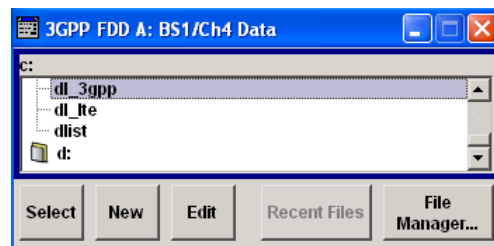

**Tip:** The name of the dialog is context sensitive and differs depending on the particular function this dialog is from. However, the provided functions are very similar.

2. To load an existing file, navigate through the file system, select the file and confirm with "Select".
3. To create a new file, for example if there is no data list file specified, navigate through the file system to the desired folder, select "New" and specify the file name.

A new empty file is created and stored in the selected folder.

4. To edit an existing or newly created file, navigate through the file system, select the file and select "Edit".

The standard "Data List Editor" dialog opens, see ["Data List Editor"](#) on page 281.

5. Edit the file content and confirm with "Save".

**Directory, File List and File Name****Note:**

You access this generic standard function each time you perform one of the following:

- store or load (settings) files
- define a folder these files are to be stored in or
- navigate through the file system.

The name of the dialog is context sensitive but the provided functions are self-explanatory and very similar.

With the provided settings, you can perform the following:

- to navigate through the file system, use the directory tree
- to create a new file, load and store files, use the dedicated functions "New", "Select", "Save" and [Recent files](#).
- to perform standard file management functions, like create new directories, move, copy, delete files and/or directories, use the standard "File Manager" function (see ["File Manager"](#) on page 170).

Remote command:

to list all files in a directory:

[:MMEMory:CDIRectory](#) on page 489

[:MMEMory:CATalog?](#) on page 488

refer to the description of firmware options for the syntax of the corresponding SCPI command:

```
[ :SOURce<hw> ] :BB :<Digital Standard> :SETTing :CATalog
```

to list files with user data:

[\[ :SOURce<hw> \] :BB :DM :DLISt :CATalog?](#) on page 584

[\[ :SOURce<hw> \] :BB :DM :CLISt :CATalog?](#) on page 584

### Functions for handling of data lists

Provided are the following standard functions for file handling:

"Select"            Select and load the file.

Remote command:

[\[ :SOURce<hw> \] :BB :DM :DLISt :SElect](#) on page 590

Refer to the descriptions of the firmware options for the correct syntax of the corresponding SCPI command:

```
[ :SOURce<hw> ] :BB :<Digital Standard> :... :DATA DLISt
```

```
[ :SOURce<hw> ] :BB :<Digital Standard> :... :DSElect
```

"New"                Creates new file with the specified "File Name".  
To confirm, select "OK"; use "Cancel" to undo the operation.  
To edit the file content, select "File Select > Edit".

"Edit"                Accesses the "Data List Editor" and loads the selected file for editing,  
see ["Data List Editor"](#) on page 281.

### Functions for handling of control lists

Provided are the following standard functions for file handling:

"Select"            Select and load the file.

Remote command:

[\[ :SOURce<hw> \] :BB :DM :CLISt :SElect](#) on page 587

"New"                Creates new file with the specified name. To edit the file content,  
select "File Select > Edit".

"Edit"                Access the "Control List Editor" and loads the selected file for editing,  
see ["Control and Marker List Editor"](#) on page 283.

**Recent files**

Displays the files last used.

**File Manager**

Accesses the "File Manager" dialog, see [Chapter 5.2.8.5, "File Manager"](#), on page 174.

Remote command:

n.a.

**5.2.8.5 File Manager**

The "File Manager" is a tool very similar to a standard Windows Explorer and helps you manage mass storage media and files stored on the R&S AMU.

You can perform the following tasks:

- Copying multiple files from disk to other media and vice versa, see [Chapter 5.2.8.6, "Accessing the File System of the Instrument and Transferring Files from and to the Instrument"](#), on page 176
- Copying files into another directory, see [Copy](#) and [Paste](#)
- Renaming and deleting files, see [Rename](#) and [Delete](#)
- Creating new directories on the following drives:
  - hard disk
  - memory stick
  - network drives

See [Create New Directory](#)

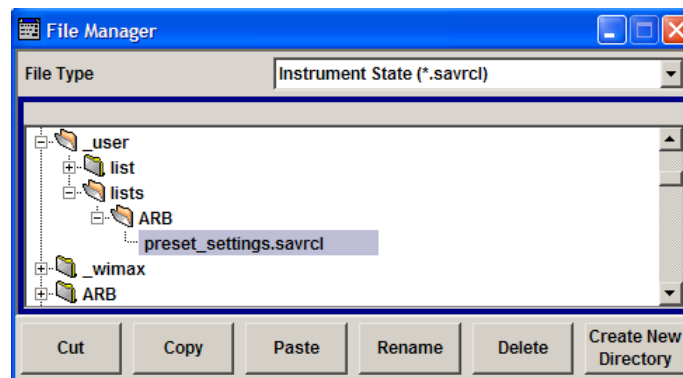

For more information, see [Chapter 4.7.2, "File Manager"](#), on page 126.

**File Type**

Selects the file type to be listed. If you select a file type with a specific file extension, only files with this extension are listed in the directory.

Remote command:

n.a.

**Directory and File Name**

Selects the directory in which the file to be deleted or copied is located. The dialog lists all files in this directory. Selected files are highlighted. The path is indicated above the directory window.

Unlike the "Save/Recall" and "File Select" dialogs, the "File Manager" displays the full file names including extensions.

Remote command:

[:MMEMory:CDIRectory](#) on page 489

**Cut**

Cuts the selected file. It can be pasted into a different directory using the "Paste" button.

Remote command:

[:MMEMory:DELeTe](#) on page 491

**Copy**

Copies the selected file. It can be pasted into a different or the same directory using the "Paste" button. When pasting the file into the same directory file name Copy of <file name> is given automatically. When pasting the file into a different directory, the original file name is kept.

Remote command:

[:MMEMory:COpy](#) on page 489

**Paste**

Pastes the file that has been copied or cut before.

Remote command:

n.a.

**Rename**

Renames the selected file or directory. The new name can be entered in the "New File-name" dialog.

Remote command:

[:MMEMory:MOVE](#) on page 492

**Delete**

Deletes the selected file. Before the file is deleted, a message appears prompting the user to confirm deletion of the file.

Remote command:

[:MMEMory:DELeTe](#) on page 491

**Create New Directory**

Creates a new directory. The name of the new directory can be entered in the "New Directory" dialog.

**Note:** When the subdirectory is entered, it is possible to enter an absolute path name (e.g. D:\user\MEAS) or the path relative to the current directory (e.g. ../MEAS).

The directory is created as a subdirectory in the selected level.

Remote command:

[:MMEMory:MDIRectory](#) on page 492

### 5.2.8.6 Accessing the File System of the Instrument and Transferring Files from and to the Instrument

To access files and the file system of the instrument or to use the general file management functions such as copying and moving data, use the standard "File Manager" dialog.

To transfer files from and to the instruments or to exchange files, use one of the following alternatives:

- Connect a memory stick to one of the USB interfaces.  
The instrument recognizes automatically a connected memory stick.
- Connect the instrument to a LAN.  
For information on how to set up a LAN connection, refer to [Chapter 2.6, "Setting Up a Network \(LAN\) Connection"](#), on page 43  
An instrument connected to a LAN supports the standard file transfer methods from a remote client:
  - File sharing according to the SAMBA/SMB (server message block) protocol see ["To access the file system of the R&S AMU via SMB \(Samba\)"](#) on page 176

This section provides an introduction to this topic. For comprehensive information, refer to the Application Note 1GP72 "Connectivity of Rohde&Schwarz Signal Generators".

#### To access the file system of the R&S AMU via SMB (Samba)

The SMB (Samba) protocol is an alternative way to access the file system of the instrument from a remote PC, if both the instrument and the PC are connected to a LAN.

1. Connect the instrument and the remote PC to a LAN.
2. Share the top instrument's folder you will access from the connected PC:
  - a) Connect a mouse to the instrument.
  - b) On the instrument, select the Windows Icon, open the context menu and select "Open Windows Explorer".
  - c) Select the folder to be shared, open the context menu and select "Share with > Advanced Sharing > Share this Folder".
  - d) Write down the shared folder name, e.g. *Data*.
3. Find out the "IP Address" of the instrument:
  - a) Select "Setup > Environment > Network Settings".
  - b) Write down the "IP Address" of the instrument, e.g. *10.113.10.105*.
4. On the remote PC, start the Windows Explorer and open the "Map Network Drive" dialog.
  - a) Select a valid "Drive", e.g. *W*.



b) In the "Folder" field, enter:

`///<"IP Address" of the Instrument>/share or`

`///<"Hostname" of the Instrument>/share, e.g. ///10.113.10.105/share`

c) Select "Finish".

A log on dialog opens and requests an user name and a password.

5. Enter the user name and the password of your instrument.

The default user name and password is *instrument*.

**Tip:** Default password. The SAMBA/SMB file access use the user *instrument* with default password *instrument*.

It is highly recommended that you change the user password in the "Security" dialog before connecting the instrument to the network!

See [Chapter 5.2.3.15, "Security"](#), on page 158.

The `Data` directory of the instrument is mapped to and displayed as a network drive of the remote PC.

You can access the files in this directory, perform standard function like creating directory, storing files, etc.

## 5.3 Graphical Display - Graphics

The R&S AMU can be used to graphically display the generated baseband signal. A selection of different signal displays assists the user in assessing and checking the increasingly complex modulation signals.

Most graphical displays are possible both for internally generated and externally applied baseband signals.



The Graphics function block is available for instruments with the option:

- R&S AMU-B13 (Baseband Main Module) and one of the options R&S AMU-B9/B10/B11 (UniCod + ARB)
- R&S AMU-B17 (Baseband input)
- R&S AMU-B62 (Noise Generator)

It is the baseband signal actually generated that is recorded and displayed, and not a signal calculated on the basis of the set parameters.

This graphical display allows the user to quickly view and check the current signal characteristics and also gives an overview of the changes in the signal over time. The signal quality can be permanently monitored. The results of parameter changes on the signal, such as a change in modulation mode, or the effects of certain configurations, e.g. the activation of several base stations in the case of (W)CDMA signals, can be analyzed directly in the display. Freezing the signal and then zooming permit a detailed

evaluation of any signal segment. The definition and display of one or more reference curves makes it possible to compare various signals (i.e. by comparing the CCDF (Complementary Cumulative Distribution Function) with different channelization codes, or the spectra if different filter parameters are selected).

An externally applied signal can be checked with respect to the anticipated signal characteristics.

The displayed signal segment can be influenced by selecting the trigger that defines the time for recording to start. With automatic triggering, the signal is tapped at the point in the signal path that is best for the respective display. The displayed signal segment is selected internally depending on the signal such that the signal characteristics of interest (e.g. the useful signal) are displayed. This selection is appropriate for a representative display of the complete signal.

In addition, a user-definable trigger is available with which the displayed signal segment can be limited.

The time resolution can be set either automatically or manually, whereby for manual setting the bandwidth for which the trace is to be displayed is selected. The transient recorders used for signal recording have a variable recording depth which is specified under the respective display.

In addition to the large graphics window, the display can also be shown in a small window ("smart graphics"). This window is fitted into the block diagram as a block, and can be used for basic checking purposes (e.g. whether the signal is still being generated).

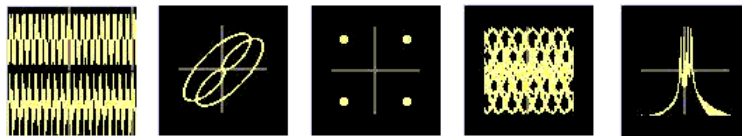

In the case of two-path instruments, the baseband signals of both paths can be displayed simultaneously.

### 5.3.1 Graphics Settings Menu

The "Graphics Settings" menu for selecting the graphical display of the output signal is opened either in the "Graphics" function block or in the menu with the same name which is opened using the MENU key.

The signal display can be selected and activated in the menu.

With two-path instruments, the settings for the two paths can be entered separately. The signals can be displayed simultaneously in two separate windows.

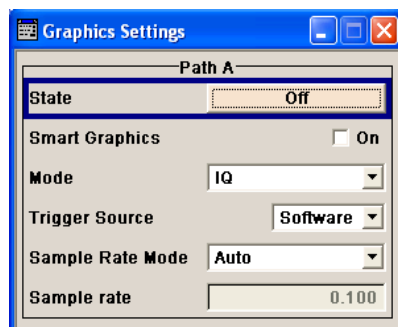

### State

Activates the selected graphical display.

After activation, the diagram selected with "Mode" is displayed in the block diagram.

At the bottom of each graphics window there are several buttons for freezing and zooming the display and for activating a reference curve.

For more information, see [Chapter 5.3.2, "Bar of Graphics Window"](#), on page 181.

Remote command:

`[ :SOURce<hw> ] :BB:GRAPhics:STATe` on page 597

### Smart Graphics

Activates the "smart graphics".

The graphic is displayed in a small window which is roughly the size of a block. These windows are displayed permanently in the block diagram until they are deactivated, and allow basic checking of the signal. They do not contain any buttons.

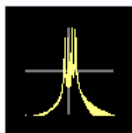

Remote command:

`[ :SOURce<hw> ] :BB:GRAPhics:SMARt:STATe` on page 596

### Mode

Selects the graphical signal display. The display is not shown until it has been activated with "Status On".

The individual signal displays are described in the [Chapter 5.3.3, "Signal Displays"](#), on page 183.

Remote command:

`[ :SOURce<hw> ] :BB:GRAPhics:MODE` on page 595

### Trigger Source

Defines the trigger for the starting time of the graphic recording.

"Software" Recording of signals is started automatically in specified intervals. This asynchronous method is appropriate when a representative display of the complete signal is desired, as recording starts in a random time reference to the signal.

"Marker 1" The starting point for recording signals is determined by marker 1 in the menu of the active standard.  
This synchronous method is appropriate when specific signal segments are to be shown in greater detail. With periodic signals, a static image is obtained by selecting a period length of marker 1 that is equal to the signal period.  
The displayed signal segment can be shifted as needed by entering a marker delay in the Trigger/Marker menu of the active standard.

Remote command:

`[ :SOURce<hw> ] :BB:GRAPhics:TRIGger:SOURce` on page 597

### Scrambling Code

(only if Code Domain (3GPP FDD DL) is selected)

Sets the scrambling code if the "Code Domain" display is selected. Since it is possible to select a different scrambling code in the menu for each of the 4 base stations and it is also possible to display an external signal, the scrambling code for which the display is to be generated must be explicitly specified here.

Remote command:

n.a.

### Sample Rate Mode

Sets how the time resolution of the signal is determined. Maximum resolution corresponds to a display covering the entire signal bandwidth. The higher the resolution is, the shorter the length of the displayed signal segment will be for the specified recording depth.

"Auto"	The resolution is set to an optimum value on the basis of the signal and display type.
"Full Bandwidth"	The resolution is set such that the display covers the entire signal bandwidth.
"User"	Under "Graphics Sample Rate", the user can determine the resolution by setting the signal bandwidth for which the display is to be generated.

Remote command:

`[ :SOURce<hw> ] :BB:GRAPhics:SRATe:MODE` on page 596

### Graphics Sample Rate

With "Auto" and "Full Bandwidth":

Displays the signal bandwidth for which the display is to be generated.

With "User":

Selects the signal bandwidth for which the display is to be generated. The setting range moves between the minimum and maximum bandwidth which is possible for the selected display. The selection is made graphically by moving the pointer.

Remote command:

`[ :SOURce<hw> ] :BB:GRAPhics:SRATe:USER` on page 597

### 5.3.2 Bar of Graphics Window

At the bottom of each graphics window there are buttons for freezing and zooming the display and for defining and activating a reference curve.



#### Run

Freezes the current display.

Clicking the button again reactivates the normal, permanently updated display.

Freezing the display allows it to be analyzed more easily. Zooming the display at the same time permits detailed evaluation of any signal segment.

Remote command:

n.a.

#### Zoom In (only possible with mouse)

The mouse can be used to freely select any section to be zoomed. This section is selected by pressing the left-hand mouse key and dragging a rectangular marquee. In this way a display can be zoomed in several steps. The zoom is cancelled by clicking the "Zoom Out" button.

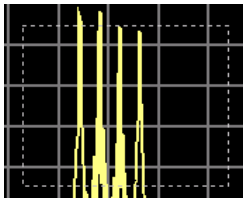

Remote command:

n.a.

#### Zoom out

Cancels the zoom.

Remote command:

n.a.

#### Time

(I/Q mode only)

Switches to seconds for time representation on the X axis of the I/Q diagram.

Remote command:

n.a.

#### Show ref

Displays the reference curve(s). All defined reference curves are displayed simultaneously (see the description of the "Copy to ref" button).

The reference curves are displayed together with the current signal. They allow visual comparison of two or more signals with different settings, e.g. with different filters.

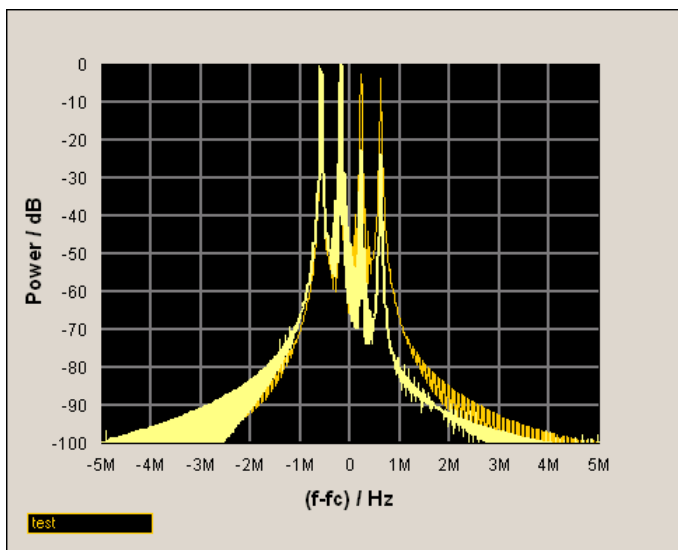

Clicking the button again hides the reference curves.

The reference curves must be defined beforehand using the "Copy to Ref" button.

Remote command:

n.a.

**Copy to ref**

Defines the current curve as the reference curve.

A window opens in which the curve can be given a comment and a color.

First of all the desired color is highlighted in the top window. If this color has already been assigned to a reference curve, this curve is overwritten. The command is entered in the bottom "Comment" section. This comment then appears next to the highlighted color.

Up to 5 reference curves can be defined and displayed simultaneously in different colors together with the current signal.

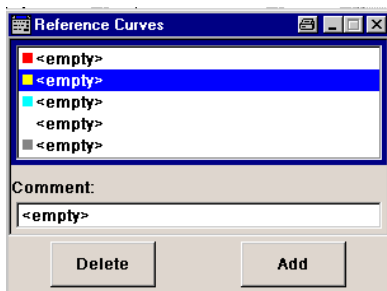

Each reference curve is available until it is deleted.

"Display area" The comments entered for the defined reference curve are shown in the display area next the assigned color. A maximum of five colors (and reference curves) are available. If no reference curve is assigned to a particular color, the comment <empty> is displayed.

"Comment"	Enters a comment for the current curve which is to be defined as the reference curve. This comment then appears next to the highlighted color in the display area.
"Delete"	Deletes the curve highlighted in the display area. Curves which are no longer required can be deleted to reduce the number of reference curves displayed simultaneously.
"Assign"	Defines the current curve as the reference curve. The new reference curve is shown together with the entered comment next to the selected color in the display area.
Remote command:	n.a.

### 5.3.3 Signal Displays

All signal displays which are used for analyzing a baseband signal can be selected. A number of signal displays are only available if the corresponding signal is generated, e.g. Code Domain only available for (W)CDMA signals.

#### 5.3.3.1 I/Q Diagram

The I/Q diagram displays the inphase component ( $i[t]$ ) and quadrature component ( $q[t]$ ) of the I/Q signal over time.

The diagram is displayed in a window with two separate coordinate systems. The coordinate systems have identical X and Y axes. The time (in number of symbols, chips or samples depending on the signal) is plotted on the X axes, and the amplitude scaled to the peak envelope power (PEP) is plotted on the Y axes (minimum scaled amplitude = -1; maximum scaled amplitude = +1). The recording depth is 1 kSamples.

This signal is picked off at the output of the baseband main module ("Impairment" function block), i.e. contained in the displayed signal is:

- impairment of the signal as defined by the user and the addition of noise.
- Fading of the signal as defined by the user
- an added external (Baseband Input)
- an added internal signal (from the second path).

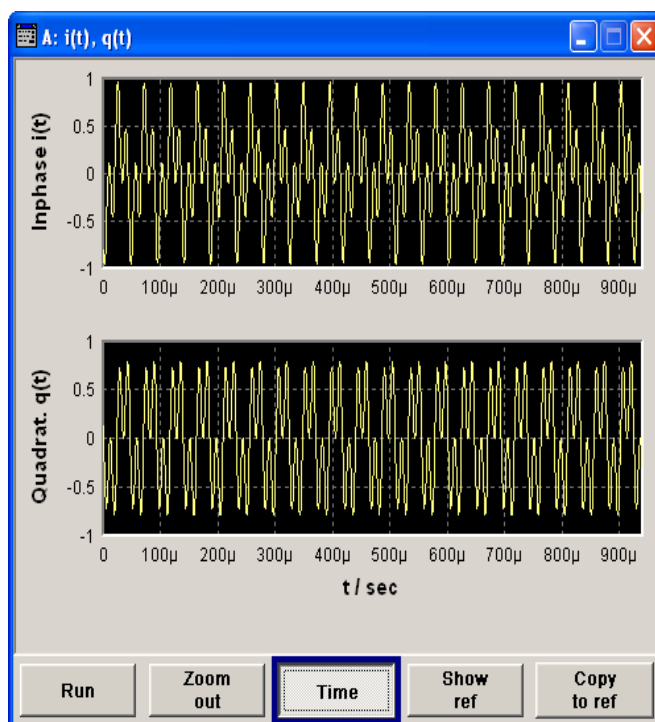

### 5.3.3.2 Vector Diagram

The Q component is displayed over the I component in the vector diagram. Each point is determined by a vector. The amplitudes of the signal components scaled to the peak envelope power (PEP) are plotted on the X and Y axis (minimum scaled amplitude = -1; maximum scaled amplitude = +1).

This display shows the curves between the various states of modulation mapping. The recording depth is 1 kSamples.

This signal is picked off at the output of the baseband main module ("Impairment" function block), i.e. contained in the displayed signal is:

- impairment of the signal as defined by the user and the addition of noise.
- Fading of the signal as defined by the user
- an added external (Baseband Input)
- an added internal signal (from the second path).



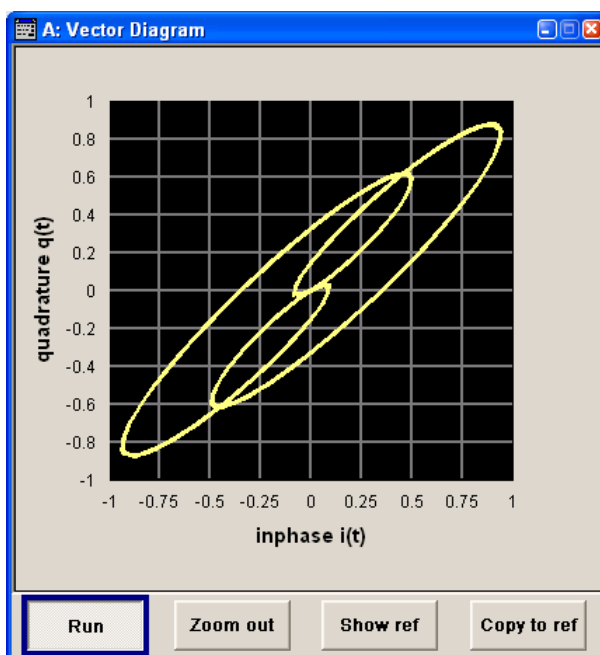

### 5.3.3.3 Constellation Diagram

In the constellation diagram, the Q component is also displayed over the I component. However, only the values at the constellation points (signal value at the ideal scanning instant of the symbol) are displayed, i.e. for each symbol only 1 value in the form of a circle is shown for the I and Q component.

The amplitudes of the signal components scaled to the peak envelope power (PEP) are plotted on the X and Y axis (minimum scaled amplitude = -1; maximum scaled amplitude = +1). The recording depth is 2kSamples.

This signal is picked off at the output of the baseband main module ("Impairment" function block), i.e. contained in the displayed signal is:

- impairment of the signal as defined by the user and the addition of noise.
- Fading of the signal as defined by the user
- an added external (Baseband Input)
- an added internal signal (from the second path).

This display shows the various states of modulation mapping which occur in the signal. The example shows the constellation diagram of a QPSK modulation signal.

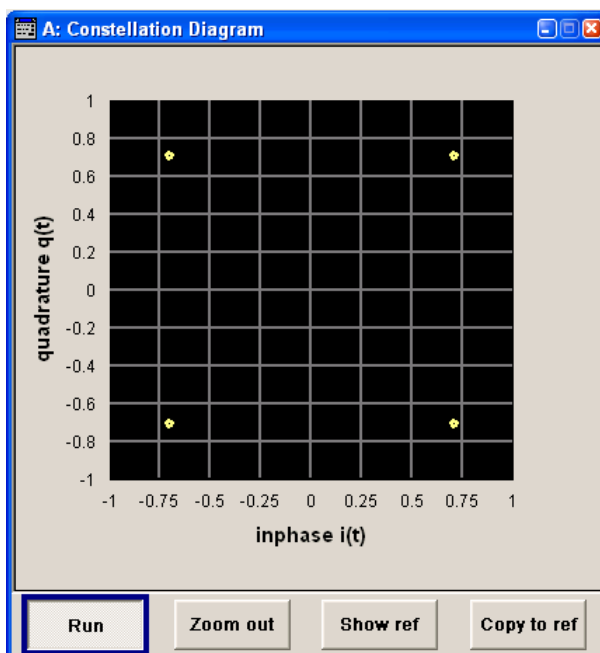

#### 5.3.3.4 Eye Diagram

The eye diagram displays synchronized and superimposed sections of either the inphase or quadrature components of the signal.

The display width (eye length) is set at 2 symbols; several hundred curve segments are superimposed. The time (in the range  $\pm 1$  symbol) is plotted on the X axis, and the amplitude scaled to the peak envelope power (PEP) is plotted on the Y axis (minimum scaled amplitude = -1; maximum scaled amplitude = +1). The beginning of recording is synchronous to the symbol and chip clock pulse. The recording depth is 2kSamples.

This signal is picked off at the output of the baseband main module ("Impairment" function block), i.e. contained in the displayed signal is:

- impairment of the signal as defined by the user and the addition of noise.
- Fading of the signal as defined by the user
- an added external (Baseband Input)
- an added internal signal (from the second path).

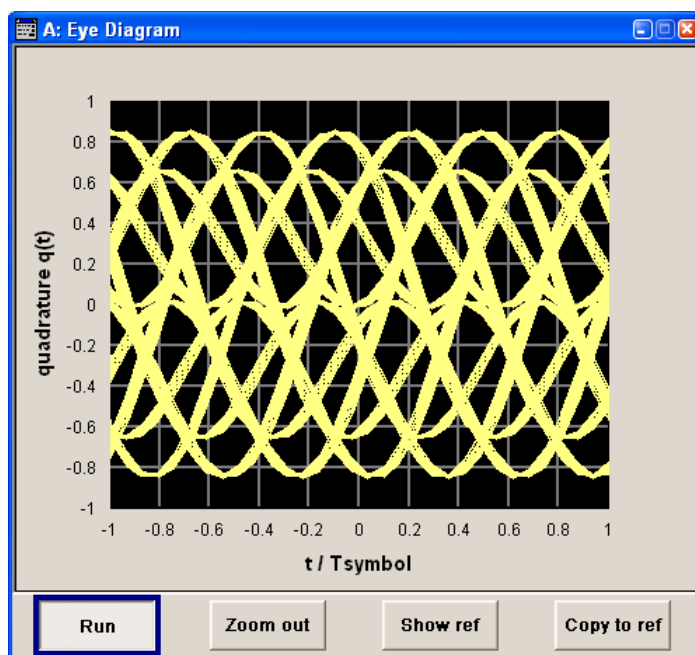

### 5.3.3.5 CCDF Display

The **Complementary Cumulative Distribution Function** shows the probability with which the output signal will exceed the average power.

The level over the average power is plotted from 0 to 20 dB on the X axis; the average power (RMS) corresponds to the origin. The probability of exceeding the average power is plotted between 0.0001% and 100% on the Y axis. The recording depth is 8kSamples.

This signal is picked off at the output of the baseband main module ("Impairment" function block), i.e. contained in the displayed signal is:

- impairment of the signal as defined by the user and the addition of noise.
- Fading of the signal as defined by the user
- an added external (Baseband Input)
- an added internal signal (from the second path).

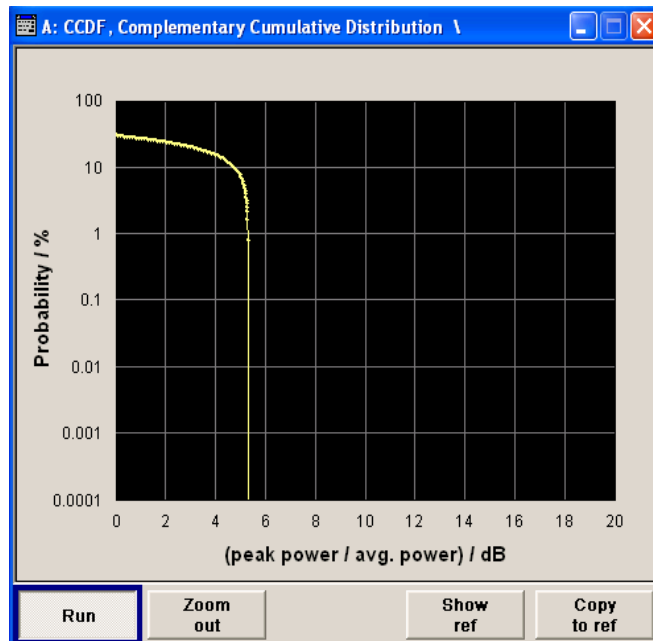

### 5.3.3.6 Power Spectrum

With the spectrum display, the signal spectrum is calculated from the I/Q signal by means of Fast Fourier Transform (FFT).

The power density over frequency is displayed. The power density is plotted on the Y axis, and the frequency is plotted symmetrically on the X axis (-sampling rate/2 to +sampling rate/2). FFT Points indicates the number of I/Q value pairs which are used for calculating a (part-)FFT. AVG indicates the number of subspectra used for averaging. The recording depth is 8kSamples.

This signal is picked off at the output of the baseband main module ("Impairment" function block), i.e. contained in the displayed signal is:

- impairment of the signal as defined by the user and the addition of noise.
- Fading of the signal as defined by the user
- an added external (Baseband Input)
- an added internal signal (from the second path).

The spectrum display of the output signal is particularly suitable for checking multi carrier signals.

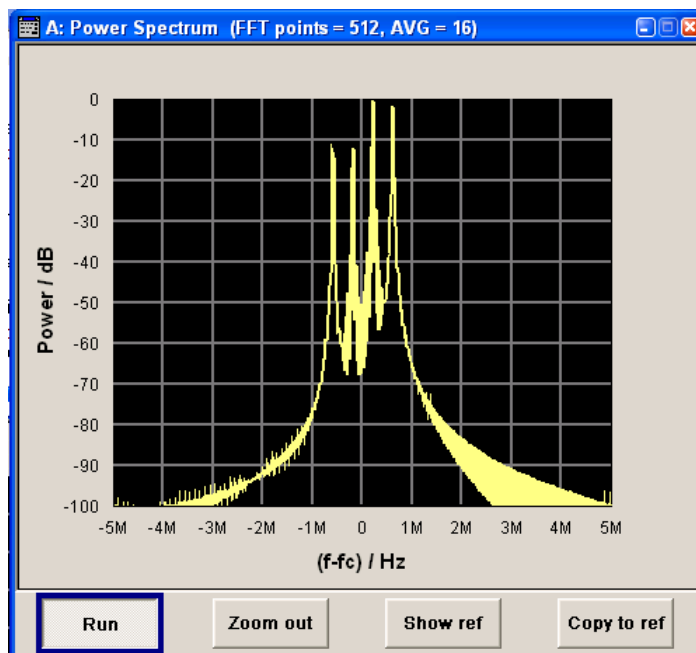

## 5.4 Bit and Block Error Rate Measurements - BERT Block

The R&S AMU contains an integrated bit error rate tester which makes it possible to evaluate a signal demodulated and decoded by a DUT by measuring the bit error rate. A known PRBS-modulated data sequence (PRBS = **p**seudo **r**andom **b**inary **s**equence) is sent to the DUT. The PRBS data sequence is decoded by the DUT and sent to the R&S AMU in the form of clock and data signals. The bit error rate tester of the R&S AMU synchronizes to the known PRBS sequence and counts the bit errors. The quotient obtained by dividing the number of error bits by the total number of bits is the BER.

In addition, a block error rate measurement can be used to verify CRC checksums. The ratio of errored blocks to total blocks yields the block error rate.

The settings are shown in the block diagram in the "BERT" function block and in the menu of the same name that is accessed via the MENU button.

The equipment layout for the basic unit (option R&S AMU-B9/B10/B11) includes the option R&S AMU-K80 (Bit Error Rate Tester).

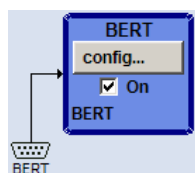

The "BERT" interface is located on the rear panel. Besides the data and clock input, it provides further inputs for masking data containing the PRBS sequence. The interface description can be found in [Chapter A.4, "BERT Connector"](#), on page 686.

### 5.4.1 Test setup

The following figure shows the test setup for the bit/block error rate measurement. The data used to drive the DUT can be generated by the R&S AMU or an user-defined external source. The R&S AMU can generate any externally computed modulation signals that were created using e.g. R&S WinIQSIM2 software (see [Chapter 5.7.4.2, "ARB User Interface"](#), on page 302).

A known PRBS sequence must be used for the bit error rate measurement.

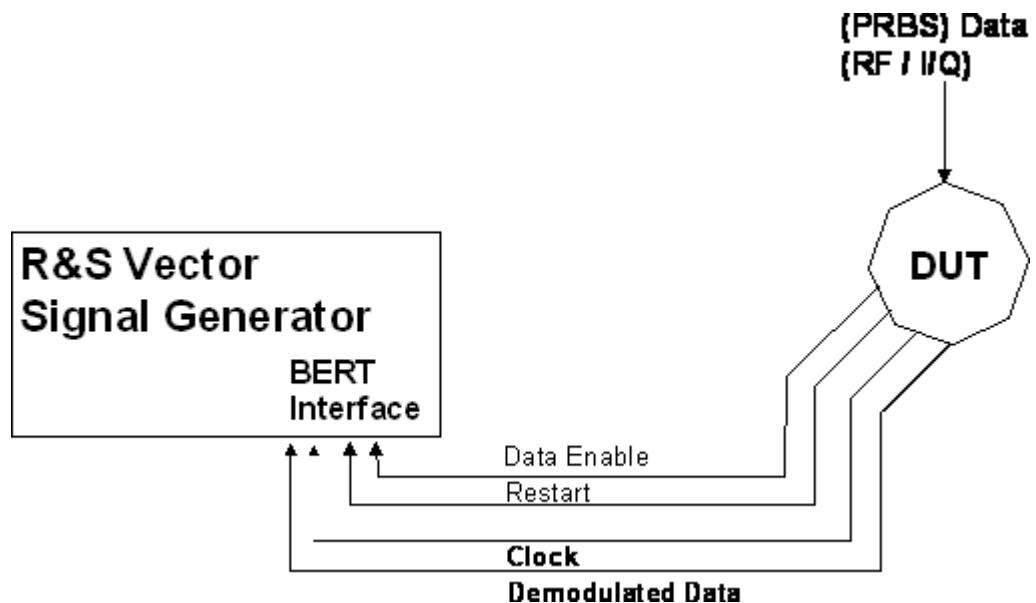

Figure 5-4: Test setup for bit or block error rate measurement.

The DUT is driven using a known data sequence. It demodulates the data and sends it together with a clock signal to the R&S AMU. The Data Enable signal marks the user data of the signal. The restart signal for restarting the PRBS calculation is only important for the bit error rate measurement.

### 5.4.2 PRBS data

To be able to detect faulty bits by a BER measurement, the data generation polynomial must be known. PRBS sequences are therefore used as the method for computing the data (see [Chapter 5.7.2.1, "Internal PRBS Data and Data Patterns"](#), on page 243). These quasi-random bit sequences are repeated periodically, depending on the polynomial selected. A randomly selected initial status yields exactly one subsequent status. The initial status and therefore the subsequent status occur only once in the whole sequence.

Hence an advantage of the PRBS data is that the bit error detector must know only the polynomial but not the entire sequence. At the start of a measurement, the feedback shift register is filled once with the applied data sequence (which corresponds to the synchronization time) and is subsequently switched from "fill" to "feedback". This creates a defined initial status and generates exactly the same data that the applied data

stream should have. Faulty bits can thus be identified and counted by comparing the received data with the results obtained from the shift register.

Creating a defined initial status makes it possible to start the analysis anywhere in the bit stream, i.e. the bit-stream source and the analyzer need not be synchronized. Delays of the DUT and transmission over long air paths, where the transmitter and the receiver are located at separate sites, therefore do not present a problem.

### 5.4.3 CRC polynomial

In the block error rate measurement, the checksum (CRC) that contains the data signal fed to the DUT is compared with the checksum that the block error rate tester calculates from the feedback data. If the two checksums differ, a block error is counted. The quotient obtained by dividing the number of faulty blocks by the total number of blocks is the block error rate.

At the beginning of the data, the shift register is initialized with 0. All user data bits are then shifted through the shift register. The CRC component is then read into a second register and compared bit by bit with the result of the calculation.

CCITT CRC 16 :  $G(x) = x^{16} + x^{12} + x^5 + x^1$  is the CRC polynomial supported.

The user data is marked by a signal that comes from the DUT and is fed to the "Data Enable" input of the BERT interface.

### 5.4.4 Clock signal

Usually the clock signal is provided by the DUT. If not, the bit clock can be extracted from the CLOCK output connector (only with "Custom Dig Mod" signals in realtime). If signals complying with other digital standards are generated or if ARB waveforms are used, a marker signal can be used as a clock. As the DUT causes a delay, the ratio of clock-to-data travel times must always be taken into account and checked with an oscilloscope if necessary. The R&S AMU indicates the status of the clock and data lines and of the synchronization in the menus.

### 5.4.5 Ending the measurement

The measurement results usually lie in the range of  $10^{-2}$  to  $10^{-9}$  for the bit error rate, and in the range of  $10^{-2}$  to  $10^{-4}$  for the block error rate. This means that a very large number of bits or blocks may have to be tested before a faulty bit or block occurs. Because of the large number of bits/blocks involved, the measurement time is usually very long. Since 32-bit-wide counters are used for the total number of bits/blocks and the number of error bits, the maximum measurement time is  $4.29 \times 10^9$  bits.

To keep the measurement times short for both small and large bit/block error rates, the R&S AMU provides a number of ways to end the measurement. In addition to manually interrupting the count, two termination criteria can be selected:

1. reaching a user-defined number of checked data bits/blocks;

2. a maximum number of detected errors.

The measurement stops as soon as one of the two criteria has been met. The display shows which of the two criteria caused the measurement to stop.



The BER/BLER measurement measures statistical bit/block errors, i.e. errors which do not occur at regular intervals but at random. Although a single measurement determines the exact number of errors in the measured interval, a statistically reliable BER/BLER can only be obtained when a sufficient number of errors occur in the observed interval. This is the only way to ensure that the single BER/BLER measurement result approaches the true error rate with high probability.

Bit error rates of approximately 50 % indicate a faulty measurement.

### 5.4.6 Interrupt-free measurement

In the case of continuously generated signals that contain whole-number multiples of the PRBS sequence, the measurement occurs without interruption. Only the data and clock lines of the BERT interface are used for the measurement. The length of the random sequence is 2 to the power of the degree of the polynomial minus 1. For example, PRBS9 length of 511 ( $2^9$  equals 512 minus 1).

### 5.4.7 Restart function

The "Restart" function makes it possible to perform BER measurements with short signals or with signals that are not continuously generated (and therefore do not contain any whole-number multiples of PRBS sequences). An external signal at the BERT input halts the measurement and restarts it when the data sequence begins, and the BER results of the relevant (sub)sequences are integrated.

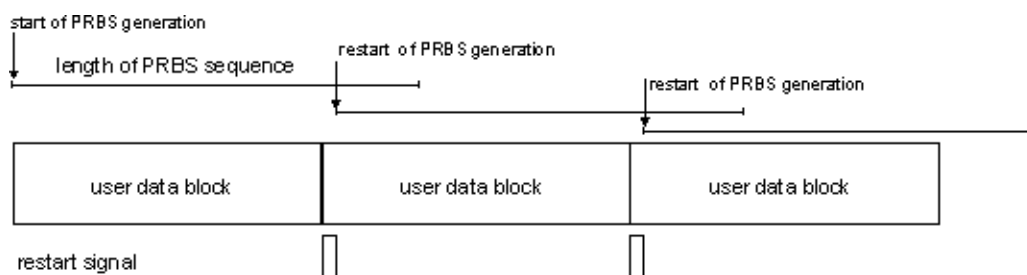

**Figure 5-5:** The length of the signal is too short for a complete PRBS sequence; PRBS generation is restarted by the Restart signal when the signal begins anew.

Frames generated by the R&S AMU or the R&S WinIQSIM2 software contain continuous PRBS data, i.e. the PRBS sequence is continuously written to the user data fields. Consequently, if the R&S AMU is used as a data source, a restart is only necessary if (e.g. when using a waveform) the total length of the signal does not equal a whole-number multiple of a PRBS sequence.



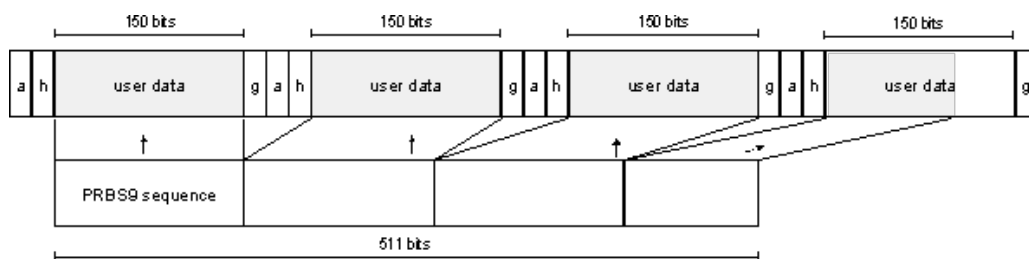

Figure 5-6: TDMA signal generated by the R&S AMU with user data that contains the PRBS data sequence. The PRBS sequence is continuously written to the user data fields.

### 5.4.8 Data Enable

In the case of the bit error rate measurement, the data signals usually contain not only PRBS data but also other data (e.g. sync and preambles, see figure) that would result in bit errors. The BER measurement for this data can then be interrupted using the "Data Enable" signal. The "Data Enable" signal is fed in at the BERT input.

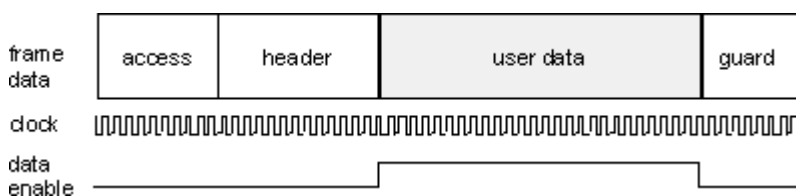

Figure 5-7: TDMA signal with user data that contains the PRBS data sequence and various check fields which should be ignored for the bit error rate measurement. Below that are the associated clock and Data Enable signals.

In the case of the block error rate measurement, the "Data Enable" signal masks the user data (see following figure).

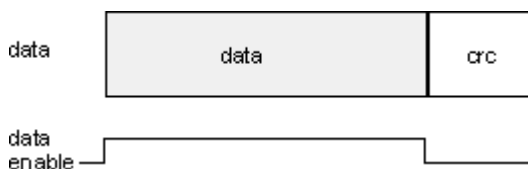

Figure 5-8: Data Enable signal with block error rate measurement.

### 5.4.9 Pattern Ignore

Bit sequences of 32 bits or more with only "1" or "0", which some mobile radio standards provide instead of frame data when faulty frames are detected, can also be excluded from the measurement using the "Pattern Ignore" function (see figure).

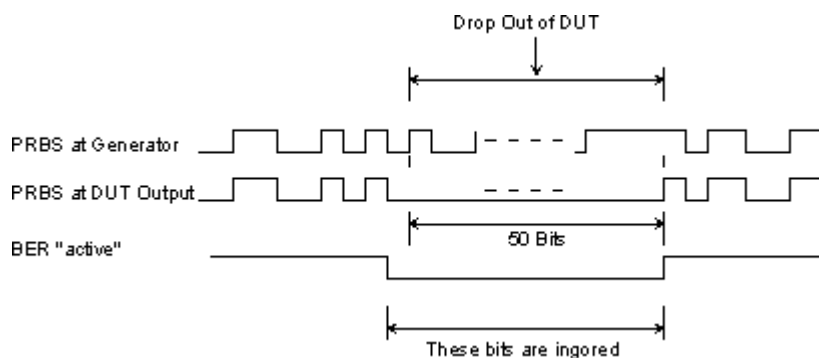
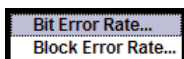

Figure 5-9: Example of functionality of Pattern Ignore: 50 bits were set to "0" by the DUT. These 50 bits plus the preceding "0" are ignored in the bit error rate measurement.

### 5.4.10 Bit Error Rate Menu



The "Bit Error Rate" menu for configuring the bit error rate measurement is called either in the "BERT" function block or via the MENU button under "BERT"

The top section of the "Bit Error Rate" menu is used to switch on the bit error rate measurement and display the results and current status of the measurement.

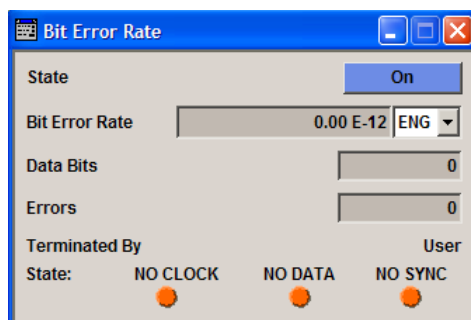

The "Configuration" section is used to select the type of measurement the data source and the termination criteria.

If the data is not cyclically continued, the measurement can be selectively interrupted and restarted. Certain data sections and frames that have been marked as faulty can be excluded from the measurement.

Configuration	
Mode	Single <input type="button" value="Execute Single"/>
Max. Data Bits	10 000 000
Max. Errors	100
PRBS	PRBS 9
Data Polarity	Norm
Clock Slope	Pos
External Restart	On
Data Enable	Not Used
Pattern Ignore	Off
Threshold (BER)	1.00 V
Impedance (BER)	1 kΩ / GND

#### 5.4.10.1 General Settings

##### State

Switches the bit error rate measurement on/off. Depending on the selection in the "Mode" box, either a continuous measurement ("Auto") or a single measurement ("Single") is carried out. A single measurement must be started by clicking the "Execute Single" button.

Remote command:

`:BERT:STATE` on page 461

##### Bit Error Rate

Displays the measured bit error rate.

The bit error rate is the ratio of occurred errors to transmitted data bits.

The display unit can be selected in the box to the right of the value.

"ENG"	The bit error rate is output in exponential notation with the exponent –3 or –6.
"SCI"	The bit error rate is output in scientific notation, i.e. standardized to one place to the left of the decimal.
"%"	The bit error rate is output in percent.
"ppm"	The bit error rate is output in parts per million.

Remote command:

`:BLER:RESult?` on page 454

`:BERT:UNIT` on page 462

##### Data Bits

Displays the current number of data bits checked.

Remote command:

`:BERT:RESult?` on page 454

**Errors**

Displays the current number of occurred errors.

Remote command:

[:BERT:RESult?](#) on page 454

**Terminated By**

Displays the termination criterion for the measurement.

These criteria can be entered to keep the duration of the measurement short for low as well as high bit error rates.

The last measurement result is displayed after the measurement has been terminated.

"User"                    The measurement was manually terminated by the user switching the state to off.

"Number of Data Bits"    The measurement was terminated because the specified number of data bits was reached

"Number of Errors"        The measurement was terminated because the specified number of errors was reached.

Remote command:

[:BERT:STATe](#) on page 461

[:BERT:STOP](#) on page 461

**State**

Displays the status of the measurement.

This enables the user to check whether the measurement functions. The status of the data and clock lines and of synchronization is checked and displayed.

If a faulty status is displayed, the signals can be checked at the BERT interface using an oscilloscope.

"Clock"                    The applied clock signal was detected.

"No Clock"                The applied clock signal was not detected. Possible causes are:

- Clock recovery is not available (e.g. with tests of RF components).

If the signal is generated using the R&S AMU, the bit clock can be extracted from the CLOCK output connector (only with "Custom Dig Mod" signals in realtime). If signals complying with other digital standards are generated or if ARB waveforms are used, a marker signal can be used as a clock. As the DUT causes a delay, the ratio of clock-to-data travel times must always be taken into account and checked with an oscilloscope if necessary.

- The wrong impedance for the applied clock rate was selected (see "Impedance" parameter).
- The wrong threshold for the applied clock signal was selected (see "Threshold").

"Data"                     The applied data signal was detected.

"No Data"	<p>The applied data signal was not detected. Only clocked-in signals are detected; if the clock signal is missing, then data changes will also not be detected.</p> <p>If the data is not detected despite the detected clock signal, this may be caused by the following:</p> <ul style="list-style-type: none"> <li>• The signal from the DUT is missing.</li> <li>• The wrong impedance for the applied clock rate was selected (see "Impedance" parameter).</li> <li>• The wrong threshold for the applied data signal was selected (see Threshold parameter).</li> </ul>
"Sync"	The measurement is synchronized.
"No Sync"	<p>The measurement is not synchronized.</p> <p>Generally, a measurement cannot be synchronized until a clock and a data signal have been detected. If synchronization still does not occur, this may be caused by the following:</p> <ul style="list-style-type: none"> <li>• The selected PRBS is not correct. For the bit error rate measurement, the PRBS sequence on which the data is based must be set on the bit error rate tester. If the PRBS is not correct, the BER measurement cannot synchronize to the data (due to the incorrect polynomial).</li> <li>• A wrong clock slope is used, which violates setup or hold times (see "Clock Slope" parameter).</li> <li>• The travel times of clock and data are unfavorable (e.g. clock slope at data change). Check the relationship of clock to data using an oscilloscope and optimize the travel times (e.g. clock slope when the data signal applied is stable).</li> <li>• Reflections on the clock line occur, clocking the data signal into the BER measurement twice, e.g. on lines without termination. The R&amp;S AMU input is not terminated.</li> <li>• Incorrect polarity of data signal (or "Data Enable" signal). In this case the PRBS cannot synchronize. Note that an inversion of the output signal specified for some cases by the PRBS standard is performed automatically upon PRBS selection. Manual inversion of the data signal is therefore not required.</li> </ul> <p>No Sync status and an error rate of approx. 50%:</p> <ul style="list-style-type: none"> <li>• A bit error occurs during synchronization (e.g. nine data bits with PRBS9). The BER measurement is set up incorrectly. This fault is internally detected and automatically corrected.</li> <li>• If data that is not cyclically continued (i.e. when a break in the sequence occurs at the memory wrap-around), the measurement will not be started at the right time. The signal on the "Restart" line enables the measurement to be started optimally at the beginning of the sequence.</li> </ul>

Remote command:

:BERT:RESult? on page 454

### 5.4.10.2 Configuration

The "Configuration" section is used to select the type of measurement, the data source and the termination criteria. If the data is not cyclically continued, the measurement can be selectively interrupted and restarted. Certain data areas and frames that have been marked as faulty can be excluded from the measurement.

#### Mode

Selects the type of measurement: single or continuous measurement.

- |          |   |
|----------|---|
| "Auto"   | <p>Continuous measurement of bit error rate.</p> <p>If either or both of the termination criteria are met, the measurement in progress is terminated and immediately a new one is started automatically. Depending on the settings made, a measurement may take considerable time. During the first measurement, intermediate results are displayed. For the measurements that follow, only the final results are shown. The parameters "Data Bits" and "Errors" are continuously updated and indicate the relative values for the measurement in progress.</p> <p>To start a continuous measurement, use the command <code>:BERT:START</code> on page 460. To stop a measurement, use the command <code>:BERT:STOP</code> on page 461.</p> |
| "Single" | <p>Single measurement of bit error rate. The measurement is started by clicking the "Execute Single" button.</p> <p>If a measurement is in progress, the current values for "Bit Error Rate", "Errors" and "Data Bits" are cyclically displayed. The measurement is terminated when either or both of the termination criteria have been reached.</p> <p>To start a new measurement, the "Execute Single" button must be clicked again.</p>   |

Remote command:

`:BERT:SEquence` on page 456

#### Max Data Bits

Enter the number of transmitted data bits to be checked before the measurement is terminated.

This criterion terminates the BER measurement after the specified number of data bits, even if very few errors or none at all have been detected. With a low number of bit errors, the measurement result may be statistically unreliable.

If the measurement is terminated because the number of data bits entered here was checked, "Number of Data Bits" appears to the right of "Terminated By".

Data excluded from the measurement by "Data Enable" or "Pattern Ignore" is not counted.

Remote command:

`:BERT:SETup:MCOUNT` on page 459

#### Max Errors

Enter the number of bit errors to occur before the measurement is terminated.

This criterion terminates the measurement relatively quickly if the error rate is high. The measurement result is statistically reliable, since many errors were already counted.

If the measurement is terminated because the number of bit errors entered here was reached, Number of Errors appears to the right of Terminated By.

Remote command:

`:BERT:SETup:MERRor` on page 459

### PRBS

Selects the PRBS sequence. The data generated by the PRBS generator is used as a reference for the measurement.

**Note:** Standard-compliant data inversion for PRBS15 and PRBS23 is performed automatically when the PRBS is selected. "Data Polarity" remains unaffected.

Remote command:

`:BERT:SETup:TYPE` on page 460

### Data Polarity

Sets the polarity of the feedback data bits.

**Note:** Standard-compliant data inversion for PRBS15 and PRBS23 is performed automatically when the PRBS is selected. "Data Polarity" remains unaffected.

"Norm"            High level stands for logic 1, low level for logic 0.

"Inv"             Low level stands for logic 1, high level for logic 0.

Remote command:

`:BERT:SETup:DATA[:POLarity]` on page 457

### Clock Slope

Sets the polarity of the active slope of the feedback clock.

"Pos"             The positive slope of the clock signal is active.

"Neg"             The negative slope of the clock signal is active.

Remote command:

`:BERT:SETup:CLOCK[:POLarity]` on page 456

### Impedance

Sets the input impedance of the BERT inputs "Clock", "Data", "Data Enable" and "Restart".

For high clock rates, 50 Ohms should be selected.

Remote command:

`[:SOURce]:INPut:BERT:IMPedance` on page 462

### Threshold

Sets high/low threshold in volts for the BERT inputs "Clock", "Data", "Data Enable" and "Restart".

The variable threshold makes it possible to align the BERT interface with the level of different input signals. In addition, reflections and other interference can be suppressed by selecting the appropriate threshold.

Remote command:

[\[:SOURce\]:INPut:BERT:THReshold](#) on page 462

### External Restart

Activates/deactivates an external restart of the BER measurement.

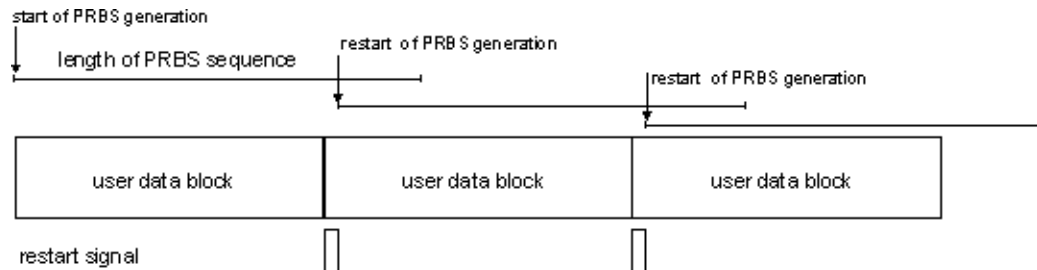

The length of the signal is too short for a complete PRBS sequence; PRBS generation is restarted by the "Restart" signal when the signal begins anew.

"Exeternal"

The reset signal for the BER measurement is fed via the "Restart" input of the BERT interface.

If the PRBS cannot be continued uninterruptedly, the BER measurement must be stopped at the end of the data sequence and subsequently restarted at the beginning of the new data sequence. The measurement is stopped and started via a 0-1-0 slope of the restart signal. A transition from logic 0 to 1 causes a partial result to be generated and the measurement to be stopped. A transition from 1 to 0 starts the measurement for the next subinterval. This measurement is synchronized anew.

If the R&S AMU is used as a data source, a signal in which a single 1 was coded at the end of the data sequence can be used as a restart signal at the R&S AMU marker output. This causes the BER measurement to stop briefly at the end of the data sequence and start again.

Partial results (number of data and error bits) are added up until the predefined total number of data or error bits is reached or exceeded. The measurement is reset by "Pattern Ignore" or "Data Enable", regardless of its status.

"Inernal"

The reset signal for the BER measurement is generated internally.

This setting is suitable for PRBS sequences that run continuously and thus ensure uninterrupted repetition.

Remote command:

[:BERT:SETup:REStart\[:STATe\]](#) on page 459

### Data Enable

Activates/deactivates the use of the "Data Enable" signal and sets the polarity of this signal if it is used.

The "Data Enable" signal marks the data that is actually to be evaluated for the BER measurement. Any data in addition to the PRBS sequence is masked and thus not evaluated (e.g. sync, preambles, other channels, etc that are present in the data bits supplied by the DUT).



The signal is fed in at the "Data Enable" input of the BERT interface. It is generated by the DUT but can also be provided by the R&S AMU in the form of a marker signal.

**Note:** If the data is not enabled, the BER measurement is stopped completely. The identification circuit for "Pattern Ignore" as well as the PRBS generator of the BER measurement wait as long as data is not enabled. If the data is enabled, the measurement is continued.

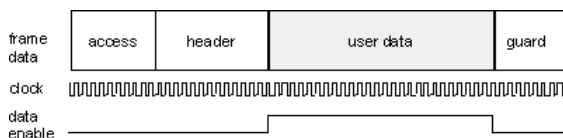

The figure shows a TDMA signal with user data that contains the PRBS data sequence and various check fields which should be ignored for the bit error rate measurement. Below that are the associated clock and "Data Enable" signals.

- "Not Used" Any signal at the "Data Enable" input is ignored; all data at the BERT data input is used for the measurement.
- "High" The "Data Enable" signal is used. The only data measured is the data at the BERT data input during a high level of the "Data Enable" signal. The measurement is interrupted during a low level of the "Data Enable" signal.
- "Low" The "Data Enable" signal is used. The only data measured is the data at the BERT data input during a low level of the "Data Enable" signal. The measurement is interrupted during a high level of the "Data Enable" signal.

Remote command:

[:BERT:SETup:DENable](#) on page 457

### Pattern Ignore

Activates/deactivates ignoring of pure "0" or "1" bit sequences at least 32 bits long. Activating "Pattern Ignore" excludes faulty frames from the measurement.

In the case of some mobile radio standards, pure "0" or "1" bit sequences are generated when errors (e.g. an incorrect checksum) are detected within a frame. These sequences, instead of the frame data, are provided for the BER measurement and signal that the frame in question should not be used for the measurement.

The R&S AMU ignores sequences of 32 bits or longer.

**Note:** While ignoring the bits, the PRBS generator for the BER measurement keeps running. Following the "0" or "1" sequence, the BER measurement is continued as if the ignored sequence had contained PRBS data.

If "Pattern Ignore" is switched on, synchronization time is 32 bits longer.

If "Pattern Ignore" and "External Restart" are active at the same time, the measurement terminates immediately when the restart signal is applied. None of the 32 bits within the "Pattern Ignore" detector is evaluated.

If "Data Enable" and "Pattern Ignore" are active at the same time, "Data Enable" is given priority, i.e. bits that are not enabled are not examined for "0" or "1" sequences.

**Example:**

50 bits were set to "0" by the DUT. These 50 bits plus the preceding "0" are ignored in the bit error rate measurement.

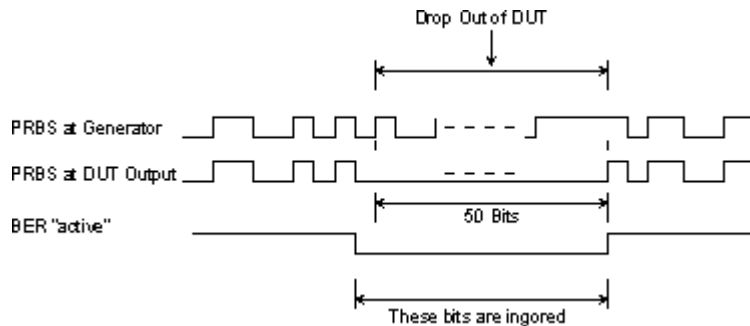

- "Off"                      Pattern Ignore is not active.
- "All 1"                    Bit sequences consisting of 32 or more consecutive "1" data are not used (i.e. ignored) for the BER measurement.
- "All 0"                    Bit sequences consisting of 32 or more consecutive "0" data are not used (i.e. ignored) for the BER measurement.

Remote command:

[:BERT:SETup:IGNore](#) on page 458 [:BERT:SETup:DENable](#) on page 457

### 5.4.11 Block Error Rate Menu

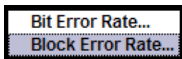

The "Block Error Rate" menu for configuring the block error rate measurement is called either in the "BERT" function block or via the MENU button under "BERT."

The top section of the "Block Error Rate" menu is used to switch on the block error rate measurement and display the results and current status of the measurement.

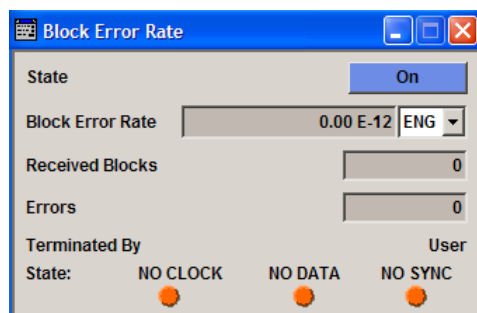

The "Configuration" section is used to select the type of measurement and the termination criteria and to set the polarity of the input signals.

Configuration	
Mode	Single <input type="button" value="Execute Single"/>
Max. Received Blocks	100 000
Max. Errors	100
BLER Type	CRC 16
CRC Order	LSB first
Data Polarity	Norm
Clock Slope	Pos
Data Enable	Low
Threshold (BER)	1.00 V
Impedance (BER)	1 kΩ / GND

### 5.4.11.1 General Settings

#### State

Switches the block error rate measurement on/off.

Depending on the setting in the "Mode" box, either a continuous measurement ("Auto") or a single measurement ("Single") is carried out. A single measurement must be started by clicking the "Execute Single" button.

Remote command:

[:BLER:STATe](#) on page 461

#### Block Error Rate

Displays the measured block error rate.

The block error rate is the ratio of faulty blocks to total blocks.

The display unit can be selected in the box to the right of the value.

"ENG"            The block error rate is output in exponential notation with the exponent  $-3$  or  $-6$ .

"SCI"            The block error rate is output in scientific notation, i.e. standardized to one place to the left of the decimal.

"%"              The block error rate is output in percent.

"ppm"           The block error rate is output in parts per million.

Remote command:

[:BLER:UNIT](#) on page 462

#### Received Blocks

Displays the current number of data blocks checked.

Remote command:

[:BLER:RESult?](#) on page 454

#### Errors

Displays the current number of occurred errors.

Remote command:

`:BLER:RESult?` on page 454

### Terminated By

Displays the termination criterion for the measurement.

These criteria can be entered to keep the duration of the measurement short for low as well as high block error rates.

The last measurement result is displayed after the measurement has been terminated.

"User"                    The measurement was manually terminated by the user switching the state to off.

Remote command:

`:BLER:STATe` on page 461

`:BLER:STOP` on page 461

"Number of Data Blocks"    The measurement was terminated because the specified number of data blocks was reached.

"Number of Errors"        The measurement was terminated because the specified number of errors was reached.

Remote command:

`:BLER:RESult?` on page 454

### State

Displays the status of the measurement.

A green LED indicates a correct status, a red LED a critical status.

This allows the user to check whether the measurement functions. The status of the data and clock lines and of synchronization is checked and displayed.

If a faulty status is displayed, the signals can be checked at the BERT interface using an oscilloscope.

"Clock"                    The applied clock signal was detected.

"No Clock"                The applied clock signal was not detected.

Possible causes are:

- Clock recovery is not available (e.g. with tests of RF components).

If the signal is generated using the instrument family, the bit clock can be extracted from the CLOCK output connector (only with "Custom Dig Mod" signals in realtime). If signals complying with other digital standards are generated or if ARB waveforms are used, a marker signal can be used as a clock. As the DUT causes a delay, the ratio of clock-to-data travel times must always be taken into account and checked with an oscilloscope if necessary.

- The wrong impedance for the applied clock rate was selected (see "Impedance" parameter).
- The wrong threshold for the applied clock signal was selected (see "Threshold" parameter).

"Data"                     The applied data signal was detected.

"No Data"	The applied data signal was not detected. Possible causes are: <ul style="list-style-type: none"> <li>• The signal from the DUT is missing.</li> <li>• The wrong impedance for the applied clock rate was selected (see "Impedance" parameter).</li> <li>• The wrong threshold for the applied data signal was selected (see "Threshold" parameter)</li> </ul>
"Sync"	The measurement is synchronized.
"No Sync"	The measurement is not synchronized. Generally, a measurement cannot be synchronized until a clock and a data signal have been detected. If synchronization still does not occur, this may be caused by the following: <ul style="list-style-type: none"> <li>• A wrong clock slope is used, which violates setup or hold times (see "Clock Slope" parameter).</li> <li>• Reflections on the clock line occur and clock the data signal into the BER measurement twice, e.g. on lines without termination. The R&amp;S AMU input is <b>not</b> terminated.</li> <li>• The travel times of clock and data are unfavorable (e.g. clock slope with data change). Check the relationship of clock to data using an oscilloscope and optimize the travel times (e.g. clock slope when the data signal applied is stable).</li> </ul>

Remote command:

[:BLER:RESult?](#) on page 454

#### 5.4.11.2 Configuration

The "Configuration" section is used to select the type of measurement and the termination criteria and to set the polarity of the input signals.

##### Mode

Selects the type of measurement: single or continuous measurement.

"Auto"	Continuous measurement of block error rate. If either or both of the termination criteria are met, the current measurement is terminated and immediately a new one is started automatically. Depending on the settings made, a measurement may take considerable time. During the first measurement, intermediate results are displayed. For the measurements that follow, only the final results are shown. The parameters "Received Blocks" and "Errors" are continuously updated and indicate the relative values for the measurement in progress. To start a continuous measurement, use the command <a href="#">:BLER:START</a> on page 460. To stop a measurement, use the command <a href="#">:BLER:STOP</a> on page 461.
--------	--

"Single" Single measurement of bit error rate. The measurement is started by clicking the "Execute Single" button.  
If a measurement is in progress, the current values for "Block Error Rate", "Errors" and "Received Blocks" are cyclically displayed. The measurement is terminated when either or both of the termination criteria have been reached. To start a new measurement, the "Execute Single" button must be clicked again.

Remote command:

:BLER:SEQuence on page 456

:TRIGger:BLER[:IMMediate] on page 463

### Max Received Blocks

Enter the number of transmitted data blocks to be checked before the measurement is terminated.

This criterion will terminate the BLER measurement after the specified number of data blocks, even if very few errors or none at all have been detected. With a low number of block errors, the measurement result may be statistically unreliable.

If the measurement is terminated because the number of data blocks entered here was checked, "Number of Data Blocks" appears to the right of "Terminated By".

Remote command:

:BLER:SETup:MCOunt on page 459

### Max Errors

Enter the number of block errors to occur before the measurement is terminated.

This criterion terminates the measurement relatively quickly if the error rate is high. The measurement result is statistically reliable, since many errors were already counted.

If the measurement is terminated because the number of block errors entered here was reached, "Number of Errors" appears to the right of "Terminated By".

Remote command:

:BLER:SETup:MERRor on page 459

### CRC Order

Selects the byte order of the checksum (CRC).

"LSB" The checksum starts with the least significant byte.

"MSB" The checksum starts with the most significant byte.

Remote command:

:BLER:SETup:CORDer on page 457

### BLER Type

Displays the CRC polynomial used. CCITT CRC 16 :  $G(x) = x^{16} + x^{12} + x^5 + x^1$  is the CRC polynomial supported.

Remote command:

:BLER:SETup:TYPE on page 460

**Data Polarity**

Sets the polarity of the feedback data blocks.

Remote command:

`:BLER:SETup:DATA[:POLarity]` on page 457

**Clock Slope**

Sets the polarity of the active slope of the feedback clock.

Remote command:

`:BLER:SETup:CLOCK[:POLarity]` on page 456

**Impedance**

Sets the input impedance of the BERT inputs "Clock", "Data", "Data Enable" and "Restart".

For high clock rates, 50 Ohms should be selected.

Remote command:

`[:SOURce]:INPut:BERT:IMPedance` on page 462

**Threshold**

Sets high/low threshold in volts for the BERT inputs "Clock", "Data", "Data Enable" and "Restart".

The variable threshold makes it possible to align the BERT interface with the level of different signals. In addition, reflections and other interference can be suppressed by selecting the appropriate threshold.

Remote command:

`[:SOURce]:INPut:BERT:THReshold` on page 462

**Data Enable**

Sets the polarity of the "Data Enable" signal.

The "Data Enable" signal marks the user data of the signal.

The signal is generated by the DUT and fed in at the "Data Enable" input of the BERT interface.

"High"                    If the "Data Enable" signal is at a high level, the data bits at the BERT data input are interpreted as user data. During a low level of the "Data Enable" signal, they are interpreted as checksum bits.

"Low"                     If the "Data Enable" signal is at a low level, the data bits at the BERT data input are interpreted as user data. During a high level of the "Data Enable" signal, they are interpreted as checksum bits.

Remote command:

`:BLER:SETup:DENable` on page 457

## 5.5 Output of Digital and Analog Baseband Signal - I/Q Out

The R&S AMU provides various outputs of the baseband signals. The digitally modulated signals can either be output directly or converted to analog I/Q baseband output signals. The analog signal can be output single-ended or differential (non-inverted).

An external digital signal interface module, the R&S EX-IQ-BOX, can be connected, providing parallel or serial signal transmission to external devices.

The settings for the analog and digital output are available in the block diagram in the "I/Q Out" function block of each path as well as in the "I/Q Out" menus which are opened using the MENU key.

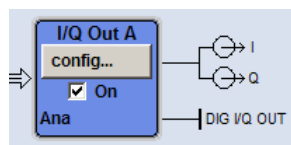

The **analog** baseband signal is output at the I/Q output connectors I OUT A/B and Q OUT A/B on the front panel of the instrument.

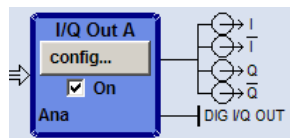

The differential output of the **analog** baseband signal requires the option R&S AMU-B16, Differential I/Q Out. The signal is output at the connectors I OUT /I OUT BAR and Q OUT /Q OUT BAR on the front panel of the instrument.

The output of the analog baseband signal at the rear panel of the instrument requires an option for rear panel connectors (option R&S AMU-B81, I/Q Rear Connectors). This option is recommended for use of the instrument in a 19" rack. Installing the instrument in a 19" rack requires a rack adapter or an adapter for telescopic sliders.

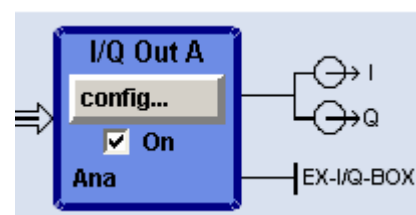
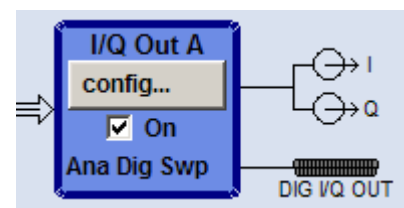

The output of the **digital** baseband signal requires the option R&S AMU-B18, Digital I/Q Out. The signal is output at the digital interface on the rear panel. If an R&S EX-IQ-BOX is connected, the R&S Instrument recognizes this module automatically and indicates a labeled symbol of the R&S EX-IQ-BOX at the corresponding function block.

The differential output of the baseband signal in two-path instruments requires a second option R&S AMU-B16, Differential I/Q Out and, for digital output a second option R&S AMU-B18, Digital I/Q Out respectively.





To avoid electromagnetic interference (EMI), we recommend that you exclusively use the cable R&S SMU-Z6 for connection to the digital interface BBOUT.

Depending on the settings in the "I/Q Out" dialogs the activated outputs of the currently selected path are switched on in the "I/Q Out Settings" dialog of the corresponding path as well as by ticking the checkbox On of the "I/Q Out" function block.

### I/Q Out Settings

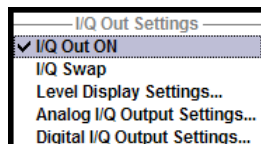

In the "I/Q Out Settings" menu the currently activated outputs can be switched on ("I/Q Out ON"), the "I/Q Swap" can be activated and the settings dialogs can be opened for:

- [Chapter 5.5.2, "Level Display Settings"](#), on page 210
- [Chapter 5.5.3, "Analog I/Q Output Settings"](#), on page 212
- [Chapter 5.5.4, "Digital I/Q Output Settings"](#), on page 217

## 5.5.1 Switching I/Q Out On/Off

### BASEBD ON/OFF

**Note:** With the aid of the "BASEBD ON/OFF" key the active baseband output signals of both paths can be switched on and off. The BASEBD ON/OFF key is located on the front panel of the instrument.

For manual remote control the BASEBD ON/OFF key can be substituted by a key emulation (see [Chapter 5.2.3.8, "Check Front Panel"](#), on page 147).

Switches Off all active I/Q outputs of **both** paths. A second stroke restores the status that was active before the last switch-off. "I/Q OUT Off" is displayed in the status bar.

The outputs can be activated in the dialogs "Analog and Digital I/Q Out Settings" of the "I/Q Out" block.

"On"

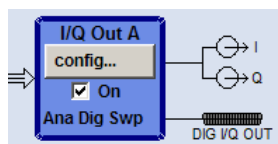

Switches on the active I/Q outputs of the corresponding "I/Q Out" block. The status line in the block displays the currently active output types, e.g. "Ana Dig" denotes that the I/Q baseband signal is provided at the analog and at the digital I/Q output. The output symbols display the active state (I OUT/Q OUT in single ended mode, I OUT BAR/Q OUT BAR in differential mode, respectively).

"Off"

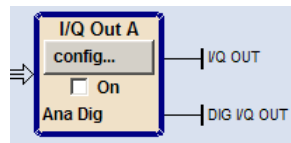

Switches off the I/Q output signal of the corresponding "I/Q Out" block. Vertical lines replace the output symbols to denote that the outputs are inactive.

Remote command:

`:OUTPut:IQ:ALL[:STATe]` on page 639

### I/Q Out ON

Switches On/Off the active I/Q outputs of the corresponding I/Q Out block.

The outputs are activated in the submenus of the I/Q Out block.

Remote command:

`[:SOURce<hw>]:IQ:OUTPut:STATe` on page 641

### I/Q-Swap

Activates swapping of the I and Q signal components, which mirrors the spectrum at the  $f=0$  line and inverts the sign of the frequency.

The I/Q swap may be needed for compliance with CDMA2000 standards (see description "Digital Standard CDMA2000").

Remote command:

`[:SOURce<hw>]:IQ:OUTPut:SWAP[:STATe]` on page 641

## 5.5.2 Level Display Settings

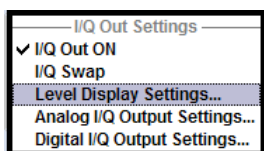

The Level Display Settings dialog is opened either in the "I/Q Out" function block or in "I/Q Out Settings" menu or by using the "MENU" key under "IQ Out A/B".

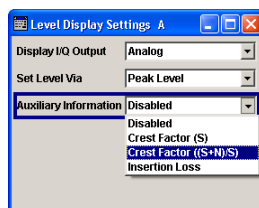

### Display I/Q-Output

Selects the output type for which the signal level of the corresponding path is set in the status bar. After selecting the I/Q output types the status line of the corresponding path displays "Analog I/Q Out" or "Digital I/Q Out", according to this setting.

"Analog" The signal level is set for the **analog** signal output. Depending on the selected analog output type, i.e. "Single Ended" or "Differential", the corresponding level entry fields are displayed in the status bar.

"Digital" The signal level is set for the **digital** signal output. The level entry fields are displayed in the status bar.

Remote command:

[ :SOURce<hw> ] :IQ:OUTPut:DISPlay on page 639

### Set Level Via

Selects the level type (peak level/level) that is used to set the signal level. The entry field is activated in the status bar and the value can be edited directly. Either the "Peak Level" or the "Level" entry field can be edited in a path.

The level entry fields and the corresponding units are displayed in the status bar.

For **analog** signal output the signal level (Peak Level/Level) can be set in volts (V) or millivolts (mV), or in decibel referenced to milliwatt (dBm). dBm can only be selected if the load type of the analog output is set to 50 Ohm (single ended) or to 100 Ohm (differential).

For **digital** signal output the signal level (Peak Level/Level) can be set in full scale ratio (FS) or in decibel referenced to full scale (dBFS).

**Note:** The signal level of the active signal is set via this selected level type. That affects both the digital and the analog signal output (see [Analog I/Q Output Settings > Set Level Via, page 214](#) and [Digital I/Q Output Settings > Set Level Via, page 211](#)).

"Peak Level" The signal level is expressed in terms of a peak envelope power value (PEP).

PEP -0.95 dBFS

If noise is added to the baseband signal, the peak level value is referred to the sum, signal and noise, also shown in the status bar by the symbol "PEP S+N".

PEP  
S+N

"Level" The signal level is expressed in terms of a rms value.

Level -5.59 dBFS

**Note:** The Level display does not consider the power difference between both paths based on unequal steering matrix, i.e. the displayed power level has to be reduced by a special MIMO Fading Power Correction value (see ["MIMO Fading Power Correction - Digital Impairments - Measurement"](#) on page 235)

The level always refers to the RMS value of the output signal without noise, even if the AWGN generator is activated.

Remote command:

[ :SOURce<hw> ] :IQ:OUTPut:POWer:VIA on page 640

### Auxiliary Information

Selects auxiliary information to be displayed in the status bar for the corresponding path. The parameters insertion loss or crest factor can be indicated to help the user setting up a fading scenario.

After selecting the parameters the status line of the I/Q Out block displays the appropriate information for the selected signal path.

"Disabled"	Indicates no auxiliary parameters in the status bar.
"Crest Factor (S)"	Indicates the crest factor of the output signal without noise. CrestFactor(S) = Peak Level(S) / Level(S)
"Crest Factor ((S+N)/S)"	Indicates the ratio of the peak value of the signal plus noise, to the RMS level of the signal without noise. CrestFactor((S+N)/S) = Peak Level(S+N) / Level(S)
"Insertion Loss"	Indicates the decrease in signal power of the baseband input signal resulting from the insertion loss of the instrument. Insertion loss is defined as the ratio of the input signal level to the output signal level and is expressed in dB.

**Note:** To enable the display settings both, baseband input and I/Q output display must be operated in the same mode, either in digital mode or analog mode.

Remote command:

[\[:SOURce<hw>\]:IQ:OUTPut:DISPlay:AINformation](#) on page 640

### 5.5.3 Analog I/Q Output Settings

The analog baseband signal is output at the I/Q output connectors I OUT A/B and Q OUT A/B of the corresponding path (path A and path B). The settings for the analog output are available in the block diagram in the "I/Q Out" function block of each path as well as in the "I/Q Out" menu which is opened using the MENU key.

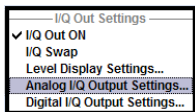

"Analog I/Q Output Settings" opens the dialog to set the output type and voltages. This dialog is only available with the option R&S AMU-B16, Differential I/Q Out.

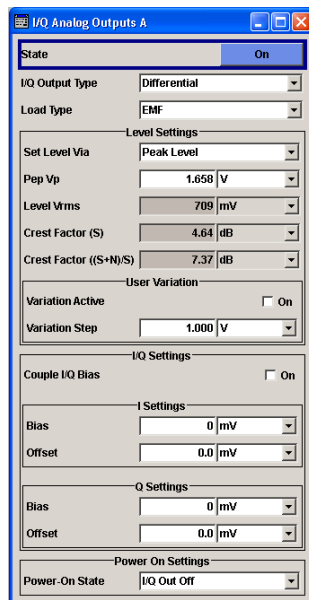

#### State

Switches On / Off the analog I/Q output signal of the currently selected path.

Remote command:

`[ :SOURce<hw> ] :IQ:OUTPut:ANALog:STATe` on page 648

### I/Q Output Type

Selects the type of output. The analog outputs can be operated in "Single Ended" mode or "Differential" (non-inverted) mode. The menu changes depending on the selected output mode

"Differential" Differential output at I OUT and I OUT BAR or Q OUT and Q OUT BAR.  
The analog I/Q signal components are output at I/Q OUT and I/Q OUT BAR. A bias to set the operating point of DUT can be defined. In addition an offset between inverting and non-inverting output can be set to balance a difference of the best operating points.

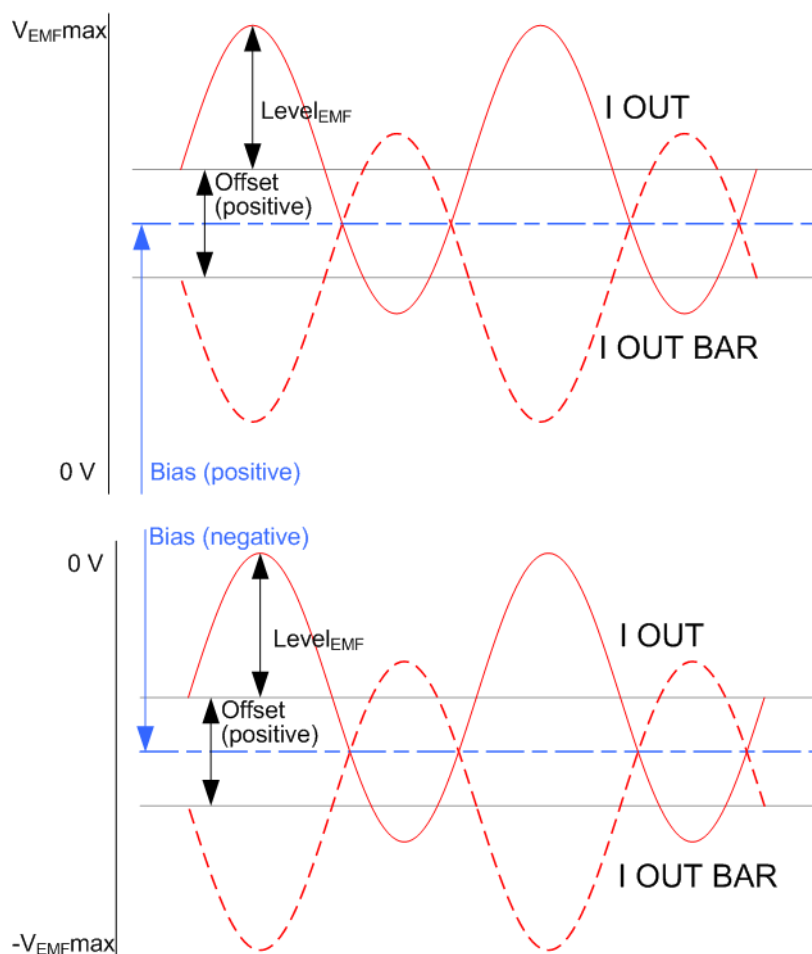

"Single Ended" Single-ended output at I OUT and Q OUT.  
A bias between I/Q OUT and ground can be defined (requires the option R&S AMU-B16, Differential I/Q Output).

Remote command:

`[ :SOURce<hw> ] :IQ:OUTPut [ :ANALog ] :TYPE` on page 648

**Load Type**

Selects the load type of the analog output signal.

The analog outputs can be operated in single ended mode or differential (non-inverted) mode. Depending on the output mode the load type varies:

- Single ended output  
The load type can be EMF (high-Z load) or 50 Ohm.
- Differential output  
The load type can be EMF (high-Z load) or 100 Ohm.

The selected load type is displayed in the status bar of the corresponding path.

Remote command:

`[ :SOURce<hw> ] :IQ:OUTPut [ :ANALog ] :LOAD` on page 644

**Set Level Via**

Selects the level type (Peak Level/Level) that is used to set the signal level. Depending on the selected level type either the Pep Vp or the Level Vrms entry field can be edited.

**Note:** The signal level of the active signal is set via this selected level type. That affects both the digital and the analog signal outputs (see [Digital I/Q Output Settings > Set Level Via, page 211](#)).

Remote command:

`[ :SOURce<hw> ] :IQ:OUTPut :POWer :VIA` on page 640

**Pep Vp**

Sets the output peak envelope voltage for both signal components (I and Q).

PEP Vp refers to the load resistance. Setting EMF the entire value range is available. Using 50 Ohm or 100 Ohm, the value range decreases and the PEP setting must be adjusted to the load type.

The range of values changes proportional to the load type:

- Single ended output  
Value range: 20 mV ... 2 V EMF  
The maximum overall output voltage (" $PEP_{EMF}$ " + " $|Bias_{EMF}|$ ") is 3.7 V.  
For the load type 50 Ohm the limit is 1.85 V.
- Differential output  
Value range: 40 mV ... 4 V EMF  
The maximum overall output voltage (" $0.5 * PEP_{EMF}$ " + " $|Bias_{EMF}|$ " +  $0.5 * Off-set_{EMF}$ ") is 3.7 V.  
For the load type 100 Ohm the limit is 1.85 V.

Remote command:

`[ :SOURce<hw> ] :IQ:OUTPut [ :ANALog ] :POWer :PEP` on page 646

**Level Vrms**

Sets the output rms voltage for both signal components (I and Q).

Level Vrms refers to the load resistance. When changing the load type, the level setting must be adjusted.

- Single ended output  
Value range: 20 mV ... 2 V EMF

The maximum overall output voltage ("Level" + "|Bias|") is 3.7 V.

For the load type 50 Ohm the limit is 1.85 V.

- Differential output

Value range: 40 mV ... 4 V EMF

The maximum overall output voltage ( $0.5 * \text{Level}_{\text{EMF}} + |\text{Bias}_{\text{EMF}}| + 0.5 * \text{Offset}_{\text{EMF}}$ ) is 3.7 V.

For the load type 100 Ohm the limit is 1.85 V.

Remote command:

`[ :SOURce<hw> ] :IQ:OUTPut [ :ANALog ] :POWer:LEVel` on page 645

### Variation Active

Activates the user-defined step width used when varying the level value with the rotary knob.

"On"                    The level value set with the rotary knob is varied using the user-defined step width which is entered under "Variation Step".

"Off"                    The level value set with the rotary knob is varied in steps of one unit at the cursor position (standard operating mode).

Remote command:

`[ :SOURce<hw> ] :IQ:OUTPut [ :ANALog ] :POWer:STEP:MODE` on page 647

### Variation Step

Sets the user defined step width for entering the level value using the rotary knob.

Level variation with this step width must be activated with "Variation Active ON".

Variation steps refers to the load resistance. When changing the load type, the level setting must be adjusted.

Remote command:

`[ :SOURce<hw> ] :IQ:OUTPut [ :ANALog ] :POWer:STEP [ :INCRement ]`  
on page 647

### Couple IQ Bias

(Variable output mode only)

Activates/deactivates coupling of bias setting of the I-signal and Q-signal component.

For activated coupling, the setting can be made for the I-signal component, it automatically applies to the Q-signal component as well. The fields for setting the Q-signal component are shaded.

Remote command:

`[ :SOURce<hw> ] :IQ:OUTPut [ :ANALog ] :BIAS:COUPling [ :STATe ]` on page 642

### Bias (EMF)

Sets the bias. A DC voltage is superimposed upon the I or Q signal. The maximum overall voltage ( $\text{Level}_{\text{EMF}} + \text{Bias}_{\text{EMF}} + \text{Offset}_{\text{EMF}}$ ) is 3.7 volts.

The bias refers to the load resistance. When changing the "Load Type", the bias setting must be adjusted.

This way, the operating point of a DUT can be set.

Remote command:

[ :SOURce<hw> ] :IQ:OUTPut [ :ANALog ] :BIAS:I on page 642

[ :SOURce<hw> ] :IQ:OUTPut [ :ANALog ] :BIAS:Q on page 642

### Offset (EMF)

(available only for output type "Differential" only)

Sets an offset between the inverting and the non-inverting output.

The offset refers to the load resistance. Changing the "Load Type", the offset setting must be adjusted.

The value range is dynamically adjusted in order to respect the following constrains:

The maximum overall voltage (" $0.5 * \text{Level}_{EMF} + |\text{Bias}_{EMF}| + 0.5 * \text{Offset}_{EMF}$ ") is 3.7 V.

The set value is set half in the positive and half in the negative direction:

- A **positive offset** is set with half of the value in positive direction at the non-inverting outputs, in negative direction at the inverting outputs, respectively. For example, if a 100.0 mV offset value is set for the I signal component, the output signal at "I OUT" will have a 50.0 mV offset and the output signal at "I OUT Bar" will have a -50.0mV offset.

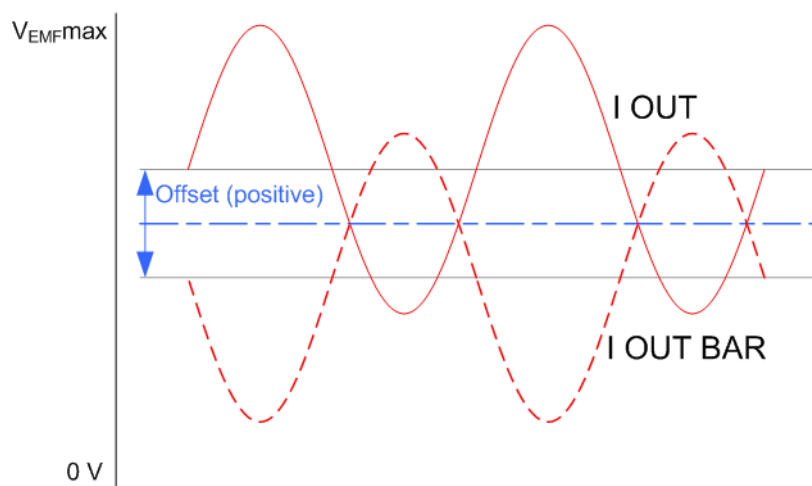

- A **negative offset** is set with half of the value in negative direction at the non-inverting outputs, in positive direction at the inverting outputs, respectively.



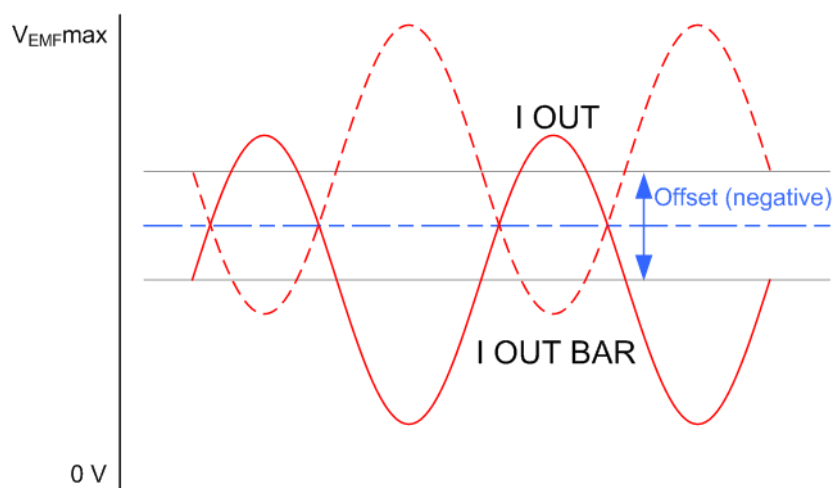

Remote command:

`[ :SOURce<hw> ] :IQ:OUTPut [ :ANALog ] :OFFSet:I` on page 643

`[ :SOURce<hw> ] :IQ:OUTPut [ :ANALog ] :OFFSet:Q` on page 643

#### Power-On State

Selects the state which the analog I/Q Output is to resume after the instrument is switched on.

"I/Q Out Off" The output is deactivated when the instrument is switched on.

"Previous Setting" When the instrument is switched on the analog I/Q output resumes to the status that was active before the last switch off.

Remote command:

`[ :SOURce<hw> ] :IQ:OUTPut [ :ANALog ] :PON` on page 645

### 5.5.4 Digital I/Q Output Settings

The digital baseband signal is output at a standardized (LVDS) digital I/Q interface.

To access the settings for the digital I/Q output:

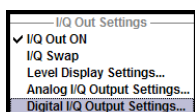

1. select "Block Diagram > I/Q Out A/B > Config... > Digital I/Q Output Settings" or
2. press the MENU key and select "I/Q Out > Digital I/Q Output Settings".

The output of the digital baseband signal is available with the option R&S AMU-B18, Digital I/Q Out. Two-path instruments require a second option R&S AMU-B18, Digital I/Q Out for digital output.

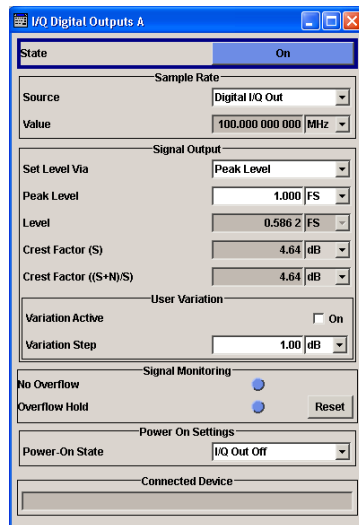

If an "R&S EX-IQ-BOX" is connected the R&S AMU recognizes this module automatically. Then, the button "EX-I/Q-Box Settings..." is displayed in the "Digital I/Q Output Settings" dialog for configuring the parameters of the R&S EX-IQ-BOX (see "R&S EX-IQ-BOX" Manual). Additionally the components of the recognized R&S EX-IQ-BOX are listed in the Hardware Config, section Baseband Assembly.

#### 5.5.4.1 Digital I/Q Output General Settings

##### State - Digital I/Q Output

Switches On/Off the digital I/Q output signal.

"On" Switches on the digital I/Q output signal of the currently selected path.

"Off" Switches off the I/Q output signal of the currently selected path.

Remote command:

`[ :SOURce<hw> ] :IQ:OUTPut:DIGital:STATe` on page 654

##### EX-I/Q-Box Settings... - Digital I/Q Output

(With a connected R&S EX-IQ-BOX only)

Opens the main settings dialog of the R&S EX-IQ-BOX.

Remote command:

n.a.

#### 5.5.4.2 Sample Rate

In the "Sample Rate" section the sample rate for the digital I/Q output signal can be set and the state of signal transmission is indicated by the FIFO Status.

##### Sample Rate Source - Digital I/Q Output

Selects the source for the sample rate of the digital I/Q output signal.

**Note:** With a connected **R&S EX-IQ-BOX** either the internal clock source (User defined) or an external clock (Digital I/Q In) can be selected in the settings dialog of the R&S EX-IQ-BOX. Therefore, the sample rate source is only indicated in this field.

"User Defined"	The internally generated clock reference signal is used. The sample rate is calculated and displayed in the field "Value".
"Digital I/Q In"	An external clock reference signal is used. The clock signal is fed in via a "Baseband Input Module" (option R&S AMU-B17). The sample rate is estimated and displayed in the field "Value".
"Digital I/Q Out"	An external clock reference signal is used. The clock signal is directly fed in via pin CLK2 of the digital output interface (option R&S AMU-B18, Digital I/Q Out). The sample rate is estimated and displayed in the field "Value".

Remote command:

`[ :SOURce<hw> ] :IQ:OUTPut:DIGital:SRATe:SOURce` on page 653

#### Sample Rate Value - Digital I/Q Output

Sets or displays the sample rate of the digital I/Q output signal, depending on the selected sample rate "Source".

Remote command:

`[ :SOURce<hw> ] :IQ:OUTPut:DIGital:SRATe` on page 653

#### FIFO Status - Digital I/Q Output

Indicates the state of the signal transmission.

"OK"	Resampling is working properly.
"OFL = Overflow"	The external sample rate frequency is too high which causes an overflow in signal transmission.
"URUN = Underrun"	The external sample rate is too low which causes an underrun in signal transmission.

Remote command:

`[ :SOURce<hw> ] :IQ:OUTPut:DIGital:SRATe:FIFO[:STATus]?` on page 653

### 5.5.4.3 Signal Output

The level of the output signal is set in the "Signal Output" section. For entering the value, level type "Peak Level" or "Level" can be selected.

#### Set Level Via

Selects the level type (peak level/level) that is used to set the signal level. The entry field is activated in the status bar and the value can be edited directly. Either the "Peak Level" or the "Level" entry field can be edited in a path.

The level entry fields and the corresponding units are displayed in the status bar.

For **analog** signal output the signal level (Peak Level/Level) can be set in volts (V) or millivolts (mV), or in decibel referenced to milliwatt (dBm). dBm can only be selected if the load type of the analog output is set to 50 Ohm (single ended) or to 100 Ohm (differential).

For **digital** signal output the signal level (Peak Level/Level) can be set in full scale ratio (FS) or in decibel referenced to full scale (dBFS).

**Note:** The signal level of the active signal is set via this selected level type. That affects both the digital and the analog signal output (see [Analog I/Q Output Settings > Set Level Via](#), page 214 and [Digital I/Q Output Settings > Set Level Via](#), page 211).

"Peak Level" The signal level is expressed in terms of a peak envelope power value (PEP).

PEP -0.95 dBFS

If noise is added to the baseband signal, the peak level value is referred to the sum, signal and noise, also shown in the status bar by the symbol "PEP S+N".

PEP S+N

"Level" The signal level is expressed in terms of a rms value.

Level -5.59 dBFS

**Note:** The Level display does not consider the power difference between both paths based on unequal steering matrix, i.e. the displayed power level has to be reduced by a special MIMO Fading Power Correction value (see ["MIMO Fading Power Correction - Digital Impairments - Measurement"](#) on page 235)

The level always refers to the RMS value of the output signal without noise, even if the AWGN generator is activated.

Remote command:

[\[:SOURce<hw>\]:IQ:OUTPut:POWer:VIA](#) on page 640

#### Peak Level - Digital I/Q Out

The signal level is expressed in terms of a peak envelope power value (peak level).

The level entry fields and the corresponding units are displayed in the status bar. The level display always refers to both signal components ( $\text{SQR}(I^2+Q^2)$ ).

Remote command:

[\[:SOURce<hw>\]:IQ:OUTPut:DiGital:POWer:PEP](#) on page 651

#### Level - Digital I/Q Out

The signal level is expressed in terms of an rms level value.

The level entry fields and the corresponding unit are displayed in the status bar. The level display always refers to both signal components ( $\text{SQR}(I^2+Q^2)$ ).

Remote command:

[\[:SOURce<hw>\]:IQ:OUTPut:DiGital:POWer:LEVel](#) on page 651

#### 5.5.4.4 User Variation

If the level is set using the rotary knob, the step width is defined in the User Variation section.

**Variation Active - Digital I/Q Out**

Activates the user-defined step width that is used by varying the level value with the rotary knob.

- "On"                    The level value set with the rotary knob is varied using the user-defined step width which is entered under "Variation Step".
- "Off"                    The level value set with the rotary knob is varied in steps of one unit at the cursor position (standard operating mode).

Remote command:

`[ :SOURce<hw> ] :IQ:OUTPut:DIGital:POWer:STEP:MODE` on page 652

**Variation Step - Digital I/Q Out**

Sets the user defined step width for entering the level value using the rotary knob. Level variation with this step width must be activated with "Variation Active ON".

Remote command:

`[ :SOURce<hw> ] :IQ:OUTPut:DIGital:POWer:STEP[:INCRement]` on page 652

**5.5.4.5 Signal Monitoring**

The section "Signal Monitoring" indicates digital signal clipping.

**Overflow - Digital I/Q Out**

Indicates that the I/Q output signal is currently clipped. This indication also appears in the block diagram close to the digital I/Q Out connector.

Overload may occur, e.g. if the level of the output signal, or the noise level (AWGN) are too high.

Remote command:

`[ :SOURce ] :IQ:OUTPut:DIGital:OFLow:STATe?` on page 651

**Overflow Hold - Digital I/Q Out**

Indicates an overflow since last reset.

The overflow hold state can be reset via the "Reset" button next to the LED, or is reset automatically by starting a new signal generation or by setting new values to the output level.

Remote command:

`[ :SOURce ] :IQ:OUTPut:DIGital:OFLow:HOLD:STATe?` on page 650

**Reset - Digital I/Q Out**

Executes a reset of the overflow hold state and LED.

Remote command:

`[ :SOURce ] :IQ:OUTPut:DIGital:OFLow:HOLD:RESet` on page 650

**5.5.4.6 Power On Settings**

The power on behaviour of the R&S AMU is set in the "Power On Settings" section.

**Power-On State - Digital I/Q Out**

Selects the state which the digital I/Q Output is to resume after the instrument is switched on.

"I/Q Out Off" The output is deactivated when the instrument is switched on.

"Previous Setting" When the instrument is switched on the digital I/Q output resumes to the status that was active before the last switch off.

Remote command:

`[ :SOURce<hw> ] :IQ:OUTPut:DIGital:PON` on page 651

**Connected Device - Digital I/Q Out**

if the connection is properly established and signal transmission is active, this parameter indicates the ID of an externally connected Rohde&Schwarz instrument.

Remote command:

`[ :SOURce<hw> ] :IQ:OUTPut:DIGital:CDEvice?` on page 649

## 5.6 Impairment of Digital I/Q Signal and Noise Generator - AWGN/IMP Block

The R&S AMU allows the digital I/Q signal to be impaired before it is passed to the I/Q output, and also noise to be added to the signal. The noise generator can also be used to generate a pure noise signal.

These settings are available in the block diagram in the "AWGN/IMP" function block as well as in the menu with the same name which is opened using the MENU key.

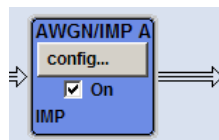

The equipment options for the basic unit (R&S AMU with frequency option R&S AMU-B9/B10/B11) include the option R&S AMU-B13 (Baseband Main Module) for Impairments and the option R&S AMU-K62 (Noise Generator) for "AWGN".

Two-path instruments require a second option R&S AMU-B9/B10/B11 (Baseband Generator) and a second option R&S AMU-B13 option (Baseband Main Module) for impairment of a signal on path B. Noise can be generated alternately for both paths using the option R&S AMU-K62 (Noise Generator). Simultaneous noise generation on both paths requires a second option.

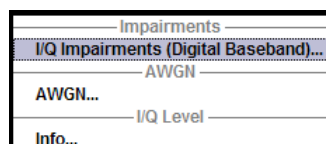

Selecting the menu item "I/Q Impairments (Digital Baseband)..." opens the I/Q impairment settings dialog. This dialog covers the settings for I/Q impairment, like carrier leakage, imbalance and quadrature offset.

To access the AWGN settings, select "AWGN...". This dialog contains the settings of the AWGN generator, noise level configuration and CW interfering parameters.

In case of two-path instruments, the analog I/Q output signal can be assigned either to path A or path B.

"Info..." opens a dialog, displaying information on the baseband power.

### 5.6.1 Impairments

Signal impairments (**I/Q Impairments**) are well-defined arithmetic modifications of the data. Every data sample is modified in the same way.

Impairment of the digital I/Q signal can be used to:

- compensate the distortion of a test object
- check the effect of a disturbed signal on a test object
- if the internal compensation of signal distortion is deactivated by the I/Q modulator, also to test its own baseband components.

#### 5.6.1.1 Gain and Gain Imbalance

An I/Q gain is a multiplication of all I/Q amplitudes by a common factor. The effect is equivalent to two identical I and Q gain factors. The effect of an increased gain factor in the I/Q constellation diagram is shown on [Figure 5-10](#).

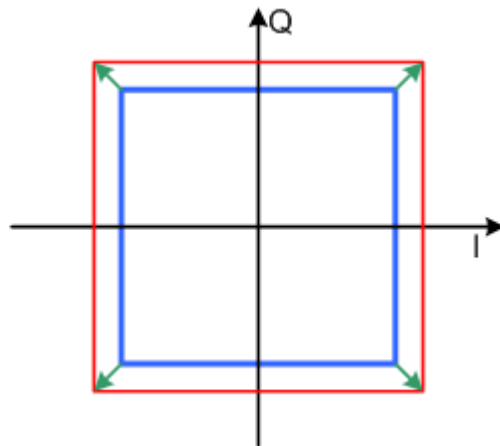

*Figure 5-10: Effect of an increased amplitude in the I/Q constellation diagram*

An I gain multiplies the I amplitudes by a factor, leaving the Q amplitudes unchanged. A Q gain has the opposite effect. Different I and Q gain factors result in an I/Q imbalance, which is due to different gains of the amplifiers in the I and Q channels of the I/Q modulator. The effect of a positive and negative gain imbalance is shown on [Figure 5-11](#).

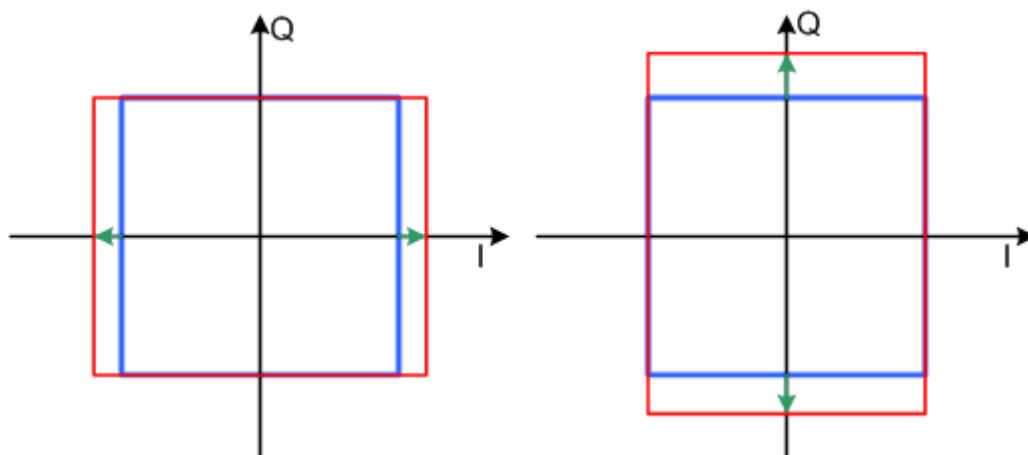

Figure 5-11: Negative gain imbalance (left) and positive gain imbalance (right) in the I/Q constellation diagram

### 5.6.1.2 I and Q Offset

An I offset adds a constant value to all I amplitudes, leaving the Q amplitudes unchanged. A Q offset has the opposite effect. A combination of I and Q values results in an I/Q offset, which is due to carrier feedthrough in the I/Q modulator. Possible reasons are interfering signals at the RF carrier frequency, e.g. an unsuppressed RF carrier subchannel. The effect of a positive I and Q offset in the I/Q constellation diagram is shown on [Figure 5-12](#).

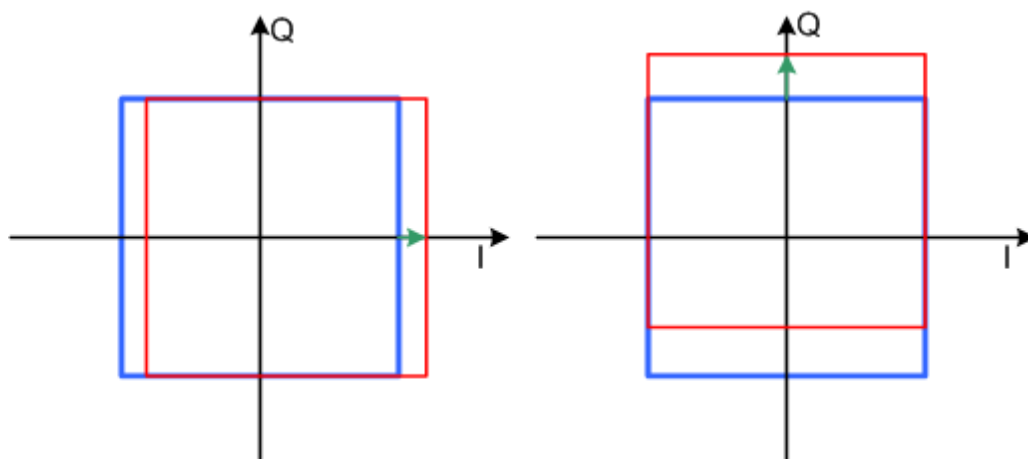

Figure 5-12: I offset (left) and Q offset (right) in the I/Q constellation diagram

### 5.6.1.3 Quadrature Offset

Changes the phase angle between the I and the Q vectors from the ideal 90 degrees, while the amplitudes are maintained. A positive quadrature offset results in a phase angle greater than 90 degrees. The effect of a positive quadrature offset in the I/Q constellation diagram is shown on [Figure 5-13](#).



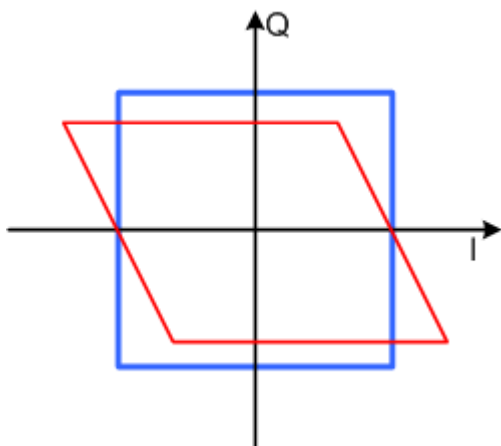
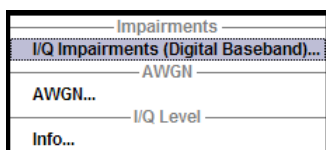

Figure 5-13: Positive quadrature offset in the I/Q constellation diagram

### 5.6.1.4 Impairment Settings Menu

To access the "Impairment Settings" menu for setting the digital I/Q impairments, select "AWGN/IMP > Configure > I/Q Impairments" or use the MENU key under "AWGN/IMP".



I/Q impairment is activated and set in the "I/Q Impairments" section.

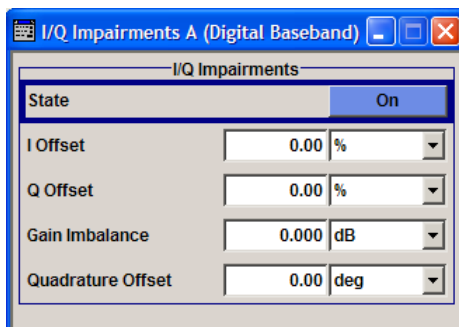

#### I/Q Impairments

In the "I/Q Impairments" section the parameters for carrier leakage, imbalance and quadrature offset can be set and I/Q impairment is activated.

#### State - Digital Impairments

Activates/deactivates digital I/Q impairment.

When activated, the settings for carrier leakage, I/Q imbalance and quadrature offset become effective.

Internal predistortion for compensating the I/Q modulator is not influenced by this setting.

Remote command:

`[ :SOURce<hw> ] :BB:IMPairment:STATe` on page 600

#### I/Q Offset - Digital Impairments

Sets the carrier leakage (in percent) of the amplitudes (scaled to the peak envelope power (PEP)) for the I and/or Q signal component. An ideal I/Q modulator suppresses the carrier leakage completely (offset = 0 percent).

For more information, see [Chapter 5.6.1.2, "I and Q Offset"](#), on page 224.

Remote command:

`[ :SOURce<hw> ] :BB:IMPairment:LEAKage:I` on page 599

`[ :SOURce<hw> ] :BB:IMPairment:LEAKage:Q` on page 599

#### Gain Imbalance - Digital Impairments

Sets the imbalance of the I and Q vector (see [Chapter 5.6.1.1, "Gain and Gain Imbalance"](#), on page 223).

The entry is made in dB (default) or %, where 1 dB offset is roughly 12 % according to the following:

$$\text{Imbalance [dB]} = 20 \log ( | \text{GainQ} | / | \text{GainI} | )$$

Positive values mean that the Q vector is amplified more than the I vector by the corresponding percentage. Negative values have the opposite effect.

Remote command:

`[ :SOURce<hw> ] :BB:IMPairment:IQRatio[:MAGNitude]` on page 598

#### Quadrature Offset - Digital Impairments

Sets the quadrature offset (see [Chapter 5.6.1.3, "Quadrature Offset"](#), on page 224).

Remote command:

`[ :SOURce<hw> ] :BB:IMPairment:QUADrature[:ANGLE]` on page 600

## 5.6.2 AWGN - Noise Generator

The noise generator generates an AWGN signal (Additive White Gaussian Noise) in the digital baseband, i.e. the noise power density has a Gaussian distribution and is distributed evenly across the frequency. This noise signal superimposes the (interference-free) useful signal ("Additive Noise" mode). Typical applications for the noise generator are bit-error or block-error measurements, depending on the set S/N or C/N ratio.

The Gaussian noise is generated by means of feedback shift registers with subsequent probability transformation. The switching configuration is such that virtually ideal statistical characteristics are achieved:

- I and Q paths are decorrelated from each other.
- The crest factor of 18 dB allows very small probabilities to be realized.
- The period of the noise signal depends on the selected system bandwidth. The relationship of period P to system bandwidth  $B_{\text{sys}}$  is approximated:

$$P \approx 1 \cdot 10^{13} / B_{\text{sys}}$$

This results in periods between 317 years with minimum bandwidth and approximately 2 days with maximum bandwidth.

This results in a period of approximately one month for 3GPP FDD with a bandwidth of 3.84 Mcps, and a period of 427 days for GSM with 270.833 ksps.

Scalable low-pass filters are used to produce a noise power with both a broad dynamic range and a broad bandwidth range (from 1 kHz to 60 MHz).

Apart from the "Additive Noise" mode, there are also the "Noise Only" and the "CW Interferer" mode. In the "Noise Only" mode a pure noise signal is generated and modulated to the carrier. In the "CW Interferer mode", a sinusoidal signal with an adjustable frequency offset to the baseband signal is generated and added to the baseband signal by means of a counter instead of a shift register.

### 5.6.2.1 AWGN Settings Dialog

To open the "AWGN Settings" menu for setting the noise generator, select "AWGN/IMP > Configure > AWGN" or use the MENU key under "AWGN/IMP".

The "AWGN Settings" menu is divided into the following sections.

The RFI signal generator is activated, the mode selected and the interfering signal is configured in the top section of the menu.

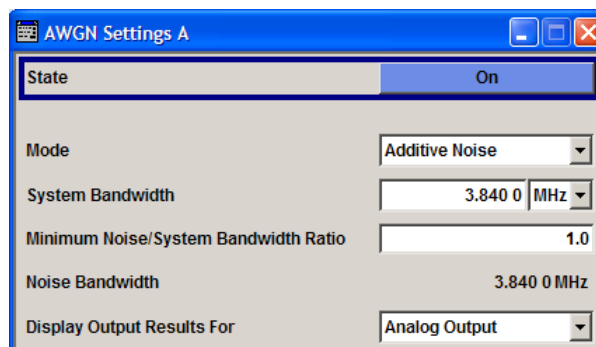

The power of the interfering signal is configured in the "Noise power Configuration And Output Results" section.

In "Additive Noise" and "CW interferer" mode, the interfering power can be defined and the resulting total power displayed here.

In "Noise Only" mode, only the noise power can be set here.

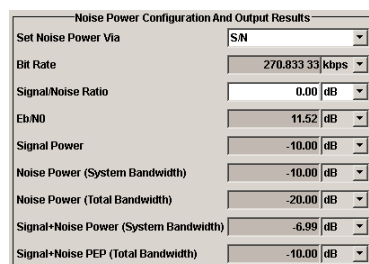

### AWGN Settings

The RFI signal generator is activated, the mode selected and the interfering signal is configured in the top section of the menu.

#### State - AWGN

Activates/deactivates the RFI signal generator. The interferer (AWGN or CW interferer, depending on the selected mode) is generated as after the generator is activated.

Remote command:

[ :SOURce<hw> ] :AWGN:STATe on page 503

#### Mode - AWGN

Selects the mode for generating the interfering signal.

"Additive Noise"

The AWGN noise signal with selectable system bandwidth is added to the baseband signal.

"Noise Only"

The pure AWGN noise signal with selectable system bandwidth is modulated to the carrier. The connection to the baseband is interrupted.

"CW Interferer"

A sine with a defined frequency offset is added to the baseband signal. The calculation of  $E_b/N_0$  ratio is omitted.

Remote command:

[ :SOURce<hw> ] :AWGN:MODE on page 499

#### System Bandwidth - AWGN

(Additive Noise and Noise Only)

Sets the RF bandwidth to which the set carrier/noise ratio relates.

Within this frequency range, the signal is superimposed with a noise signal whose power corresponds exactly to the set C/N or S/N ratio.

**Note:** The noise signal is not generated arbitrarily for a particular bandwidth, but instead it is generated in steps. Noise therefore also occurs outside the set system bandwidth.

Remote command:

[ :SOURce<hw> ] :AWGN:BWIDth on page 496

#### Minimum Noise/System Bandwidth Ratio - AWGN

(Additive Noise and Noise Only)

Sets the ratio of minimum noise bandwidth to system bandwidth.

**Note:** The noise signal is not generated arbitrarily for a particular bandwidth, but instead it is generated in steps. Noise therefore also occurs outside the set system bandwidth.

With this parameter the minimum real noise bandwidth can be set as required by some standards. It does not influence the calculation of power from the set C/N or S/N ratio in relation to system bandwidth.

The overall bandwidth is calculated as follow and may not exceed 80 MHz.

Overall Bandwidth = System BW x Minimum Noise/System BW Ratio

Remote command:

[ :SOURce<hw> ] :AWGN:BWIDth:RATio on page 497

#### Noise Bandwidth - AWGN

(Additive Noise and Noise Only)

Indicates the real noise bandwidth. The value is indicated when AWGN state is "On".

**Note:** The noise signal is not generated arbitrarily for a particular bandwidth, but instead it is generated in steps. Noise therefore also occurs outside the set system bandwidth.

Remote command:

[ :SOURce<hw> ] :AWGN:BWIDth:NOISe? on page 497

#### Display Output Results For - AWGN

(Additive Noise and Noise Only)

Selects the display of output results for the analog (DACIF) or the digital (BBOUT) signal path.

**Note:** This selection field is only available with the option R&S AMU-B18, Baseband Digital I/Q Out. If the instrument is not equipped with this option the parameters of the analog signal path are displayed.

"Analog Out-put" The parameters of the analog signal path are displayed.

"Digital Output" The parameters of the digital signal path are displayed.

Remote command:

[ :SOURce<hw> ] :AWGN:DISP:ORESults on page 497

#### Target CW Frequency - AWGN

(CW Interferer mode only)

Sets the desired frequency of the sine in "CW Interferer" mode.

Remote command:

[ :SOURce<hw> ] :AWGN:FREQuency:TARGet on page 499

#### Resulting CW Frequency - AWGN

(CW Interferer mode only)

Indication of the actual CW frequency of the sinusoidal signal in "CW Interferer" mode.

The actual frequency may differ from the desired frequency, since the resolution is limited to 0.7 Hz.

**Tip:** The desired frequency constellation can be precisely set with an accuracy of up to 0.01 Hz by selecting a suitable frequency offset of the baseband source (e.g. Custom Dig Mod) and by correcting the RF frequency by the difference between Resulting and Target CW Frequency.

Remote command:

[ :SOURce<hw> ] :AWGN:FREQuency:RESult? on page 498

### Noise Power Configuration And Output Results

The interfering signal is configured in the "Noise/Interferer Power Configuration and Output Results" section.

#### Set Power via - AWGN

(Additive Noise only)

Selects the mode for setting the noise power.

- "C/N ""S/N"      The noise power is set on the basis of the value entered for the carrier/noise or signal/noise ratio.  
With digital modulation, the associated  $E_b/N_0$  value is determined and displayed.
- " $E_b/N_0$ "      The noise power is set on the basis of the value entered for the ratio of bit energy to noise power density.  
The associated C/N or S/N value is displayed. The correlation between the two values is as follows:  
 $C/N$  or  $S/N = (E_b/N_0) \cdot (f_{bit}/B_{sys})$ , where  
 $f_{bit}$  is the Bit rate (Symbol rate x Modulation value)  
 $B_{sys}$  is the System bandwidth  
With "Custom Dig Mod" signals, the bit rate used for calculation is defined by the selected standard in the "Custom Digital Mod" dialog.  
With "Digital Standard" signals, the bit rate to be used for calculating the  $E_b/N_0$  can be entered at "Bit Rate".  
Some test cases with the 3GPP base station tests (TS 25.141) specify, for example, E/N settings that apply to channel-coded data or block segments.

Remote command:

[ :SOURce<hw> ] :AWGN:POWer:MODE on page 500

#### Bit Rate - AWGN

(Additive Noise)

Sets or indicates the bit rate used for converting C/N or S/N to  $E_b/N_0$ .

With "Custom Digital Mod" signals, the bit rate used is indicated here. It is defined by the choice of the standard in the "Custom Digital Mod" menu.

With "Digital Standard" signals, the bit rate used for converting C/N or S/N to  $E_b/N_0$  is set here.

When generating a "Digital Standard", it is thus possible to select which bit rate is to be used for calculating the ratio of bit energy to noise power density, e.g. the bit rate before or after channel coding.

Remote command:

[ :SOURce<hw> ] :AWGN:BRATe on page 496

#### Carrier/Noise Ratio / Signal/Noise Ratio

(Additive Noise and CW Interferer only)

Sets the carrier/noise, signal/noise or signal/interferer ratio.

If "Set Noise Power via  $E_b/N_0$ " is selected, the associated C/N or S/N value is displayed here.

Remote command:

`[ :SOURce<hw> ] :AWGN:SNRatio` on page 503

### $E_b/N_0$ - AWGN

(Additive Noise)

Sets the ratio of bit energy to noise power density in "Additive Noise" mode.

If "Set Noise Power via C/N or S/N" is selected, the associated  $E_b/N_0$  value is displayed here.

Remote command:

`[ :SOURce<hw> ] :AWGN:ENRatio` on page 498

### Carrier Power

(Additive Noise and CW Interferer)

Displays the power of the useful signal.

Remote command:

`[ :SOURce<hw> ] :AWGN:POWer:CARRier` on page 500

### Noise Power (System Bandwidth) / Interferer Power

(Additive Noise, Noise Only, CW Interferer)

Displays the power of the noise / interferer signal. In this mode, this value corresponds to the "Level" in the header of the instrument.

**Note:** The noise signal is not generated arbitrarily for a particular bandwidth, but instead it is generated in steps. Noise therefore also occurs outside the set system bandwidth. This means that the total measurable noise power (see below) usually exceeds the value displayed here. Correct measurement of the noise power within the system bandwidth is possible by means of channel power measurement using a signal analyzer.

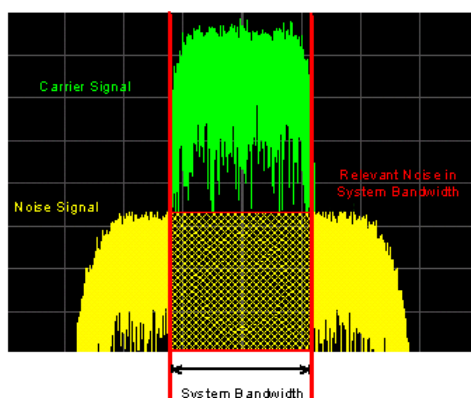

Remote command:

`[ :SOURce<hw> ] :AWGN:POWer:NOISe` on page 501

**Noise Power (Total Bandwidth) - AWGN**

Displays the power of the noise signal in the total bandwidth in "Noise Only" and "Additive Noise" mode.

Remote command:

`[ :SOURce<hw> ] :AWGN:POWer:NOISe:TOTal?` on page 501

**Carrier + Noise Power / Signal + Noise Power (System Bandwidth) / Carrier + Interferer Power / Signal + Interferer Power**

In "Additive Noise" and "CW Interferer" modes, displays the overall power of the noise/interferer signal plus useful signal.

**Tip:** In the "Additive Noise" mode, select the "Display Output Results For" (analog or digital) before.

Remote command:

`[ :SOURce<hw> ] :AWGN:POWer:SUM?` on page 502

**Carrier + Noise PEP / Signal + Noise PEP (Total Bandwidth) / Carrier + Interferer PEP / Signal + Interferer PEP**

(Additive Noise and CW Interferer)

Displays the peak envelope power of the overall signal composed of noise signal plus useful signal.

**Note:** The peak envelope power (PEP) specified in the header corresponds to the PEP value of the carrier.

In the mode "Additive Noise" the "Display Output Results For" (analog or digital) has to be set before.

Remote command:

`[ :SOURce<hw> ] :AWGN:POWer:SUM:PEP?` on page 502

**5.6.3 I/Q Level - Info...**

The signal power and the crest factor of the baseband signal at the I/Q output connectors are indicated in the dialog box "Baseband Info". This information is needed, for example, to use the I/Q signal externally and to adjust the power correctly there, or to see how the signal is modulated.



The information provided in this dialog box depends on the baseboard version your instrument is equipped with:

- Up to baseboard version *DacBoard 1141.8090.xx* the calculated values of the signal power are displayed only, as described in [Chapter 5.6.3.1, "Baseband Signal Level"](#), on page 233.
- From baseboard version *DacBoard 1141.8190.02* or higher, monitoring the measurement with or without interfering is possible. See [Chapter 5.6.3.2, "Baseband Signal Power Measurement"](#), on page 234.

To check the baseboard version of the instrument, select "Setup > System > Hardware Config, section Baseband Assembly" (see [Chapter 5.2.3.3, "Hardware Config"](#), on page 142).



To open the "Baseband Info..." dialog for information on the baseband I/Q signal during measurement, select "AWGN/IMP > Configure > I/Q Level > Info" or use the MENU key under "AWGN/IMP".

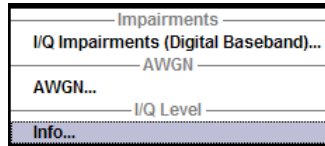

### 5.6.3.1 Baseband Signal Level



This section applies to instruments equipped with a baseboard up to version *DacBoard 1141.8090.xx*.

The signal power values and the crest factor of the baseband signal at the I/Q output connectors are displayed in the dialog.

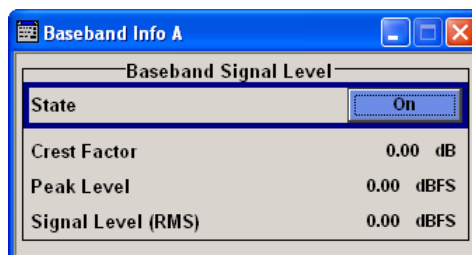

#### Crest Factor - Digital Impairments

Indicates the crest factor of the baseband signal.

The crest factor is calculated from the two level parameters as follows:

$$\text{Crest[dB]} = \text{Peak\_Power[dBFs]} / \text{Signal\_Power[dBFs]}$$

Remote command:

`[ :SOURce<hw> ] :BB:CFACTOR?` on page 625

#### Peak Power - Digital Impairments

Indicates the peak power of the baseband signal relative to full scale of 0.5 V (in terms of dB full scale).

Remote command:

`[ :SOURce<hw> ] :BB:POWer:PEAK?` on page 625

#### Power - Digital Impairments

Indicates the power of the baseband signal relative to full scale of 0.5 V (in terms of dB full scale).

Remote command:

`[ :SOURce<hw> ] :BB:POWer:RMS?` on page 626

### 5.6.3.2 Baseband Signal Power Measurement



This section applies to instruments equipped with a baseboard version *DacBoard 1141.8090.xx* or higher.

The power measurement of the I/Q baseband signal is monitored and displayed in the dialog. The measurement can be performed either with or without interfering.

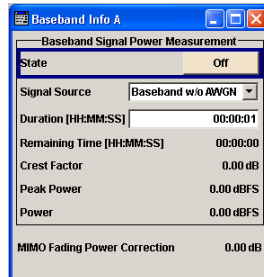

#### State - Digital Impairments - Measurement

Activates the measurement of the digital I/Q baseband signal.

When activated, information on the peak power, power and crest factor are indicated. Additionally the duration of the measurement can be set.

Remote command:

`[ :SOURce<hw> ] :BB:MEASurement [ :STATe ]` on page 624

#### Signal Source - Digital Impairments - Measurement

Selects the signal for the measurement. The power and crest factor can be retrieved either from the interference-free digital I/Q baseband signal or the signal superimposed by the noise generator AWGN.

"Baseband w/o AWGN" Activates the measurement of the interference-free baseband signal.

"Baseband with AWGN" Activates the measurement of the baseband signal after an AWGN noise signal is added.

Remote command:

`[ :SOURce<hw> ] :BB:MEASurement :SOURce` on page 623

#### Duration - Digital Impairments - Measurement

Enters the time for the measurement of the digital I/Q baseband signal in the range of 1 s ... 3 h. The time is to be entered in format "hh:mm:ss".

Remote command:

`[ :SOURce<hw> ] :BB:MEASurement :DURation` on page 622

#### Remaining Time - Digital Impairments - Measurement

Indicates the remaining time until the measurement of the digital I/Q baseband signal is completed. The time is displayed in format "hh:mm:ss".

Remote command:

`[ :SOURce<hw> ] :BB:MEASurement:RTIME?` on page 623

#### **Crest Factor - Digital Impairments - Measurement**

Indicates the crest factor of the baseband signal during measurement.

Remote command:

`[ :SOURce<hw> ] :BB:MEASurement:CFACTOR?` on page 621

#### **Peak Power - Digital Impairments - Measurement**

Indicates the peak power of the baseband signal relative to full scale of 0.5 V (in terms of dB full scale) during measurement.

Remote command:

`[ :SOURce<hw> ] :BB:MEASurement:POWer:PEAK?` on page 622

#### **Power - Digital Impairments - Measurement**

Indicates the power of the baseband signal relative to full scale of 0.5 V (in terms of dB full scale) during measurement.

Remote command:

`[ :SOURce<hw> ] :BB:MEASurement:POWer:RMS?` on page 623

#### **MIMO Fading Power Correction - Digital Impairments - Measurement**

The MIMO Fading Power Correction represents the relative power offset of the selected path compared to the power level of the other path.

The resulting power level of the selected path is then the RF level displayed on the header of the instrument reduced by the MIMO Fading Power Correction value.

The MIMO Fading Power Correction is necessary in case a MIMO Fading mode with unequal steering matrix's elements is selected in the "Fading" block (see section "Multiple Input Multiple Output" in the description "Fading Simulator"). Such a steering matrix is used to simulate antennas with different power level.

While working in a 4x2 or 3x2 MIMO mode that requires two two-path instruments, the MIMO Fading Power Correction for path A of both instruments is identical and respectively this correction coefficient is identical for both B paths.

However, for two instruments connected and configured to simulate a 2x4 or 2x3 MIMO configurations, there are individual MIMO Fading Power Correction coefficients for each path and the resulting power level of each of the paths has to be calculated separately.

Remote command:

`[ :SOURce<hw> ] :BB:MFPCorrection?` on page 624

## **5.7 Baseband Signal - Baseband Block**

The R&S AMU provides you with the ability to generate digital modulation signals in accordance with the definitions in the digital standards or with user-definable characteristics. Signals are generated in realtime or from a data store with the aid of external

and internal data. You can also load externally computed modulation signals into the R&S AMU in the form of waveform files.

Several digital standards are provided, plus digital modulation with user-definable signal characteristics, generation of waveforms with the aid of the Arbitrary Waveform Generator and generation of multi carrier CW signals with the aid of Multi Carrier CW.

The settings for digital modulation can be accessed in the block diagram via the "Baseband" function block or with the aid of the MENU key.

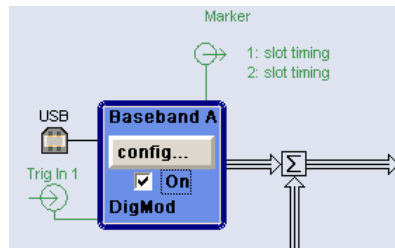

The equipment layout for generating the internal, digital modulation signals includes the options Baseband Main Module (B13) and one of the options Baseband Generator (B9/B10/B11). The three Baseband Generator options feature different ARB memory sizes (see data sheet). Apart from the memory size, however, the options offer the same functionality, either one can be installed.

In addition, the appropriate option is required for the digital standards. These options are specified in the description of the respective standard.

The minimum equipment for a two-path instrument is a second R&S AMU-B9/B10/B11 option. This can be used simultaneously on the second path to generate a modulation signal which can either be routed via path A or added to the signal on path A with a frequency offset that can be set. In the case of a fully two-path layout, path B can be operated as a second signal generator independently of path A (see also data sheet).

If the appropriate options are fitted, externally supplied real-time baseband signals can be added to the internally generated signals.

In the subsequent signal route the baseband signals can be frequency-shifted, faded, detuned or loaded with noise (see [Chapter 5.8, "External Baseband Signal - Baseband Input"](#), on page 367, [Chapter 5.6, "Impairment of Digital I/Q Signal and Noise Generator - AWGN/IMP Block"](#), on page 222 and the description "Fading Simulator").

### 5.7.1 Working with the Baseband Signal

Frequency Offset	0.00 Hz
Phase Offset	0.0 deg
Path Gain	0.0 dB
Signal Routing	<input checked="" type="checkbox"/> route to path A <input type="checkbox"/> route to path B <input type="checkbox"/> route to path A and B

In the case of two-path instruments, signal routing, frequency offset and path gain definition are defined at the topmost menu level in the "Baseband" block or by using the MENU button under "Baseband".

The upper part of the "Baseband" dialog is used for selecting digital standards, digital modulation and waveform generation. These menus are described in the respective chapters relating to the modulation systems.

The lower part of the "Baseband" dialog can be used to define a frequency offset a path gain, a phase offset, and the signal routing for two-path instruments.

**Frequency Offset**

Enters the frequency offset for the baseband signal.

The offset affects the signal on the Baseband block output. It shifts the useful baseband signal in the center frequency



Wenn a frequency offset is defined, an icon is displayed in the signal flow right to the baseband block.

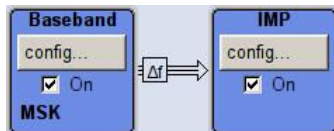

**Note:** A frequency offset cannot be applied to external or internal signals with sample rates of exactly 100 MHz. The digital signal is fed into the signal path directly and not routed to the resampler where the frequency offset is performed.

The complex I/Q bandwidth of the shifted useful signal must not exceed the total available baseband bandwidth (see data sheet). The setting range of the frequency offset is then calculated as follow:

$$-(TotalBasebandBandwidth/2) + f_{use}/2 \leq f_{offset} \leq (TotalBasebandBandwidth/2) - f_{use}/2 ,$$

where

$f_{use}$  is the complex useful bandwidth of the I/Q signal before the offset

$f_{offset}$  is the frequency offset

The [Figure 5-14](#) illustrates the setting range for the frequency offset.

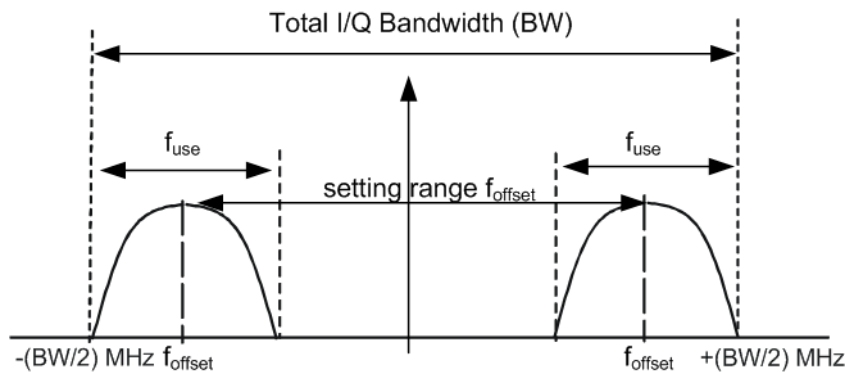
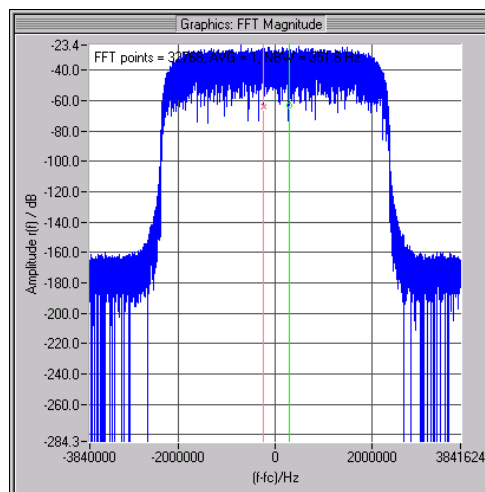

Figure 5-14: Setting range for frequency offset

**Example: Calculating the maximum frequency offset**

This example uses the following signal:

- "Standard = 3GPP FDD"
- "Chip Rate = 3.84 Mcps"
- "Filter Type = Root Cosine"
- "Roll Off Factor = 0.22"



**Figure 5-15: 3GPP FDD signal (chip rate 3.84 Mcps, root-cosine filter 0.22).**

The complex useful bandwidth of filtered signal is calculated as follows:

$$f_{use} = (1 + \text{"Roll Off Factor"}) * \text{"Symbol Rate"}$$

$$f_{use} = (1 + 0.22) * 3.84 \text{ MHz} = 4.6848 \text{ MHz}$$

For instrument with a total available I/Q bandwidth of 80 MHz, the valid range of values for the frequency offset is then:

$$-80\text{MHz}/2 + 4.6848\text{MHz}/2 \leq f_{offset} \leq 80\text{MHz}/2 - 4.6848\text{MHz}/2 \text{ or}$$

$$-37.6576\text{MHz} \leq f_{offset} \leq 37.6576\text{MHz}$$

Remote command:

`[ :SOURce<hw> ] :BB:Foffset` on page 505

**Phase Offset**

Enters the phase offset for the baseband signal of the selected path compared to the baseband signal of the other path.



For instruments equipped with an external baseband input ("BB Input"), this parameter also enters the phase offset of the baseband signal of the selected path compared to the external baseband input.

A phase offset rotates each point of an I/Q constellation diagram by the specified phase offset. The phase offset affects the signal on the "Baseband block" output.

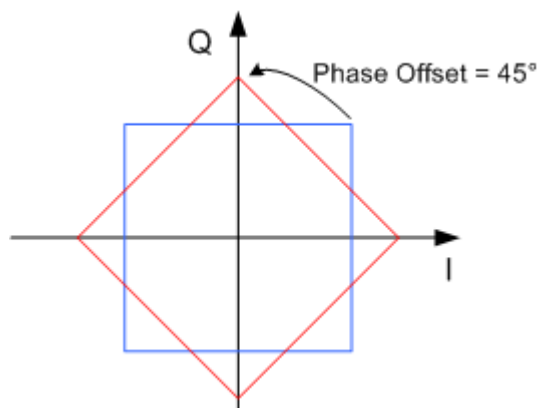

Figure 5-16: Effect of a Phase Offset of 45 degree angle on the I/Q constellation diagram

Observe that the points on the I/Q constellation diagram are turning counterclockwise.

Remote command:

`[ :SOURce<hw> ] :BB:POFFset` on page 505

### Path Gain

Enters the path gain for the baseband signal of the selected path compared to the baseband signal of the other path.

In case an external baseband input ("BB Input") is used, this parameter also determines the path gain for the baseband signal of the selected path compared to the baseband signal of this external data source.

The gain affects the signal on the "Baseband block" output.

**Note:** In case the baseband signal is additionally faded and routed at the output of the fading simulator, so that the faded signals from both paths are summed, the real path gain is measured at the output of the "Fading" block and set with the fading parameter "Summation Ratio A/B" (see description "Fading Simulator", section "Summation Ratio A/B").

The relative gain set with the parameter "Path Gain" in the "Baseband" block is ignored.

The "Path Gain" of the different baseband sources define the relative gain of the associated signals. The real gain depends on the following parameters along with the set path gain:

- Signal characteristics, in particular the crest factor
- Number of baseband sources

The sum baseband signal can be verified in the spectrum display in the "Graphics" block.

Remote command:

`[ :SOURce<hw> ] :BB:PGain` on page 505

### Signal Routing

Selects the signal route for the baseband signal of a two-path instrument.

The following table shows the combination of signal routes allowed for two-path instruments.

Table 5-3: Combinations of signal routings for two-path instruments

Routing baseband A	Routing baseband B	Block diagram
Route to path A	Route to path A	
Route to path A	Route to path B	
Route to path A	Route to path A and B	
Route to path B	Route to path A	
Route to path B	Route to path B	



Baseband Signal - Baseband Block

Routing baseband A	Routing baseband B	Block diagram
Route to path B	Route to path A and B	
Route to path A and B	Route to path A	
Route to path A and B	Route to path B	
Route to path A and B	Route to path A and B	

"Route to path A"

The baseband signal is introduced into path A. The signals from both paths are summed if necessary.

"Route to path B"

The baseband signal is introduced into path B. The signals from both paths are summed if necessary.

"Route to path A and B"

The baseband signal is introduced into path A and path B. The signals from both paths are summed if necessary.

Remote command:

[ :SOURce ] :BB:PATH:COUNT? on page 504

[ :SOURce<hw> ] :BB:ROUTE on page 506

## 5.7.2 Data and Signal Sources in Baseband

This section describes the common characteristics of the signals used for generating the baseband signal for all standards, including for example all listed data sources. The selection in the digital menus at any given time depends on the parameter and standard concerned and is clear from the selection list offered in the dialog. The external data sources may therefore not be available in certain cases.

Characteristics which are uniquely specific to particular standards are described in the corresponding manual.

For instruments equipped with option Baseband Input, R&S AMU-B17, externally generated analog baseband signals can be fed into the digital signal path via the analog I/Q input "I IN" and "Q IN".

The following input signals are used when digital modulation signals are being generated:

- Modulation data
- Clock signals
- Control signals

The input signals can be both internally generated and supplied from an external source. The internally generated data and clock signals are output not only on the DATA and CLOCK connectors but also on the corresponding pins of the AUX I/O interface.

In the case of two-path instruments, the external data and clock sources are permanently allocated to path A, and data output is always for path A.

Clock signals for both paths can be internally generated or supplied from an external source. When the external clock source is selected, the externally supplied clock signal always applies to both paths simultaneously.

Likewise control signals and also trigger signals for triggering signal generation in the R&S AMU can be internally generated or supplied from an external source.

Up to four marker output signals for synchronizing external instruments can be user-defined for each path.

Externally computed waveform files can be loaded in the instrument using computer interfaces or IEC bus.

Waveform files are processed with the aid of the Arbitrary Waveform Generator (ARB), see [Chapter 5.7.4, "Arbitrary Waveform Generator ARB"](#), on page 296.

Internally the "Multi Carrier CW" menu for defining multi carrier waveforms is available (see [Chapter 5.7.5, "Multi Carrier Continuous Wave"](#), on page 354).

### 5.7.2.1 Internal PRBS Data and Data Patterns

PRBS generators deliver pseudo-random binary sequences of differing length and duration. They are known as maximum length sequences, and are generated with the aid of ring shift registers with feedback points determined by the polynomial.

By way of example, the diagram below shows a 9-bit generator with feedback to registers 4 and 0 (output).

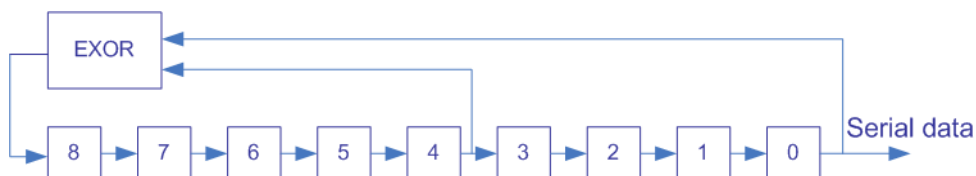
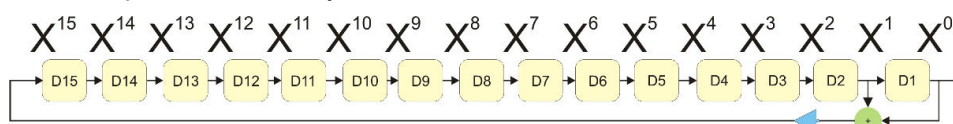

Figure 5-17: 9-bit PRBS generator



For PRBS15 and PRBS23, a CCITT V.52-compliant data inversion is performed in the feedback path automatically as shown below:



The pseudo-random sequence from a PRBS generator is uniquely defined by the register number and the feedback. The following table describes the available PRBS generators:

Table 5-4: PRBS generators

PRBS generator	Length in bits	Feedback to	GUI selection
9-bit	$2^9 - 1 = 511$	Registers 4, 0	PRBS 9
11-bit	$2^{11} - 1 = 2047$	Registers 2, 0	PRBS 11
16-bit	$2^{16} - 1 = 65535$	Registers 5, 3, 2, 0	PRBS 16
20-bit	$2^{20} - 1 = 1048575$	Registers 3, 0	PRBS 20
21-bit	$2^{21} - 1 = 2097151$	Registers 2, 0	PRBS 21

The "Data Source" selection for PRBS data from the dialog is "PN11, ...".

Simple data patterns such as binary 0 strings or 1 strings can also be used as internal modulation data. The "Data Source" selection from the menus is "ALL 0", "ALL 1". A variable bit string with a maximum length of 64 bits can be entered in an input field by selecting "Pattern."

### 5.7.2.2 Internal Modulation Data from Lists

Internal modulation data can be generated and stored in the form of binary lists. A separate file is created for each list and held on the instrument's hard disk.

The file name can be defined by the user.

The "Data Source" selection from the menus is "Data List". When this menu item is chosen the "Select Data List" button appears; this opens the file-selection window for data lists. A list can be created and edited in the "Data List Editor", which is accessed from the menu via the "List Management" or "Data List Management" button.

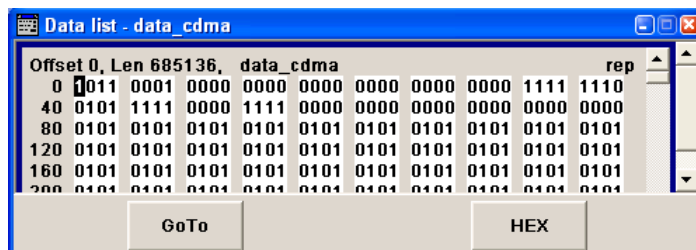

The maximum length of a data list is determined by the size of the data list memory (see data sheet). There is no restriction on the number of lists that can be stored.

### 5.7.2.3 External Synchronous Modulation Data

#### External Serial Modulation Data via the DATA Connector

For "Custom Digital Modulation", serial modulation data can be supplied bit-by-bit via the DATA connector. The "Data Source" selection from the menu is "Extern Serial".

In the case of two-path instruments the DATA input is permanently allocated to path A.

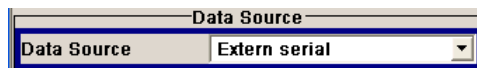

In the case of modulation modes with more than 1bit/symbol, the most significant bit (MSB) must be fed in first (MSB first).

The clock reference (symbol clock) used to read in the data can be either internal or external.

External serial data is output on the PARDATA pins of the AUX I/O interface as parallel data LSB-justified.

The maximum data rate for serial data processing can be found in the data sheet.

#### External Parallel Modulation Data via the AUX I/O Interface

For "Custom Digital Modulation", parallel data can be supplied symbol-by-symbol via the AUX I/O interface (D0 – D9). The "Data Source" selection from the menu is "Extern Parallel".

In the case of two-path instruments the data lines from the AUX I/O interface are allocated to pathA permanently.



In the case of modulation modes with fewer than 10bits/symbol, the data must be applied LSB-justified. In the case of 8-PSK modulation for example (3bits/symbol) only data lines D0, D1 and D2 are used.

The clock reference (symbol clock) used to read in the data can be either internal or external.

External parallel data is output on the DATA connector serially. However, there is a maximum data rate above which serial data processing becomes impossible and the DATA connector becomes high-impedance. The maximum data rate for parallel data processing is shown in the data sheet.

#### 5.7.2.4 Clock Signals

The clock reference used for generating the timing pulse can be either internal or external ("Clock Source" selection from the menu: "Internal / External").

##### Internal clock reference



The table below gives an overview of the generated clock signals and the connectors they are output at for the case a internal clock reference is selected.

Connector	Location	Clock Mode
CLOCK	front panel	Symbol clock
CLOCK OUT	rear panel	Choice of bit clock or symbol clock
BITCLK	AUX I/O interface, rear panel	Bit clock
SYMBCLK	AUX I/O interface, rear panel	Symbol clock

If required, in the case of two-path instruments the internal bit clock or symbol clock from path B can be output on one of the USER interfaces.

The clock output signals are assigned in the menu sequence "Setup > Environment > Global Trigger/Clock/External Inputs > USER Marker /AUX I/O Settings".

##### External clock reference

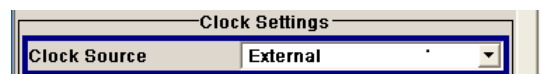

An external clock is always supplied via the CLOCK connector. When the external clock reference is selected, the internal clock is synchronized to it. The table below gives an overview of the connectors the internal clocks are output at.

Connector	Location	Clock Mode
CLOCK OUT	rear panel	Choice of bit clock or symbol clock
BITCLK	AUX I/O interface, rear panel	Bit clock
SYMBCLK	AUX I/O interface, rear panel	Symbol clock

The active edge of the external clock signal on the CLOCK input is selectable (menu "Setup > System > Global Trigger/Clock/External Inputs"). Internally the rising edge is always taken as the active edge. The active rising edge of the internal clocks is therefore synchronized with either the rising or the falling edge of the external clock reference. A symbol clock can be supplied externally or, if internally generated or externally asynchronous data is being fed in, a multiple of a symbol clock can be supplied.

In the case of two-path instruments the external clock signal is applied to path A.

In order for the clock synthesizer on the R&S AMU to be synchronized correctly, the external clock reference must first be applied and the correct symbol rate must then be set. Until this has been done the external clock source must not be selected ("Clock Source External").



The symbol rate set must not deviate from the symbol rate of the external signal by more than 2% (see also data sheet).

The synchronization of data signals and clock signals for the various data sources and clock sources is described in [Chapter 5.7.2.5, "Synchronizing Data Signals and Clock Signals"](#), on page 246.

### 5.7.2.5 Synchronizing Data Signals and Clock Signals

When selecting data signals and clock signals, the following operating modes are possible:

- Internal clock and internal data
- Internal clock and external synchronous data
- External clock and external synchronous data
- External clock and either internal data or external asynchronous data

#### Internal Clock and Internal Data

In modulation modes with fewer than 10bits/symbol, the parallel data is output LSB-justified. In the case of 8-PSK modulation for example (3bits/symbol) only data lines D0, D1 and D2 are used.

In the following example, the diagram shows the output signals of an 8-PSK modulation (3 bits per symbol) on the serial DATA interface. The positive edge of the clock is always used when outputting data. The data source is a data list with 15 bits = 001 010 100 101 110 (5 symbols).

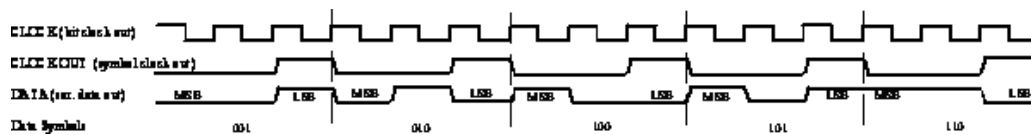

Figure 5-18: Output signal on the serial data interface and clock output signals on the AUX I/O interface

There is a maximum data rate above which serial data processing becomes impossible. This data rate can be found in the data sheet. If the rate is exceeded the DATA connector becomes high-impedance, and the output on the CLOCK connector is the symbol clock instead of the bit clock.

In the following example, the diagram shows the output signals of an 8-PSK modulation (3 bits per symbol) on the parallel interface. The data source is a data list with 15 bits = 001 010 100 101 110 (5 symbols).

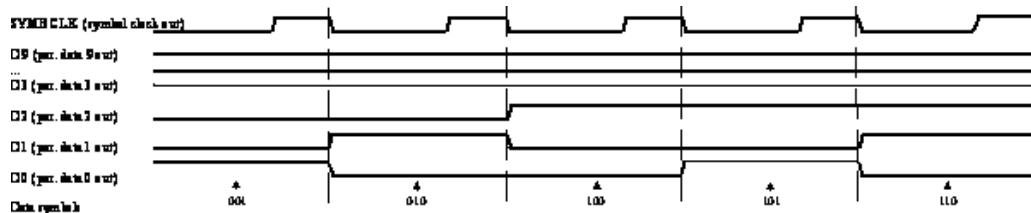

Figure 5-19: Data and clock output signals on the parallel AUX I/O interface

In order for parallel external data to be retrieved correctly the rising edge of the symbol clock must be used, since the timing between the falling edge of the symbol clock and the data switch on the parallel interface is undefined.

**Internal Clock and External Synchronous Data**

**External serial data**

When serial data for "Custom Digital Modulation" is being fed in via the DATA connector on the front panel, the symbol clock acts as a scanning pulse (strobe) so as to mark the least significant bit in a symbol.

The clock signals are output on the CLOCK and CLOCK OUT connectors (front panel and rear panel respectively, choice of bit clock or symbol clock on the latter) and on the BITCLK or SYMBCLK pins on the AUX I/O interface. Optimum timing is achieved from using the output signal on the CLOCK connector on the front panel. The setup and hold times (see following diagram, tsetup and thold) that must be maintained in the R&S AMU to ensure that the serial data is accepted correctly can be found in the data sheet.

The following diagram illustrates the timing ratios between data and clock when serial data is being supplied from an external source and the internal clock source is being used.

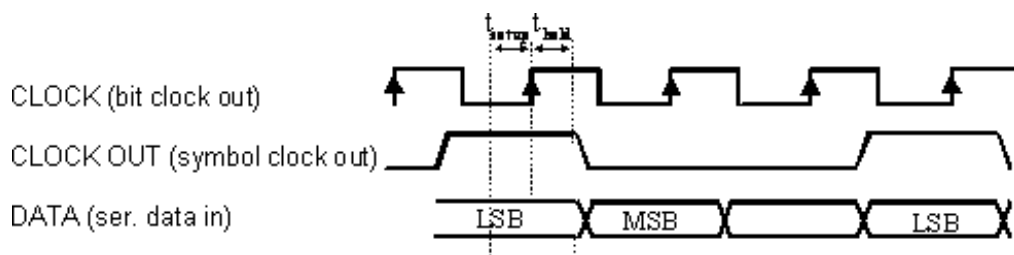

**Figure 5-20:** External serial data and the clock signals which are output (bit clock and symbol clock). The setup time ( $t_{\text{setup}}$ ) and hold time ( $t_{\text{hold}}$ ) can be found in the data sheet.

### External parallel data

When parallel data for "Custom Digital Modulation" is being fed in via the AUX I/O interface (D0 – D9), the internal symbol clock is used.

The symbol clock is output on the CLOCK OUT connector (rear panel, choice of bit clock or symbol clock) and on the SYMBCLK pin on the AUX I/O interface. Optimum timing is achieved by using the symbol clock on the SYMBCLK pin on the AUX I/O interface. The setup and hold times (see following diagram,  $t_{\text{setup}}$  and  $t_{\text{hold}}$ ) that must be maintained in the R&S AMU to ensure that the serial data is accepted correctly can be found in the data sheet.

The following diagram illustrates the timing ratios between data and clock when parallel data is being supplied from an external source and the internal clock source is being used.

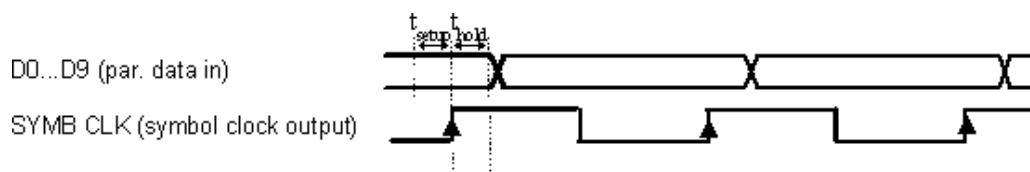

**Figure 5-21:** External parallel data, internal clock signal and the clock signal that is output on the AUX I/O interface. The setup time ( $t_{\text{setup}}$ ) and hold time ( $t_{\text{hold}}$ ) can be found in the data sheet.

### External Clock and External Synchronous Data

When synchronous modulation data is being fed in from an external source for "Custom Digital Modulation", clock generation in the R&S AMU can be synchronized on the rising or falling edge of an external symbol clock. The clock reference is supplied on the CLOCK connector (front panel).

The clock signals generated as a result are output on the CLOCK OUT connector (rear panel, choice of bit clock or symbol clock) and on the BITCLK or SYMBCLK pins on the AUX I/O interface.

### External serial data

The following diagram illustrates the timing ratios between data and clock when serial data is being supplied from an external source and an external reference clock is being used.



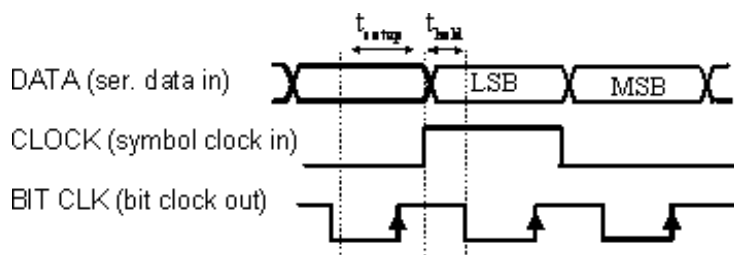
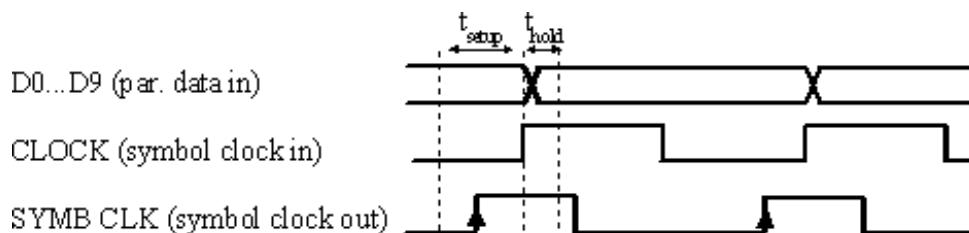

**Figure 5-22: External serial data and external symbol clock - 3 bits/symbol with high and low active symbol clock for marking the LSB. The data and the symbol clock must change state simultaneously. The setup time ( $t_{setup}$ ) and hold time ( $t_{hold}$ ) can be found in the data sheet.**

A bit clock is generated from the externally supplied symbol clock and is used for reading the serial data into the R&S AMU. The active edge of this bit clock is located ahead of the symbol clock.

#### External parallel data

The following diagram illustrates the timing ratios between data and clock when parallel data is being supplied from an external source and an external reference clock is being used.



**Figure 5-23: External parallel data with high and low active external symbol clock. The setup time ( $t_{setup}$ ) and hold time ( $t_{hold}$ ) can be found in the data sheet.**

The R&S AMU uses the externally supplied symbol clock to generate an internal symbol clock that defines the sampling points at which the parallel data is read into the R&S AMU. These sampling points are also located a little ahead of the external symbol clock.

#### External Clock and Internal or External Asynchronous Data

If the modulation data is generated internally or supplied asynchronously from an external source, clock generation in the R&S AMU can be synchronized on an external symbol clock, or a multiple thereof, which is fed in on the CLOCK connector (front panel). Synchronization can be based on the rising edge or falling edge according to choice. The maximum permissible multiple symbol clock can be found in the data sheet.

#### 5.7.2.6 Control Signals

The following control signals are processed in the R&S AMU:

- "Burst Gate" for power ramping

- "Level Attenuation" for power ramping
- "CW" for controlling the CW (continuous wave) mode

A dedicated internal "Control Data Editor" is provided for defining the control signals. Refer to "[Control and Marker List Editor](#)" on page 283 for a description on the provided settings.

A separate file with the file extension \*.dm\_iqc is created for each defined control signal and held on the instrument's hard disk.

### Continuous Wave Mode

The "CW" signal turns off digital modulation. The signal is output in unmodulated form.

In case of standards in which it is possible to switch between different modulation modes, the signal is output only and cannot be supplied from an external source. In such cases it indicates the modulation mode internally (standard GSM: signal high (1) = modulation mode GMSK and signal low (0) = modulation mode 8PSK EDGE).

The CW control signal is generated internally and fed to the AUX I/O interface. The control signals for power ramping can be provided externally for Custom Digital Modulation only. When generated internally the signals are output on the AUX I/O interface.

### Power Ramping and Level Attenuation

The R&S AMU uses the two control signals "Burst Gate" and "Lev\_Att" to trigger the power ramping and level attenuation functions.

The instrument internally generates control signals as configured in [Control and Marker List Editor](#).

If "Custom Digital Modulation" is used, you can also supply the control signals from an external source via the AUX I/O interface.

- *Burst gate control signal*  
The "Burst Gate" signal is a rectangular pulse signal with variable low and high periods. Signal generation is restricted to the gate high periods. If the power ramping function is enabled, each transition between two gate periods of the "Burst Gate" signal triggers the generation of a ramp. Further settings define the form and the steepness of this ramp, see "[Impact of the Power Ramping Settings on the Generated Signal](#)" on page 251.
- *Level attenuation control signal*  
The "Lev\_Att" signal is a rectangular pulse signal with variable low and high periods. Level attenuation is applied, if the "Lev\_Att" signal is high. If level attenuation is enabled, the modulation signal level is attenuated by a defined value.

Refer to "[Power Ramp Control](#)" on page 287 for a description of the provided settings for level attenuation and power ramping.



### Possible applications

- Use the "Level Attenuation" function to simulate radio stations located at various distances.
- Use the "Power Ramp" function if it is necessary to control the RF output signal envelope synchronously, e.g. by the generation of TDMA signals.

Both the GSM/EDGE and the TD-SCDMA firmware options are equipped with embedded power ramping function. In the GSM/EDGE standard for example, a maximum of 7 different level attenuation values can be defined and allocated separately to the 8 slots independently of one another.

### Impact of the Power Ramping Settings on the Generated Signal

The [Figure 5-24](#) explains the power ramping function in principle. The "Burst Gate" signal defines the start of the rising and falling edges of the envelope of the output signal, and the "Lev Att" signal defines the start and end of level attenuation. The signal level during the attenuation period is a configurable value.

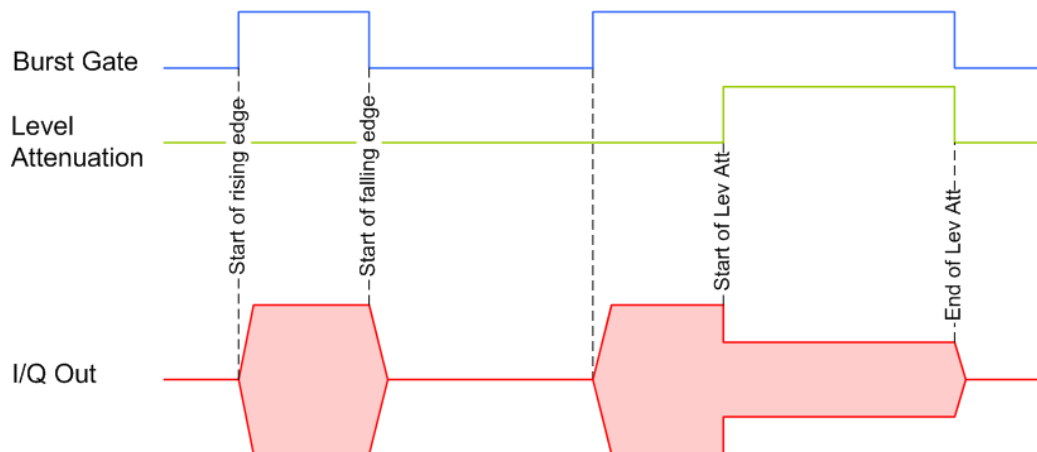

**Figure 5-24: Signal behavior when power ramping and level attenuation are enabled**

Several parameters are provided for precise definition of the form and the steepness of ramp. The [Figure 5-25](#) depicts the impact of the provided settings.

- Ramp function: defines the shape of the rising and falling edges
- Ramp time: defines the duration of the rising and the falling ramp
- Rise/fall delay: offsets the falling edge of the envelope at the beginning/end of a burst

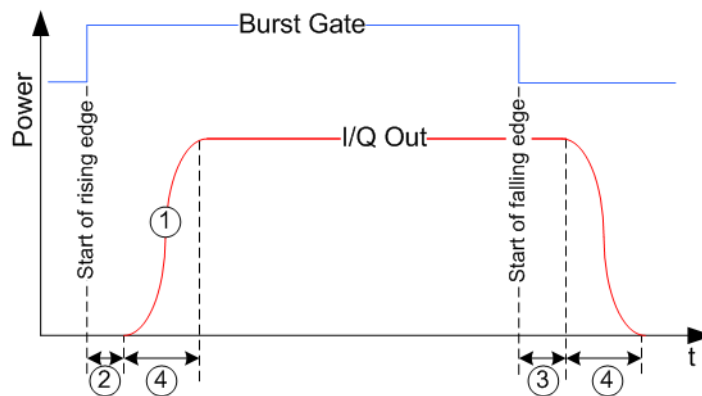

Figure 5-25: Impact of the ramp settings

- 1 = "Ramp Function"
- 2, 3 = "Rise Delay", "Fall Delay"
- 4 = "Ramp Time"

### 5.7.2.7 Trigger Signals

In the R&S AMU, trigger signals are internally generated or externally supplied signals which start signal generation at a particular point in time.

Signal generation can also take place without triggering, in which case the signal is then generated in full after modulation is powered up. A trigger event either has no effect on signal generation (menu setting "Trigger Mode Auto") or triggers a signal restart (menu setting "Trigger Mode Retrigger").

If signal generation is triggered, the signal is continuously generated after the first trigger. In the "Armed\_Auto" mode, a further trigger event has no effect. In the "Armed\_Retrig" mode, every additional trigger event triggers a restart of the signal. In both cases, triggering can be reset to the initial state ("armed"), i.e. signal generation is stopped and the instrument waits for the next trigger to start signal generation anew.

The status of signal generation ("Running" or "Stopped") is displayed for all trigger modes in the corresponding trigger menu of the digital standard currently switched on. The signal generation status particularly with an external trigger can thus be checked.

Internal and external trigger sources are available for triggering.

- Internally, triggering is carried out manually by pressing the "Execute Trigger" button (menu selection "Internal").
- In the case of two-path instruments, internal triggering can be caused by the trigger signal on the second path (menu selection "Internal (Baseband A/B)"). This makes it possible to synchronize the signal on one of the two paths with the signal on the second path. Using an external trigger source, it is possible to set the trigger signal to be delayed or suppressed.
- External trigger signals can be fed in via the TRIGGER connector (menu selection "External").

In the case of external triggering and internal triggering by the trigger signal on the second path, the start can be delayed by a definable number of symbols (menu setting "Trigger Delay External"). This makes it possible to purposely simulate the

time delay between a base station signal and a user equipment signal, for example in the course of base station tests.

The effect of a restarted trigger signal in the "Retrigger" trigger mode can be suppressed for a definable number of symbols (menu setting "External Trigger Inhibit"). By this means the trigger can be suppressed for a definable number of frames, for example in the course of base station tests, and yet the signal can still be generated synchronously. In each frame the base station generates a trigger which would cause a signal generation restart every time but for the suppression.

#### Example:

Entering 1000 samples means that after a trigger event, any subsequent trigger signal is ignored for the space of 1000 samples.

A signal which marks the trigger event set off by the current internal or external trigger of path A or B can be output at the USER connectors (AUX IO interface or USER BNC connector).



The trigger mode setting, the selection of the trigger source and the setting of a delay and trigger suppression in the case of external triggering are carried out independently for each of the two paths. On the other hand configuration of the trigger connectors (polarity and impedance) is carried out jointly for both paths.

#### 5.7.2.8 Marker Output Signals

The R&S AMU generates user-definable marker output signals which can be used to synchronize external instruments. By this means a slot clock or frame clock can be set, for instance, or the start of a particular modulation symbol can be marked.

Four marker outputs are available for each path. The outputs for markers 1 to 3 are defined, but marker 4 can be mapped to one of the USER outputs according to choice.

Path	Marker	Connector	Location
Path A	Markers 1/2	MARKER 1A / 2A BNC connectors	front panel
	Marker 3	MARKER 3A pin of the AUX I/O connector	rear panel
	Marker 4	USER1 BNC connector or USER2/3/4 pins of the AUX I/O connector	rear panel
Path B	Marker 1	MARKER 1B / 2B BNC connector	rear panel
	Markers 2/3	MARKER 3B pin of the AUX I/O connector	rear panel
	Marker 4	USER1 BNC connector or USER2/3/4 pins of the AUX I/O connector	rear panel

## Marker Modes

### Marker Mode Restart

The generated marker signal is a single "On" pulse. The rising edge of this pulse is generated at the signal generation start as well as at each subsequent signal restart time. This marker can be used to monitor the effects of the selected trigger, e.g. trigger causing restarts of the signal generation.

### Marker Mode Pulse

Periodic marker with consecutive On and Off periods of equal length. The first On period starts at the beginning of the first generated sample/symbol. The marker frequency is defined by a "Divider". The frequency is derived as follows:

<Frequency> = "Symbol/Sample Rate" / "Divider", respectively

<Frequency> = "Sampling Frequency" / "Divider".

#### Example:

Symbol Rate = 1 Msym/s, Divider = 2

The marker frequency is 500 kHz, corresponding to a marker period of 2 us. Each On and Off period has a length of 1 us, corresponding to one symbol period. With a divider of 4 (6, 8 ...), the length of each On and Off period is increased to 2 (3, 4, ...) symbol periods.

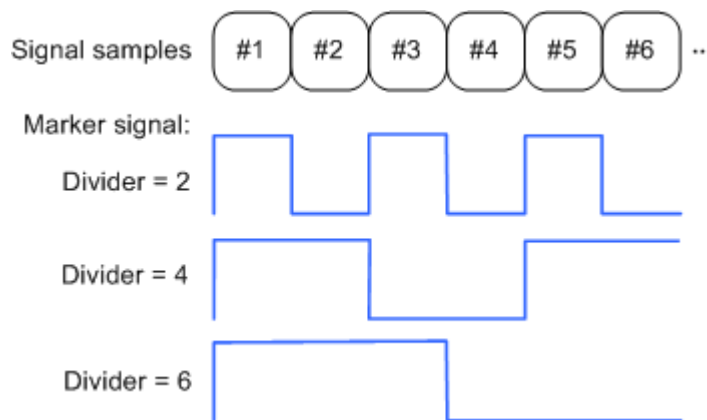

### Marker Mode Pattern

Periodic marker where each period is defined by a bit pattern with a maximum length of 64 bits. A "1" ("0") in the pattern denotes an On (Off) signal segment with a duration of one sample/symbol period.

**Example:**

In the following example, the marker signal is defined by a pattern 100100...

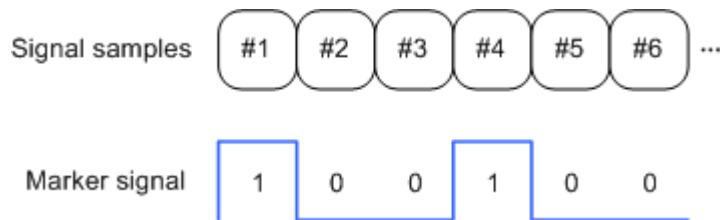
**Marker Mode ON/OFF Ratio**

Similar to "Pulse" but with independent lengths of the On and Off periods. The length of the periods is entered as a number of symbols/sample periods.

**Example:**

In the following example, the marker signal is defined by an "On Time" = 1 and "Off Time" = 2.

**5.7.3 Digital Modulation - Custom Digital Modulation**

The R&S AMU can generate digital modulation signals with user-definable characteristics. Baseband filtering and the symbol rate can be set within wide limits.

**5.7.3.1 Overview and Required Options**

The equipment layout for generating the digital modulation signals includes the options Baseband Main Module (R&S AMU-B13) and Baseband Generator (R&S AMU-B9/B10/B11).

When path B is fully expanded with a second option Baseband Main Module (R&S AMU-B13) the analog modulation signal can be output on I/Q Out B.



The differential output of the baseband signal in two-path instruments requires a second option R&S AMU-B16, Differential I/Q Out and, for digital output a second option R&S AMU-B18, Digital I/Q Out respectively.

When modulation is ON, a two-part level indication is shown in the header section of the display. This displays both the average power (LEVEL) and the peak envelope power (PEP) of the modulated output signal.

A two-part level indication is shown in the header section of the display. This displays both the rms voltage (Level) and the peak envelope power (PEP) of the output signal.

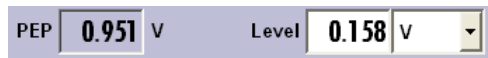

The difference between PEP and LEVEL depends on the modulation type and the filtering: Both values are pre-measured internally so that the displayed values match the true values in the signal. When external signals are used, they are replaced by PRBS data during pre-measurement.

### 5.7.3.2 Modulation Types - Custom Digital Mod

The available predefined modulation types are ASK (amplitude shift keying), FSK (frequency shift keying), PSK (phase shift keying) and QAM (quadrature amplitude modulation). Additionally, a user defined modulation mapping can be applied (see "User Mapping" on page 259).

The actual modulation procedure is described by mapping, which assigns I and Q values (PSK and QAM) or frequency shifts (FSK) to every modulation symbol that occurs. This is represented graphically in the constellation diagrams.

The mapping for the selected modulation type is displayed in the "More..." submenu in the "Modulation" menu section (see "More - Modulation Type" on page 276).

The QAM procedures 16QAM, 32QAM, 64QAM have been produced in accordance with ETSI standard ETS 300429 for digital video broadcasting (DVB). The QAM procedures 256QAM and 1024QAM are not specified in this standard, but have been produced according to the same basic principles.

In the case of all FSK procedures, the user can set the symbol rate fSYMB up to a maximum value (see data sheet). If MSK is selected, the frequency deviation (FSK deviation) cannot be set since it is permanently set to ¼ of the symbol rate.

Table 5-5: Modulation type and associated mapping

<p><b>ASK</b></p> <p>1 bit per symbol</p> <p>SOUR:BB:DM:FORM ASK</p>  <p>The diagram is a 2D plot with 'I Value' on the horizontal axis and 'Q Value' on the vertical axis. Both axes range from -1 to 1 with major grid lines every 0.5 units. Two blue dots are plotted: one at (0, 0) labeled '0' and one at (1, 0) labeled '1'. The plot area has a light blue background.</p>	
<p><b>PSK</b></p>	

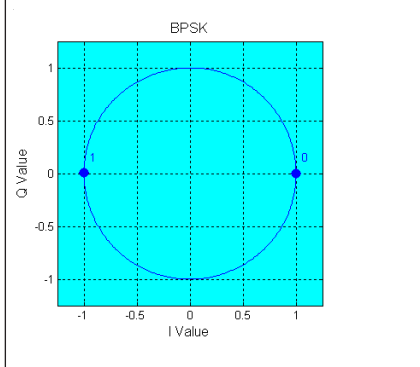
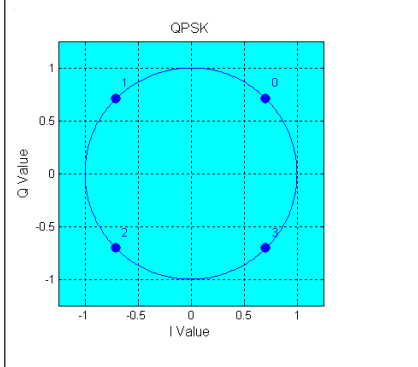
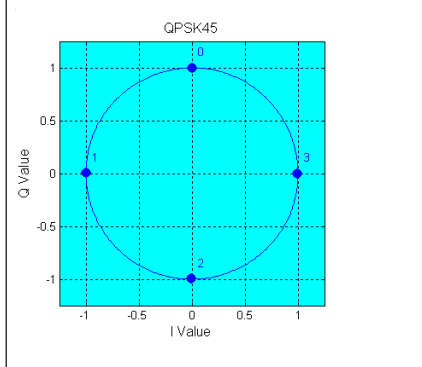
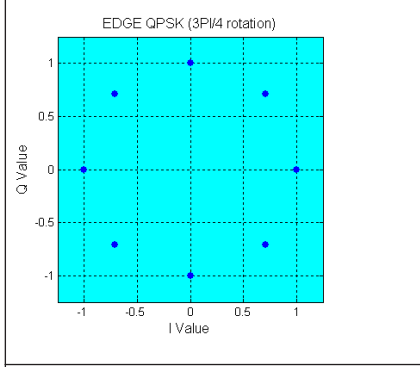
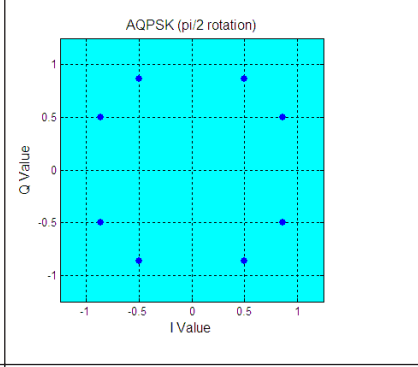
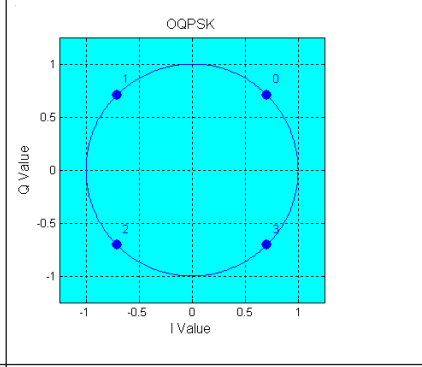
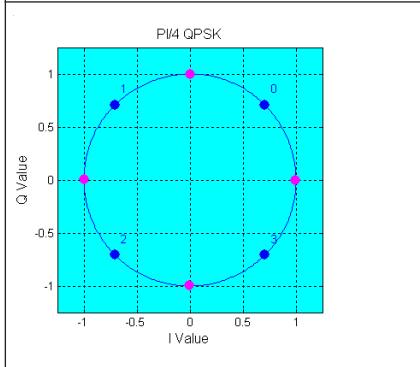
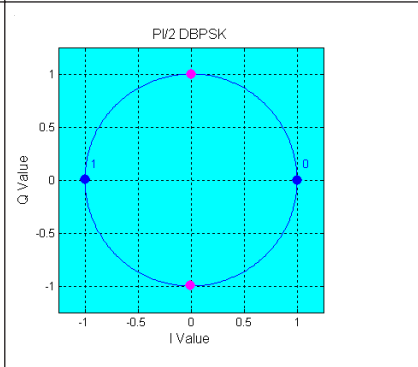
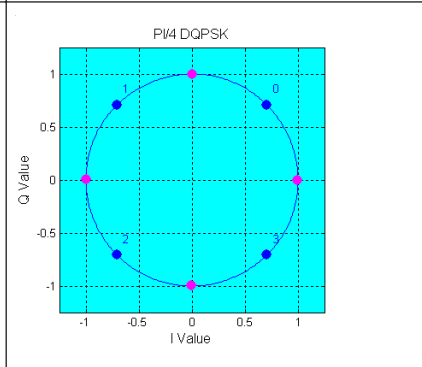
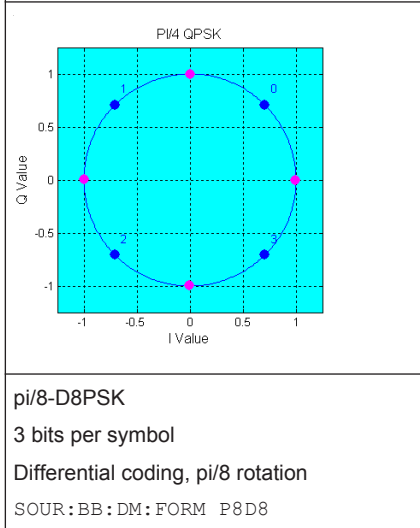
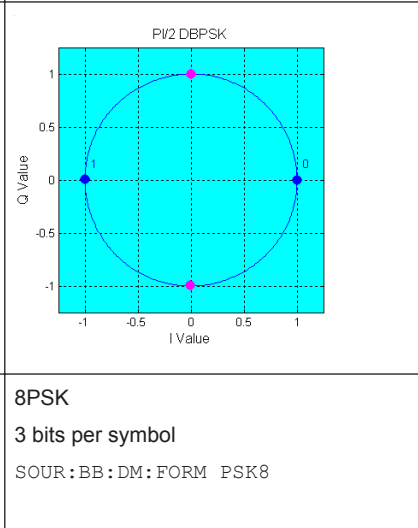
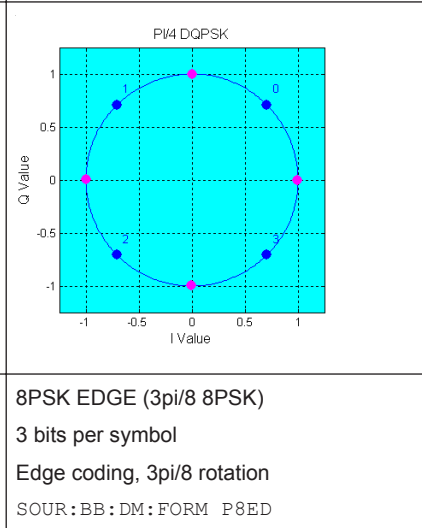

<p><b>BPSK</b> 1 bit per symbol SOUR:BB:DM:FORM BPSK</p> 	<p><b>QPSK</b> 2 bits per symbol SOUR:BB:DM:FORM QPSK</p> 	<p><b>QPSK 45° Offset</b> 2 bits per symbol, 45° rotation SOUR:BB:DM:FORM QPSK45</p> 
<p><b>QPSK EDGE</b> 2 bits per symbol, 3pi/4 rotation SOUR:BB:DM:FORM QEDGE</p> 	<p><b>AQPSK</b> 2 bits per symbol, pi/2 rotation SOUR:BB:DM:FORM AQPSK</p> 	<p><b>OQPSK</b> 2 bits per symbol, Q offset SOUR:BB:DM:FORM OQPSK</p> 
<p><b>pi/4-QPSK</b> 2 bits per symbol pi/4 rotation SOUR:BB:DM:FORM P4QP</p> 	<p><b>pi/2-DBPSK</b> 1 bit per symbol Differential coding, pi/2 rotation SOUR:BB:DM:FORM P2DB</p> 	<p><b>pi/4-DQPSK</b> 2 bits per symbol Differential coding, pi/4 rotation SOUR:BB:DM:FORM P4DQ</p> 
<p><b>pi/8-D8PSK</b> 3 bits per symbol Differential coding, pi/8 rotation SOUR:BB:DM:FORM P8D8</p> 	<p><b>8PSK</b> 3 bits per symbol SOUR:BB:DM:FORM PSK8</p> 	<p><b>8PSK EDGE (3pi/8 8PSK)</b> 3 bits per symbol Edge coding, 3pi/8 rotation SOUR:BB:DM:FORM P8ED</p> 

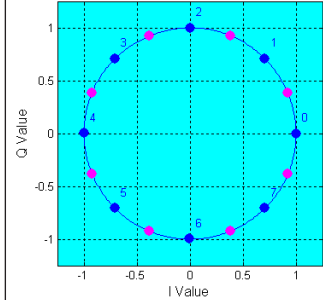
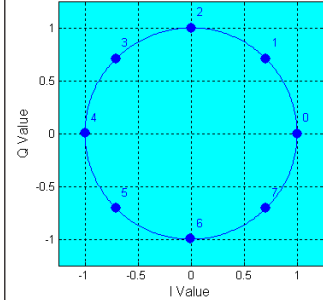
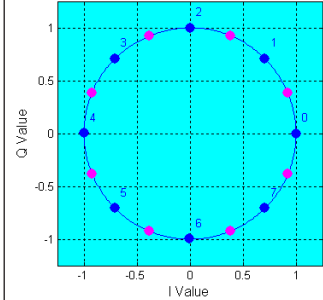
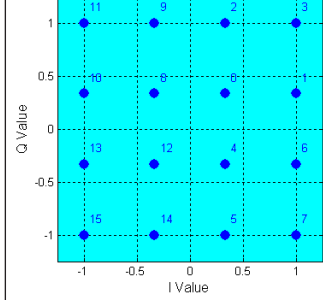
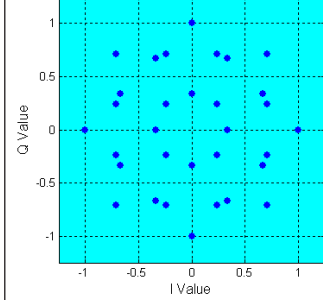
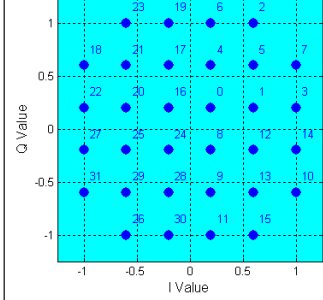
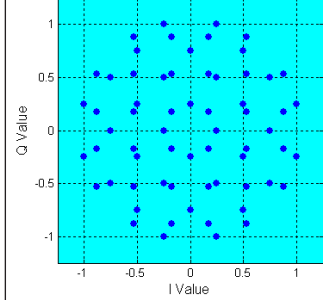
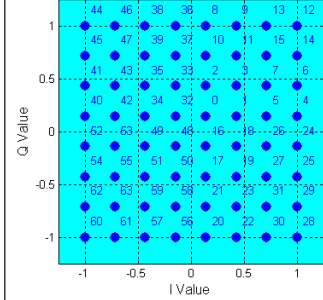
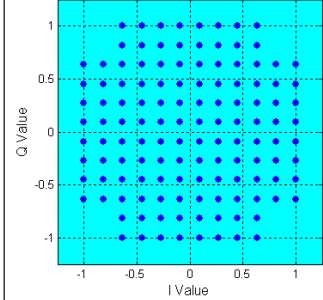
<p style="text-align: center;">Pi/8 D8PSK</p> 	<p style="text-align: center;">8PSK</p> 	<p style="text-align: center;">3Pi/8 8PSK</p> 
<p><b>QAM</b></p>		
<p><b>16QAM</b> 4 bits per symbol SOUR:BB:DM:FORM QAM16</p>	<p><b>16QAM EDGE</b> 4 bits per symbol, pi/4 rotation SOUR:BB:DM:FORM QAM16EDGE</p>	<p><b>32QAM</b> 5 bits per symbol SOUR:BB:DM:FORM QAM32</p>
<p style="text-align: center;">16QAM</p> 	<p style="text-align: center;">EDGE 16QAM (Pi/4 rotation)</p> 	<p style="text-align: center;">32QAM</p> 
<p><b>32QAM EDGE</b> 5 bits per symbol, -pi/4 rotation SOUR:BB:DM:FORM QAM32EDGE</p>	<p><b>64QAM</b> 6 bits per symbol SOUR:BB:DM:FORM QAM64</p>	<p><b>128QAM</b> 7 bits per symbol SOUR:BB:DM:FORM QAM128</p>
<p style="text-align: center;">EDGE 32QAM (-Pi/4 rotation)</p> 	<p style="text-align: center;">64QAM</p> 	<p style="text-align: center;">128QAM</p> 
<p><b>256QAM</b> 8 bits per symbol SOUR:BB:DM:FORM QAM256</p>	<p><b>1024QAM</b> 10 bits per symbol SOUR:BB:DM:FORM QAM1024</p>	<p><b>4096QAM</b> 12 bits per symbol SOUR:BB:DM:FORM QAM4096</p>

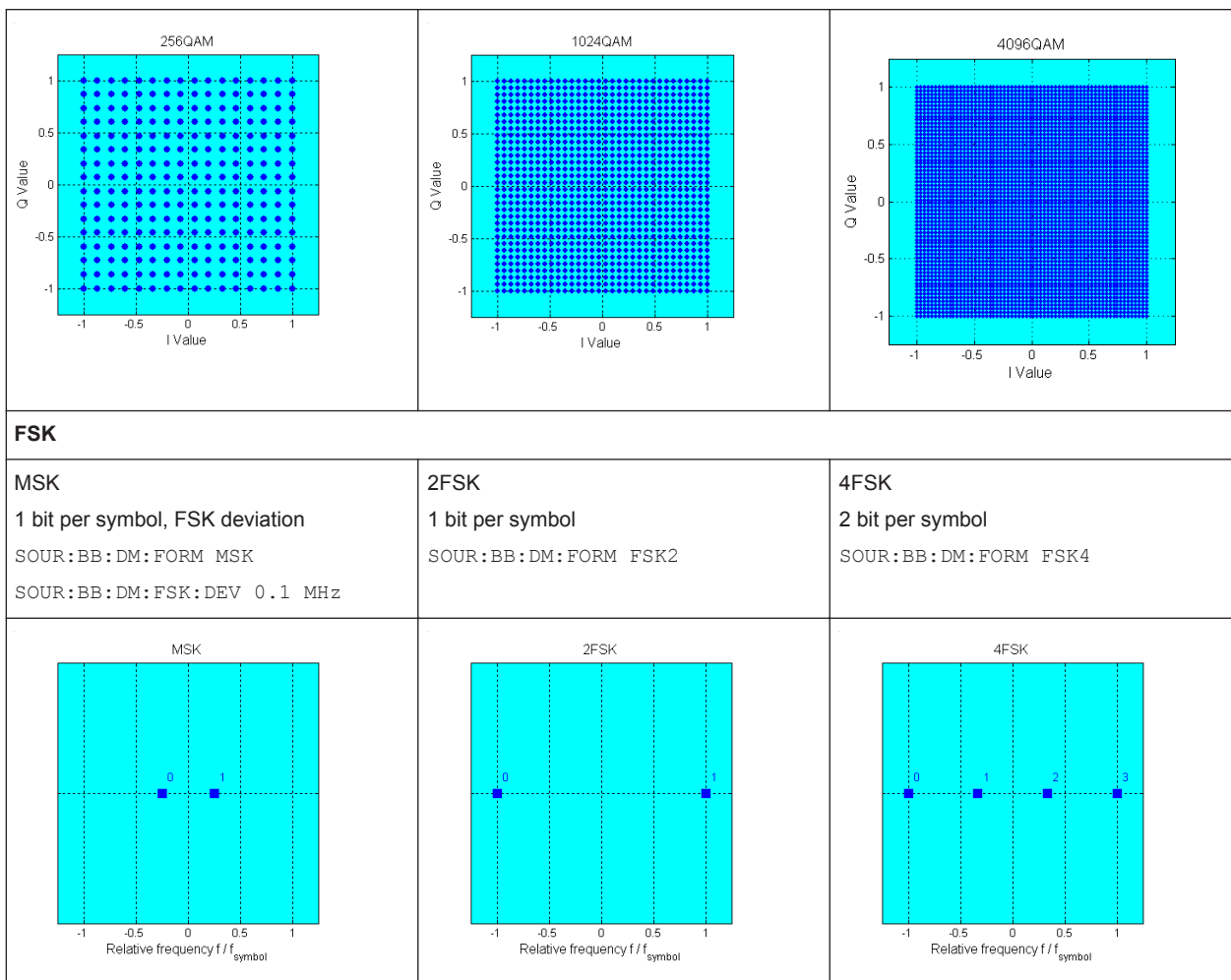

In addition to the FSK modulations, a variable FSK modulation with definable deviation per symbol is available.

[ :SOURce<hw> ] :BB:DM:FORMat on page 578

**User Mapping**

A user defined modulation mapping file can also be selected as modulation mapping source. The user modulation mapping file must have extension \*.vam and can be created with the R&S mapping wizard. The mapping wizard (mapwiz) is a tool from Rohde & Schwarz designed for editing modulation schemes (e.g. QPSK, 32QAM). Its main purpose is the assignment of logical symbol numbers to constellation points and the selection of modulation specific parameters. Beyond this it supports the creation of nearly any arbitrarily chosen constellation diagram. The output of mapwiz is a mapping file (\*.vam) that can be imported on a R&S AMU. The program was developed on a 32-bit Microsoft Windows platform under MATLAB. For more information, refer to the description "Introduction to "mapwiz" Mapping Editor" on the Rohde&Schwarz Internet page.

### 5.7.3.3 Coding - Custom Digital Mod

Modulation symbols are coded directly before I and Q values or frequency shifts are assigned. Coding is thus directly related to modulation methods, which is the reason why codings are not freely combinable with modulation methods. The following table shows which of the coding combinations are available and defines the modulation types for which the various coding procedures can be used.

In the notation used below  $a_n$  denotes the n-th input symbol and  $b_n$  denotes the correspondingly coded output symbol. Individual bits in the symbols from the LSB (least significant bit) to the MSB (most significant bit) are denoted by  $a_{0n}$ ,  $a_{1n}$  and so on. The same applies to the output symbols.

Table 5-6: Permissible coding combinations for modulation symbols and modulation type

	OFF	Differ- ential	Phase Diff.	Diff. +Gray	Gray	GSM	NADC, PDC, PHS, TETRA, APCO25 (PSK), PWT	TFTS/ TETRA	INMARSAT, ICO, WCDMA, cdma2000	VDL	APCO25 (FSK)	APCO25 (8PSK)
ASK	X	X		X	X							
BPSK	X	X		X	X							
$\pi/2$ DBPSK	X				X							
QPSK	X	X		X	X				X			
QPSK EDGE	X											
QPSK45° Off- set	X	X		X	X							
$\pi/4$ QPSK	X	X			X							
$\pi/4$ DQPSK	X				X		X	X				
8PSK	X	X		X	X					X		
AQPSK	X	X		X	X							
OQPSK	X	X		X	X							
8PSK_EDGE	X											
$\pi/8$ D8PSK	X				X							X
MSK	X	X		X	X	X						
2FSK	X	X		X	X	X						
4FSK	X	X		X	X						X	
8FSK	X	X		X	X							
16FSK	X	X		X	X							
16QAM	X	X	X	X	X							
16QAM EDGE	X											
32QAM	X	X	X	X	X							

	OFF	Differ- ential	Phase Diff.	Diff. +Gray	Gray	GSM	NADC, PDC, PHS, TETRA, APCO25 (PSK), PWT	TFTS/ TETRA	INMARSAT, ICO, WCDMA, cdma2000	VDL	APCO25 (FSK)	APCO25 (8PSK)
32QAM EDGE	X											
64QAM	X	X	X	X	X							
128QAM	X	X	X	X	X							
256QAM	X	X	X	X	X							
1024QAM	X	X	X	X	X							

### Modulation type pi/4DQPSK

With differential coding switched on at the same time, a constellation diagram is obtained for pi/4DQPSK which is similar to that obtained for 8PSK. Phase shifts are however assigned to the individual modulation symbols. The following tables show the assignment of modulation symbols to phase shifts of the I/Q vector in relation to the selected coding.

**Table 5-7: Phase shifts for pi/4DQPSK**

Modulation symbol $a_n$ (binary indication: MSB, LSB)	00	01	10	11
Phase shifts without coding	+ 45°	+ 135°	- 135°	- 45°
Phase shifts with coding NADC, PDC, PHS, TETRA or APCO25 (PSK)	+ 45°	+ 135°	- 45°	- 135°
Phase shifts with coding TFTS	- 135°	+ 135°	- 45°	+ 45°

### Coding algorithms

Common coding types are listed in the following table.

**Table 5-8: Coding algorithms**

Coding	Coding algorithm	Applicable for K bit/symbol
NONE	$b_n = a_n$	$k = 1...8$
Differential	$b_n = (a_n + b_{n-1}) \text{ modulo } 2^k$	$k = 1...7$
Differential + Gray	Gray coding with additional differ- ential coding	$k = 1...7$
GSM	$dc_n = \text{not}(d_n \text{ exor } d_{n-1})$	$k = 1$

**Example: Differential coding for QPSK modulation with K = 2 bit/symbol**

Decimal display; value range for modulation symbols

$$a_n \in \{0, 1, 2, 3\}$$

Recursive coding is defined as follows:  $b_n = (a_n + b_{n-1}) \text{ modulo } 4$

Depending on the state of a preceding modulation symbol  $b_{n-1}$  the coded modulation symbol  $b_n$  is obtained for example from modulation symbol  $a_n = 2$  as follows:

$a_n = 2$	$b_{n-1}$	$b_n$
	0	2
	1	3
	2	0
	3	1

By means of differential coding, the assignment between modulation symbols and phase differences shown in the following table is generated:

<b>Modulation symbol <math>a_n</math> (binary, MSB, LSB)</b>	00	01	10	11
<b>Phase difference</b>	0°	90°	180°	270°

**Example: Gray and differential coding for 8PSK modulation**

First, a gray coding is performed according to the gray code. Afterwards, a differential coding is performed according to the recursive coding algorithm quoted above. The assignment between modulation symbols and phase differences shown in the following table is generated:

"Differential coding according to VDL" can be used for modulation types with 3 bits/symbol, e.g. 8PSK.

*Table 5-9: Differential coding according to VDL*

<b>Modulation symbol <math>d_n</math></b>	000	001	010	011	100	101	110	111
<b>Phase difference</b>	0°	45°	135°	90°	270°	315°	225°	180°

"Phase differential coding" INMARSAT and PHASE DIFF correspond to system standards Inmarsat-M and DVB according to ETS 300 429. The INMARSAT coding can generally be used for modulation types with 2 bits/symbol, such as QPSK. It uses the following algorithm.

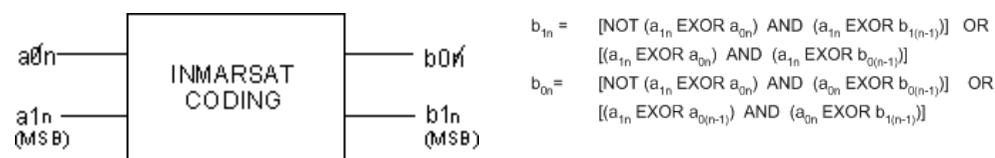

### 5.7.3.4 Baseband Filter - Custom Digital Mod

The R&S AMU offers a wide selection of predefined baseband filters. The filter characteristic for the selected filter is displayed in the "More..." submenu in the "Filter" menu section (see "Filter" on page 278). Additionally, a user defined filter can be selected (see "User filter" on page 267).

The following table shows the filters that are available, together with the associated parameters and remote control commands. The filter characteristic is displayed in graphical form.

Table 5-10: Baseband filter

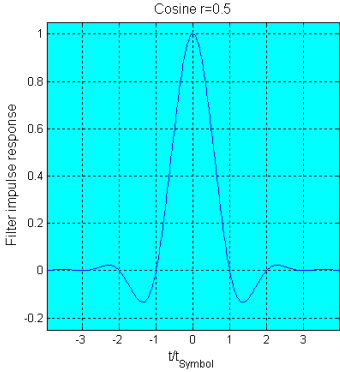
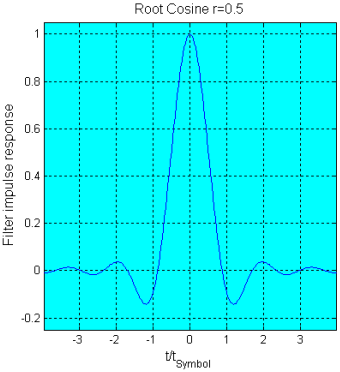
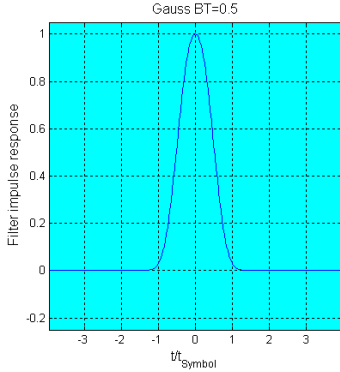
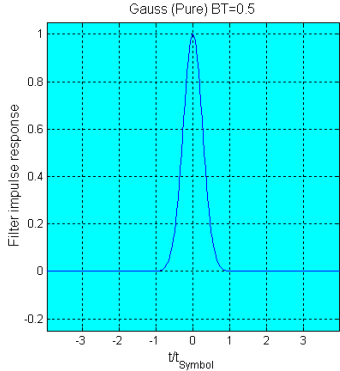
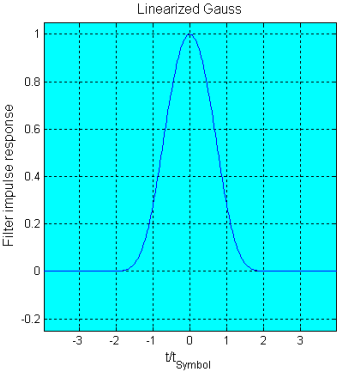
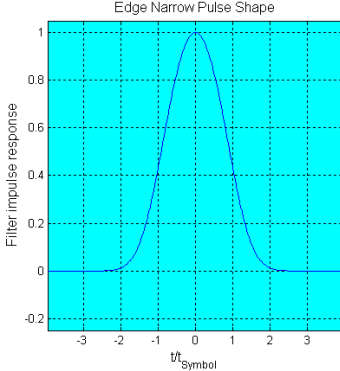
<p>Cosine Roll Off Factor <code>SOUR:BB:DM:FILT:TYPE COS</code> <code>SOUR:BB:DM:FILT:PAR:COS 0.99</code> Bandwidth <code>SOUR:BB:DM:FILT:PAR:COS:BAND 7200</code></p>	<p>Root Cosine Roll Off Factor <code>SOUR:BB:DM:FILT:TYPE RCOS</code> <code>SOUR:BB:DM:FILT:PAR:RCOS 0.99</code></p>	<p>Gauss (FSK) B x T <code>SOUR:BB:DM:FILT:TYPE GAUS</code> <code>SOUR:BB:DM:FILT:PAR:GAUS 2.5</code></p>
		
<p>Pure Gauss B x T <code>SOUR:BB:DM:FILT:TYPE PGA</code> <code>SOUR:BB:DM:FILT:PAR:PGA 2.5</code></p>	<p>Gauss Linearized <code>SOUR:BB:DM:FILT:TYPE LGA</code></p>	<p>Edge Narrow Pulse Shape <code>SOUR:BB:DM:FILT:TYPE ENPShape</code></p>
		
<p>Edge Wide Pulse Shape <code>SOUR:BB:DM:FILT:TYPE EWPSHape</code></p>	<p>cdmaOne <code>SOUR:BB:DM:FILT:TYPE CONE</code></p>	<p>cdmaOne 705 kHz <code>SOUR:BB:DM:FILT:TYPE COF705</code></p>

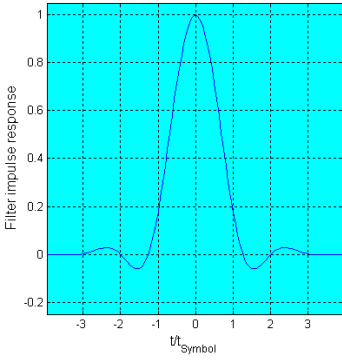
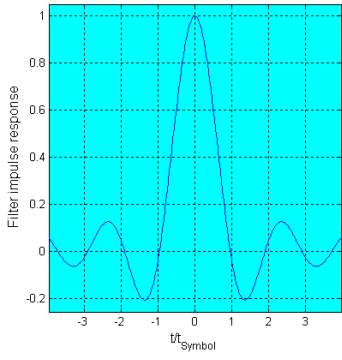
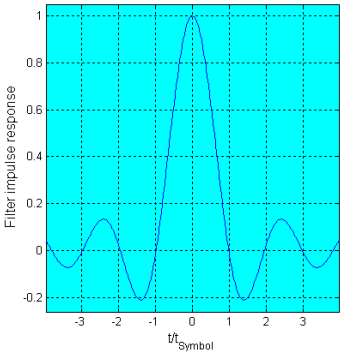
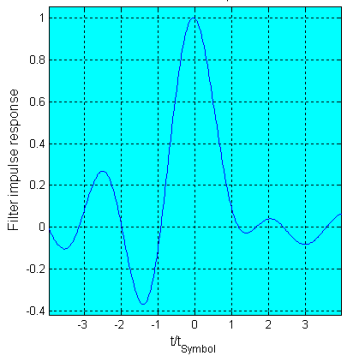
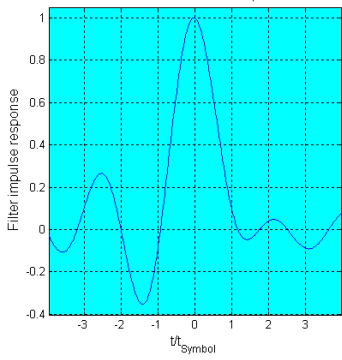
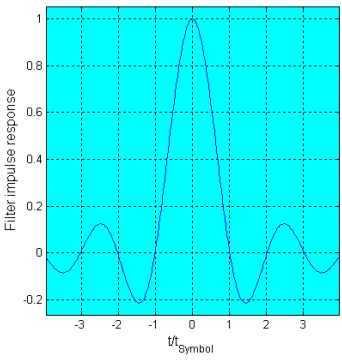
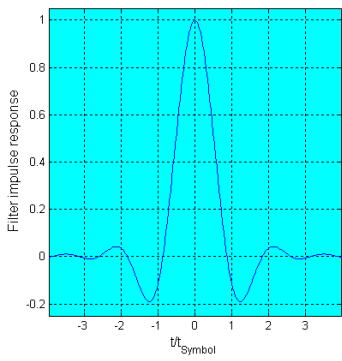
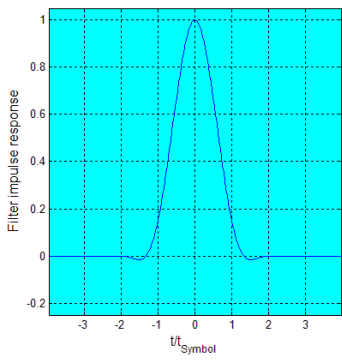
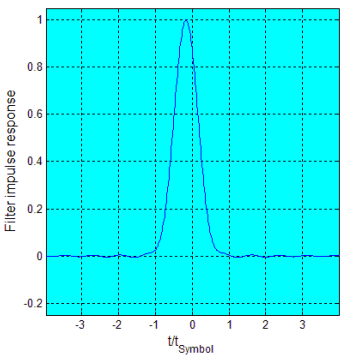
<p>Edge Wide Pulse Shape</p> 	<p>CdmaOne</p> 	<p>CdmaOne 705kHz</p> 
<p>cdmaOne + Equalizer SOUR:BB:DM:FILT:TYPE COE</p>	<p>cdmaOne 705 kHz + Equalizer SOUR:BB:DM:FILT:TYPE COFE228</p>	<p>cdma2000 3X SOUR:BB:DM:FILT:TYPE DM3x</p>
<p>CdmaOne with equalizer</p> 	<p>CdmaOne 705 kHz with equalizer</p> 	<p>Cdma2000 3X</p> 
<p>APCO25 Roll Off Factor SOUR:BB:DM:FILT:TYPE APCO25 SOUR:BB:DM:FILT:PAR:APC 0.5</p>	<p>APCO25 (H-CPM) SOUR:BB:DM:FILT:TYPE APCO25Hcpm</p>	<p>APCO25 (LSM) SOUR:BB:DM:FILT:TYPE APCO25Lsm Gauss Cut Off Frequency SOUR:BB:DM:FILT:PAR:APCO25L:GAU S 25000 Gauss Cut Off Frequency SOUR:BB:DM:FILT:PAR:APCO25:LOWP 75000</p>
<p>APCO25 r=0.5</p> 	<p>APCO H-CPM</p> 	<p>APCO LSM</p> 

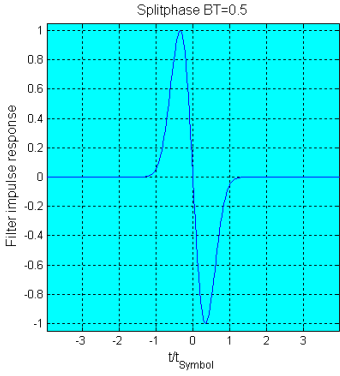
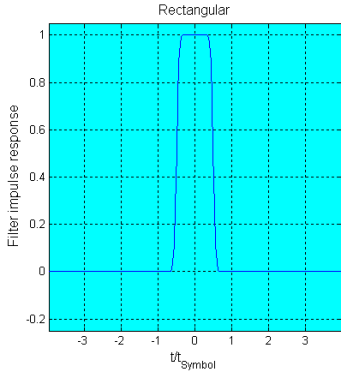
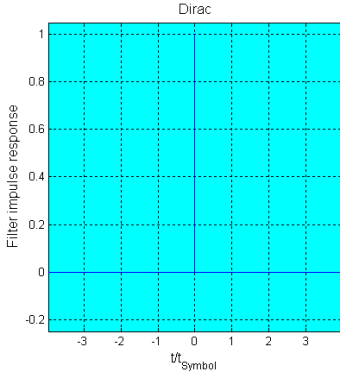
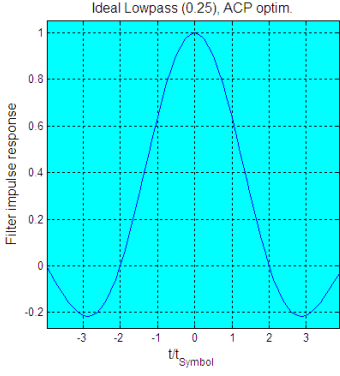
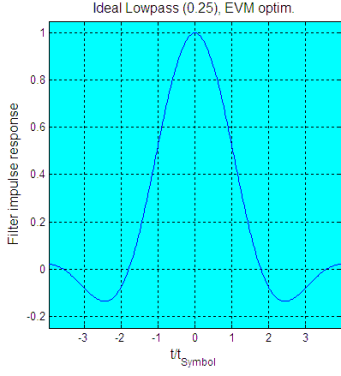
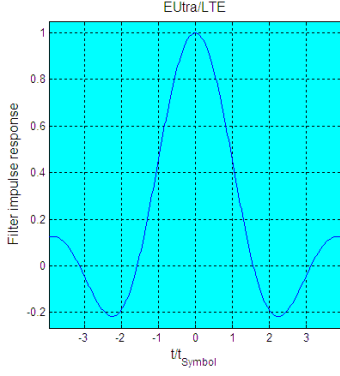

<p><b>Split Phase</b>  <b>BxT</b>  SOUR:BB:DM:FILT:TYPE SPH  SOUR:BB:DM:FILT:PAR:SPH 0.15</p>	<p><b>Rectangular</b>  SOUR:BB:DM:FILT:TYPE RECT</p>	<p><b>Dirac</b>  SOUR:BB:DM:FILT:TYPE DIRac</p>
		
<p><b>Lowpass ACP opt.</b>  SOUR:BB:DM:FILT:TYPE LPASs  SOUR:BB:DM:FILT:PAR:LAPS 0.5</p>	<p><b>Lowpass EVM opt.</b>  BB:DM:FILT:TYPE LPASSEVM  BB:DM:FILT:PAR:LAPSEVM 0.5</p>	<p><b>EUTRA/LTE</b>  SOUR:BB:DM:FILT:TYPE LTEFilter</p>
		

These predefined filters are designed for the special spectrum characteristics of the different communication standards. However, depending on the selected filter form one or more filter parameters are additionally provided for even precise adjustment of the filter characteristic, like more steeper edges or customization the transition bandwidth. For more information on the provided settings, refer to ["Impact of the Filter Parameters"](#) on page 265.

**Impact of the Filter Parameters**

The following is a simple description of the filter parameters and the way they affect the main filter characteristics. Changing filter parameters is an effective way to ensure that the entire bandwidth of the desired signal is allowed to pass and adjust the filter form to reach the spectrum mask requirements

### Cut Off Frequency

The cut-off frequency or corner frequency is a filter characteristic that defines the frequency at the 3 dB down point. This frequency is bound to the transition band; here the filter characteristic changes from the passband to the stopband, where the signal is suppressed.

### Rolloff Factor

The rolloff factor is a measure for the excess bandwidth compared to the ideal bandwidth of a "brick like" filter. The roll off factor affects the steepness of the filter flanks. A "Rolloff Factor" = 0 would result in the steepest theoretically possible flanks ; values near to 1 make the flanks more flat.

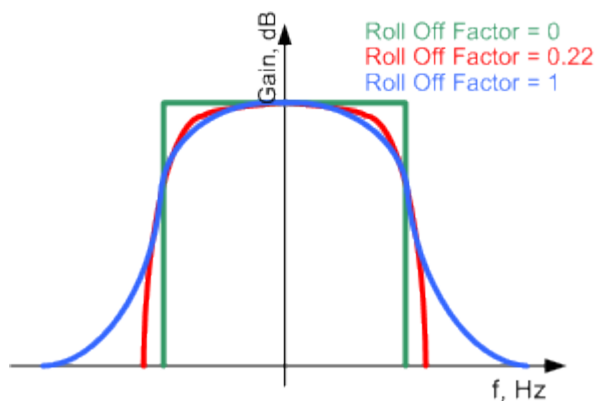

### Passband

The passband describes the frequency span that the filter passes unchanged. The total passband of a filter is given as follows:

$$\text{Bandwidth} = (1 + \text{"Roll Off Factor"}) * \text{"Symbol Rate"}$$

### Cut Off Frequency Shift

The "Cut Off Frequency Shift" affects the cut-off frequency in the way that the filter flanks are "moved" and the passband increases by "Cut Off Frequency Shift" \* "Sample Rate":

$$\text{Cut Off Frequency} = (1 + \text{"Cut Off Frequency Shift"}) * \text{"Sample Rate"}$$

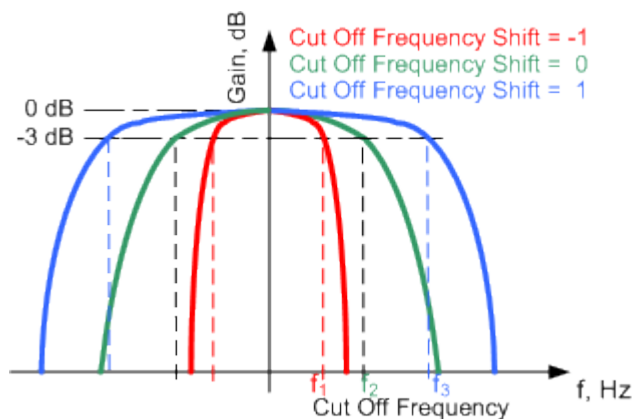

- A "Cut Off Frequency Shift" = -1 results in a very narrow-band filter
- Increasing the value up to 1 makes the filter more broad-band
- By "Cut Off Frequency Shift" = 0, the -3 dB point is at the frequency determined by the half of the selected "Sample Rate".

#### User filter

The user filter file must have extension `*.vaf` and can be created with the R&S filter wizard.

The filter wizard (filtwiz) is a tool from Rohde & Schwarz designed for creating filter files that can be imported on a R&S AMU. Its main purpose is the conversion of user-defined finite impulse response (FIR) filters into the filter format (`*.vaf`). Beyond this filtwiz provides designs for standard filters, e.g. Root Raised Cosine, Gaussian.

The program was developed on a 32-bit Microsoft Windows platform under MATLAB.

For more information, refer to the description "Introduction to "filtwiz" Filter Editor" on the Rohde&Schwarz Internet page.

#### 5.7.3.5 Conflicting Settings - Custom Digital Mod

Having selected a modulation procedure, not every combination is possible when selecting the settings for the modulation parameters "Symbol Rate" and "Coding". These restrictions inevitably give rise to conflicting settings if a parameter is changed and leads to a prohibited combination.

A conflicting setting is indicated by a message on the Info line in the display. The R&S AMU displays the setting entered by the user, but the modulation signal actually generated does not correspond to this display. A conflict of settings can be triggered if the user changes a parameter inappropriately. The message disappears as soon as a conflict-free setting is entered.

A list of the possible settings conflicts and messages in digital modulation can be found in [Chapter 9, "Status Information, Error Messages and Troubleshooting"](#), on page 675.

#### 5.7.3.6 Custom Digital Mod User Interface

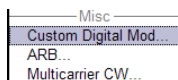

The menu for setting digital modulation can be opened either in the "Baseband" block or in the menu tree under "Baseband".

The "Custom Digital Modulation" menu enables direct selection of the data source, standard, symbol rate, coding, modulation type and filter. All other settings are entered in submenus which are called via "More" buttons.

The upper part of the menu is used for powering up digital modulation as well as for calling the default settings and user-defined standards.



The data source is selected and set in the "Data Source" section.

The "List Management" button opens a submenu for calling the data editor and the file manager.

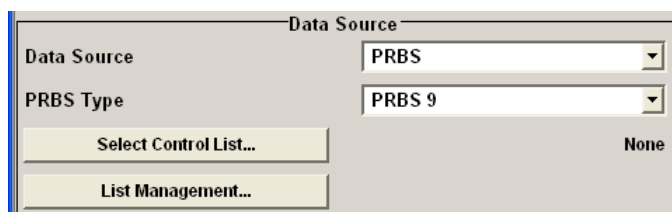

The middle part of the menu is used for selecting the standard, the symbol rate and the coding.

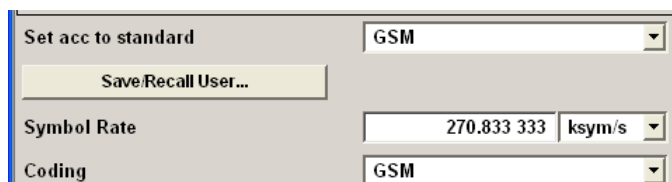

The modulation type is set in the "Modulation" section.

The "More" button opens a submenu that displays the mapping for the selected modulation.

This submenu can also be used to enable switching the signal between modulated and unmodulated.

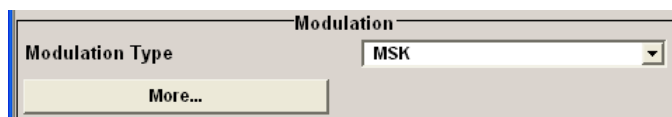

The filter is set in the "Filter" section. The "More" button opens a submenu where the filter characteristic of the selected filter is displayed.

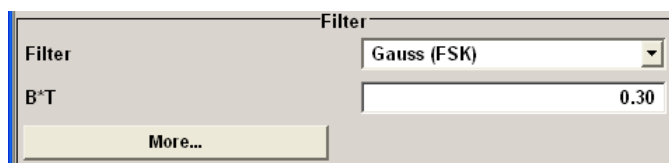

The buttons in the lower part of the menu open submenus for power ramping and for configuring triggers, markers and clocks.

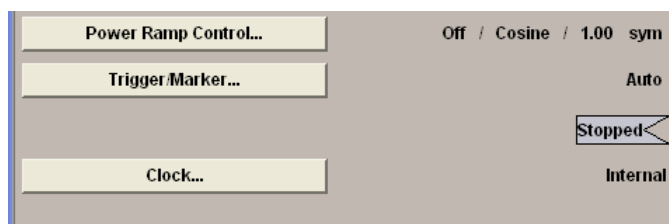

In each case the current setting is displayed next to the button.

### General Settings

The upper part of the menu is used for powering up digital modulation as well as for calling the default settings and user-defined standards.

#### State

Enables/disables digital modulation.

Switching on digital modulation turns off all the other digital standards.

In case of two-path instruments, this affects the same path.

The digital modulation is generated in realtime (no precalculated signal), and therefore all parameter changes (in the ON state) directly affect the output signal.

Remote command:

[ :SOURce<hw> ] :BB:DM:STATe on page 559

#### Set To Default

Calls default settings. The values are shown in the following table.

Parameter	Value
State	Not affected by Set to Default
Data Source	PRBS 9
Standard	GSM
Symbol Rate	270.833 ksymb/s
Coding	GSM
Modulation Type	MSK
Filter	Gauss (FSK)
Filter Parameter BxT	0.3
<b>Power Ramp Control</b>	

Parameter	Value
Attenuation	15 dB
Ramp Time	1 sym
Ramp Function	Cosine
Fall Delay	0
Rise Delay	0
Source	Internal
State	Off
<b>Trigger</b>	Mode Auto, Source Internal
<b>Clock</b>	
Source	Internal
Mode	Symbol

Remote command:

[ :SOURce<hw> ] :BB:DM:PRESet on page 557

### Save/Recall

Calls the "Save/Recall" dialog.

From the "Save/Recall" dialog the "File Select" windows for saving and recalling the complete settings in the "Custom Digital Modulation" menu can be called.

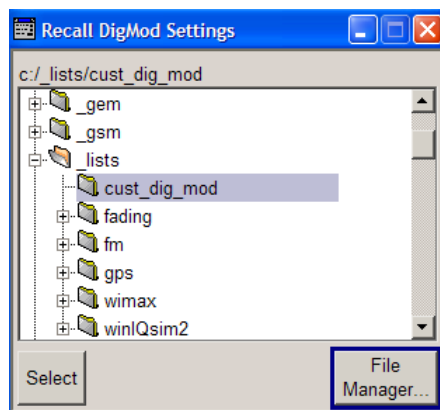

The "Digital Modulation" settings are stored as files with the predefined file extension \* .dm. The file name and the directory they are stored in are user-definable.

The complete settings in the "Custom Digital Modulation" dialog are saved and recalled.

Remote command:

[ :SOURce<hw> ] :BB:DM:SETTing:CATalog? on page 592

[ :SOURce<hw> ] :BB:DM:SETTing:DELeTe on page 593

[ :SOURce<hw> ] :BB:DM:SETTing:LOAD on page 593

[ :SOURce<hw> ] :BB:DM:SETTing:STORe on page 593

**Fast Save**

Determines whether the instrument performs an absolute or a differential storing of the settings.

Enable this function to accelerate the saving process by saving only the settings with values different to the default ones.

**Note:** This function is not affected by the "Preset" function.

Remote command:

`[ :SOURce<hw> ] :BB:DM:SETTing:STORe:FAST` on page 594

`[ :SOURce<hw> ] :BB:ARBitrary:MCARrier:SETTing:STORe:FAST` on page 538

refer to the description of firmware options for the syntax of the corresponding SCPI commands

**Data Source**

The data source is selected and set in the "Data Source" section. The parameters offered depend on the data source selected. The More button opens a submenu for calling the data editor and the file manager.

**Data Source**

Selects the data source (see [Chapter 5.7.2, "Data and Signal Sources in Baseband"](#), on page 242).

You may choose from the following data sources:

- "All 0, All 1"      0 data or 1 data is internally generated.
- "PRBS, PRBS Type"      PRBS data in accordance with the IUT-T with period lengths between  $2^9-1$  and  $2^{23}-1$  are internally generated. The length is selected in the "PRBS Type" input box.



Remote command:

`[ :SOURce<hw> ] :BB:DM:PRBS [ :LENGth ]` on page 557

- "Pattern"      A user-definable bit pattern with a maximum length of 64 bits is internally generated. The bit pattern is defined in the "Pattern" input box.

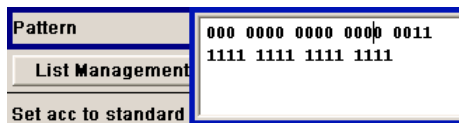

"Data List ...,  
Select Data" Data lists will be used.  
Data lists can be generated internally in the data editor or externally.  
Data lists are selected in the "File Select" window, which is called by means of the "Select Data" button.



The "File" "Manager" is used to transmit external data lists to the R&S AMU, and can be called within every "File" Select window by means of the "File" "Manager" button.

Remote command:

[ :SOURce<hw> ] :BB:DM:DLIST:SElect on page 590

"External Serial" External serial data is supplied via the DATA connector.

"External Parallel (AUX I/O)" External parallel data is supplied externally via the PARDATA pins on the AUX I/O interface.

Remote command:

[ :SOURce<hw> ] :BB:DM:SOURce on page 557

### List Management

Calls the menu for managing data and control lists (see "List Management" on page 280).

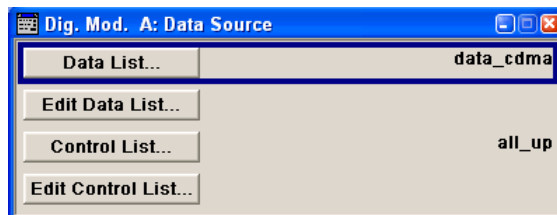

Remote command:

n.a.

### Standard, Symbol Rate, Coding

The middle part of the menu is used for selecting the standard, the symbol rate and the coding.

#### Set acc. to Standard

Selects a standard.

After selection, modulation parameters "Modulation Type", "Symbol Rate", "Filter" and "Coding" are automatically set in accordance with the standard.

If one of these parameters is subsequently altered, the display changes to User. The User setting can be saved to a file so that it can be recalled at some later time ("Save/Recall User.." button).

The following table shows the standards that are available, together with the associated settings of the modulation parameters.



Table 5-11: Standards (Custom Digital Modulation)

Standard	Modulation	Symbol Rate	Filter	Coding	Parameter for SCPI command
APCO Phase1 C4FM	4FSK, Deviation 1.8 KHz	4.8 ksym/s	APCO25, roll off = 0.2	APCO25(FSK)	APCOPH1C4fm
APCO Phase1 CQPSK	pi/4-DQPSK	4.8 ksym/s	Cosine, roll off = 0.2, BW = 4.8 KHz	APCO25(PSK)	APCOPH1CQpsk
APCO Phase2 H-CPM	4FSK, Deviation 3 KHz	6 ksym/s	APCO25 (H-CPM)	APCO25(FSK)	APCOPH2HCpm
APCO Phase2 H-DQPSK	pi/4-DQPSK	6 ksym/s	Cosine, roll off = 1, BW = 7.2 KHz	APCO25(PSK)	APCOPH2HDQpsk
APCO Phase2 H-D8PSK Wide	pi/8-D8PSK	4 ksym/s	Cosine, roll off = 1, BW = 7.2 KHz	APCO25(8PSK)	APCOPH2HD8PSKW
APCO Phase2 H-D8PSK Narrow	pi/8-D8PSK	4 ksym/s	Cosine, roll off = 1, BW = 5 KHz	APCO25(8PSK)	APCOPH2HD8PSKN
APCO Phase1 LSM	pi/4-DQPSK	4.8 ksym/s	APCO25 (LSM), Gauss Cut Off = 2.04 KHz, Low-pass Cut Off = 6.2 KHz	APCO25(8FSK)	APCOPH1Lsm
APCO Phase1 WCQPSK	pi/4-DQPSK	4.8 ksym/s	Cosine, roll off = 1, BW = 7.2 KHz	APCO25(8FSK)	APCOPH1Wcpsk
Bluetooth	2FSK, Deviation 160.0 kHz	1.0 Msym/s	Gauss, B*T = 0.5	OFF	BLUetooth
DECT	2FSK, Deviation 288.0 kHz	1.152 Msym/s	Gauss, B*T = 0.5	OFF	DECT
ETC (ARIB STD T55)	ASK, ASK Depth 100%	1.024 Msym/s	Split Phase, B*T = 2.0	OFF	ETC
GSM	MSK	270.833333 ksym/s	Gauss, B*T = 0.3	GSM	GSM
GSM EDGE	8PSK EDGE (3pi/8 8PSK)	270.833333 ksym/s	Gauss linear	OFF	GSMEdge
NADC	pi/4 DQPSK	24.3 ksym/s	Root Cosine, alpha = 0.35	NADC	NADC
PDC	pi/4 DQPSK	21.0 ksym/s	Root Cosine, alpha = 0.50	PDC	PDC
PHS	pi/4 DQPSK	192.0 ksym/s	Root Cosine, alpha = 0.50	PHS	PHS
TETRA	pi/4 DQPSK	18.0 ksym/s	Root Cosine, alpha = 0.35	TETRA	TETRa
WCDMA 3GPP	QPSK 45° Offset	3.84 Msym/s	Root Cosine, alpha = 0.22	WCDMA 3GPP	w3GPP
TD-SCDMA	QPSK 45° Offset	1.28 Msym/s	Root Cosine, alpha = 0.22	OFF	TCSCdma
cdma2000 Forward	QPSK	1.2288 Msym/s	cdmaOne + Equalizer	cdma2000	CFORward
cdma2000 Reverse	Offset QPSK	1.2288 Msym/s	cdmaOne	cdma2000	CREVerse

Standard	Modulation	Symbol Rate	Filter	Coding	Parameter for SCPI command
Worldspace	QPSK	1.84 Msym/s	Root Cosine, alpha = 0.40	OFF	WORLdspace
TFTS	pi/4 DQPSK	22.1 ksym/s	Root Cosine, alpha = 0.40	TFTS/ TETRA	TFTS

Remote command:

[\[:SOURce<hw>\]:BB:DM:STANdard](#) on page 559

### Save/Recall User

Calls the "Save/Recall User" menu.

From the "Save/Recall User Standard" menu the "File Select" windows for saving and recalling user-defined standards and the "File Manager" can be called.



User standards are stored as files with the predefined file extension \*.dm\_stu. The file name and the directory they are stored in are user-definable.

Remote command:

[\[:SOURce<hw>\]:BB:DM:STANdard:ULISt:CATalog?](#) on page 594

[\[:SOURce<hw>\]:BB:DM:STANdard:ULISt:DELeTe](#) on page 594

[\[:SOURce<hw>\]:BB:DM:STANdard:ULISt:LOAD](#) on page 595

[\[:SOURce<hw>\]:BB:DM:STANdard:ULISt:STORe](#) on page 595

### Symbol Rate

Selects the symbol rate.

The value range is dependent on the selected modulation type.

When the modulation type changes, the range is automatically redefined. If the set symbol rate is outside this range, an error message is generated and the maximum value for the newly chosen modulation type is automatically set.

Remote command:

[\[:SOURce<hw>\]:BB:DM:SRATe](#) on page 558

### Coding

Selects the coding (see [Chapter 5.7.3.3, "Coding - Custom Digital Mod"](#), on page 260).

The menu offers only the coding settings that are permissible for the chosen modulation type. The other coding methods are grayed out.

If the system is subsequently switched to a modulation type for which the selected coding is not available, coding is automatically set to OFF.

Remote command:

[\[:SOURce<hw>\]:BB:DM:CODing](#) on page 577

## Modulation

The modulation type is set in the "Modulation section". The parameters offered depend on what is currently selected. The "More..." button opens a submenu for displaying the user-defined mapping.

### Modulation Type

Selects a modulation type.

The associated symbol mapping is displayed in the "More..." submenu (see [Chapter 5.7.3.2, "Modulation Types - Custom Digital Mod"](#), on page 256).

If the "coding" that is set is not possible with the chosen modulation type, "coding" is set to "Off".

For selection "Variable FSK", the deviation of each symbol can be set in the "More..." submenu.

Remote command:

`[ :SOURce<hw> ] :BB:DM:FORMat` on page 578

### Load User Mapping

Selects user defined mapping table. This opens the "Select List File User Mapping" window in which the mapping table can be selected (see ["User Mapping"](#) on page 259). The button is only available if modulation type "USER" is selected.

The button "File Manager" calls the "File Manager" menu. The "File" "Manager" menu is used to display and delete files.

Remote command:

`[ :SOURce<hw> ] :BB:DM:MLISt:SElect` on page 592

`[ :SOURce<hw> ] :BB:DM:MLISt:CATalog?` on page 584

`[ :SOURce<hw> ] :BB:DM:MLISt:DElete` on page 591

### ASK Depth

Sets the modulation depth  $m$  for ASK modulation.

$$m = (\text{Amplitude}_{\max} - \text{Amplitude}_{\min}) / (\text{Amplitude}_{\max} + \text{Amplitude}_{\min})$$

Remote command:

`[ :SOURce<hw> ] :BB:DM:ASK:DEPTH` on page 577

### FSK Deviation

Sets the frequency deviation for FSK modulation. The range of values depends on the chosen symbol rate (see data sheet).

Whenever "MSK" is selected, the deviation corresponds to 1/4 of the symbol rate and cannot be set.

Remote command:

`[ :SOURce<hw> ] :BB:DM:FSK:DEVIation` on page 578

### Angle Alpha

For AQPSK modulation, sets the angle alpha between the point (0,0) and the I axis.

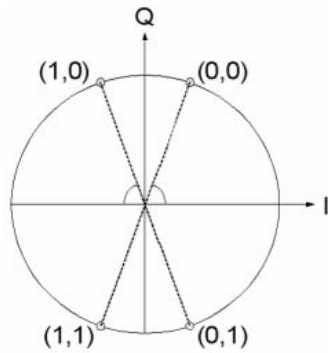

Remote command:

`[ :SOURce<hw> ] :BB:DM:AQPSk:ANGLE` on page 577

**More - Modulation Type**

Calls the submenu which displays the mapping of the currently selected modulation type and the digital modulation delay in the case of an external data source.

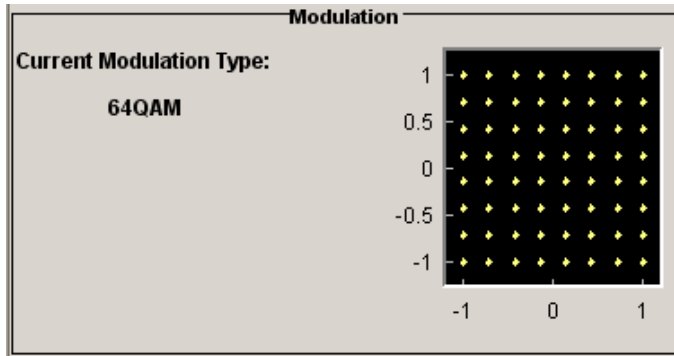

The "Modulation - CW Switching" section can be used to enable switching of the signal between modulated and unmodulated.

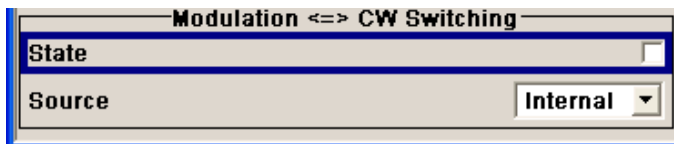

In case of selection "Variable FSK", the FSK type and the deviation for each symbols is set in the "Variable FSK" section.

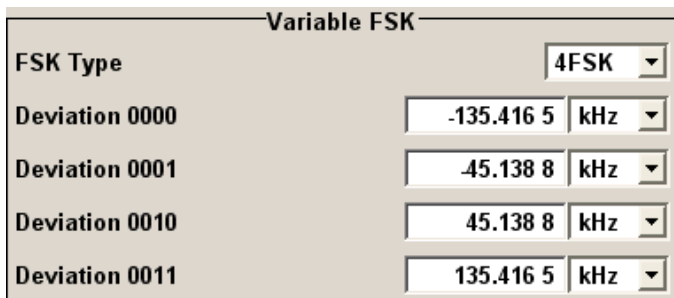

**FSK Type**

(Variable FSK only)

Selects the FSK modulation type for selection "Variable FSK".

You may choose from 4FSK, 8FSK and 16FSK.

Remote command:

[\[:SOURce<hw>\]:BB:DM:FSK:VARiable:TYPE](#) on page 579

**Deviation xxxx**

(Variable FSK only)

Set the deviation of the associated symbol. The number of symbols depends on the selected modulation type. The value of each symbol is indicated in binary format.

Remote command:

[\[:SOURce<hw>\]:BB:DM:FSK:VARiable:SYMBOL<ch0>:DEVIation](#) on page 579

**Modulation Delay**

(Data Source ext serial and ext parallel only)

Displays the digital modulation delay from the data input to the I/Q output.

The value is displayed only if an external synchronous data source is selected. In this case the value represents the delay between the active clock edge for data and the corresponding peak I/Q value (associated with this data item) on the I/Q connectors.

Remote command:

[\[:SOURce<hw>\]:BB:DM:MDELay?](#) on page 580

**Current Modulation Type**

Displays the currently selected modulation type together with its associated mapping.

Remote command:

n.a.

**Modulation - CW Switching**

The "Modulation <=> CW Switching" section is used to enable switching the signal between modulated and unmodulated.

**State Mod - CW**

Enables switching between a modulated and an unmodulated signal.

Switching is carried out by a control signal (CW) that is defined internally in the control list or supplied from an external source via a user-defined input.

Remote command:

[\[:SOURce<hw>\]:BB:DM:SWITching:STATE](#) on page 560

**Source Mod - CW**

Selects the CW control signal for switching between a modulated and an unmodulated signal.

"Internal"      The CW signal in the control list is used for the control.  
The internal signal can be output on one of the user interfaces.

"External" The control signal on the CW pin of the AUX I/O connector is used. For two path instruments, path A and B.

Remote command:

[\[:SOURce<hw>\]:BB:DM:SWITChing:SOURce](#) on page 559

### Filter

The filter is set in the Filter section.

### Filter

Selects the baseband filter (see [Chapter 5.7.3.4, "Baseband Filter - Custom Digital Mod"](#), on page 263).

Remote command:

[\[:SOURce<hw>\]:BB:DM:FILTer:TYPE](#) on page 576

### Filter Parameter

Sets the filter parameter.

The filter parameter offered ("Roll Off Factor" or "B x T") depends on the currently selected filter type.

Remote command:

[\[:SOURce<hw>\]:BB:DM:FILTer:PARAmeter:APCO25](#) on page 574

[\[:SOURce<hw>\]:BB:DM:FILTer:PARAmeter:COSine\[:ROLLoff\]](#) on page 574

[\[:SOURce<hw>\]:BB:DM:FILTer:PARAmeter:GAUSSs](#) on page 574

[\[:SOURce<hw>\]:BB:DM:FILTer:PARAmeter:PGAuss](#) on page 574

[\[:SOURce<hw>\]:BB:DM:FILTer:PARAmeter:RCOSine](#) on page 574

[\[:SOURce<hw>\]:BB:DM:FILTer:PARAmeter:SPHase](#) on page 574

### Cut Off Frequency Factor

(available for filter parameter Lowpass and APCO25 (LSM) only)

Sets the value for the cut off frequency factor. The cut off frequency of the filter can be adjusted to reach spectrum mask requirements.

Remote command:

[\[:SOURce<hw>\]:BB:DM:FILTer:PARAmeter:LPASs](#) on page 574

[\[:SOURce<hw>\]:BB:DM:FILTer:PARAmeter:LPASSEVM](#) on page 574

[\[:SOURce<hw>\]:BB:DM:FILTer:PARAmeter:APCO25Lsm:GAUSSs](#) on page 576

[\[:SOURce<hw>\]:BB:DM:FILTer:PARAmeter:APCO25Lsm:LOWPass](#) on page 576

### Bandwidth

Determines the bandwidth of the cosine filter, so that the function  $H(f) = 0$  is fulfilled for  $f \geq (1+RollOff)*Bandwidth/2$ .

Remote command:

[\[:SOURce<hw>\]:BB:DM:FILTer:PARAmeter:COSine:BANDwidth](#) on page 575

### Oversampling

Determines the upsampling factor. If the check box is activated, the most sensible parameter values are selected. The value depends on the coherence check. If the check box is deactivated, the values can be changed manually.

Remote command:

[ :SOURce<hw> ] :BB:DM:FILTer:OSAMpling:AUTO on page 574

[ :SOURce<hw> ] :BB:DM:FILTer:OSAMpling on page 574

### More - Filter

Calls the menu for displaying the filter characteristic of the currently selected filter.

### Load User Filter

Calls the menu "Select List File User Filter" for selecting a user-defined filter file with extension \*.vaf (see "User filter" on page 267). The button is only available if filter type "USER" is selected.

The button "File" "Manager" calls the "File" "Manager" menu. The "File" "Manager" menu is used to display and delete files.

Remote command:

[ :SOURce<hw> ] :BB:DM:FLISt:SElect on page 591

[ :SOURce<hw> ] :BB:DM:FLISt:CATalog? on page 584

[ :SOURce<hw> ] :BB:DM:FLISt:DElete on page 590

### Current Filter Response

Displays the filter characteristic of the currently selected filter.

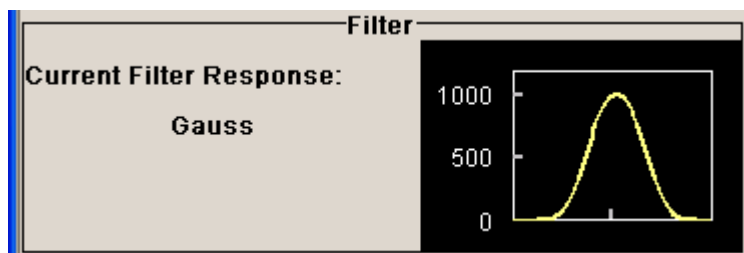

Remote command:

n.a.

### Power Ramp

The lower part of the "Custom Digital Modulation" menu is used for setting triggers, marker and clocks, as well as for power ramp settings.

### Power Ramp Control

Calls the power ramp control menu (see "Power Ramp Control" on page 287).

Remote command:

n.a.

### Trigger/Marker

Calls the "Trigger/Marker/Clock" dialog, used to select the trigger source, set the time delay on an external trigger signal and configure the marker output signals.

See "Trigger/Marker/Clock" on page 289.

Remote command:

n.a.

**Execute Trigger**

Executes trigger manually. A manual trigger can be executed only when an internal trigger source and a trigger mode other than Auto have been selected.

Remote command:

[ :SOURce<hw> ] :BB:DM:TRIGger:EXECute on page 563

**Clock**

Calls the "Trigger/Marker/Clock" menu. The "Trigger/Marker/Clock" menu is used to select the clock source (see "Clock Settings" on page 295).

Remote command:

n.a.

**List Management**

The "List Management" menu is called from the "Custom Digital Modulation" main menu.

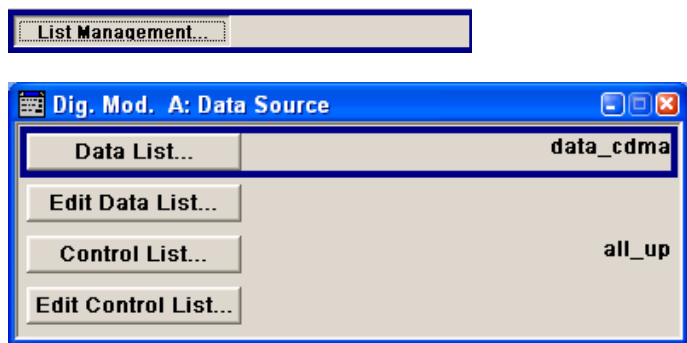

The data and control lists are selected and created in the "File Select" menu which is called up by means of the "Data List..." and "Control List..." buttons.



The "File Manager" is used to copy, rename and delete files and to create directories.

For more information, see [Chapter 4.7, "File Management"](#), on page 123.

To ensure that the selected data or control list is used for generating the digital signal, the list must be selected as the data source:

Data	Parameter	Selection
Digital data	"Source"	DList
Marker	"Marker Mode"	CList
Control signals CW, Level Attenuation and Burst Gate	"Source"	Internal



The data editor is called using the "Edit Data List..." and "Edit Control List ..." buttons. The contents of the selected list are displayed.

Operating the list editors is described in [Chapter 4.5.1, "Working with Data Editor"](#), on page 116.

#### Select Data/Control List

Selects data/control list. This opens the "File Select" window in which the data/control list can be selected.

Remote command:

[ :SOURce<hw> ] :BB:DM:DLISt:SElect on page 590

[ :SOURce<hw> ] :BB:DM:CLISt:SElect on page 587

#### Create Data/Control List

Creates new data/control list. This opens the "File Select" window in which the data/control list can be created.

The file name has to be entered in field "File Name:". The new list contains no data, it can be edited in the list editor.

Remote command:

[ :SOURce<hw> ] :BB:DM:DLISt:SElect on page 590

[ :SOURce<hw> ] :BB:DM:CLISt:SElect on page 587

#### File Manager

Calls the "File Manager".

The "File Manager" is used to copy, delete and rename files and to create new directories.

For detailed description, see [Chapter 4.7.2, "File Manager"](#), on page 126.

Remote command:

[ :SOURce<hw> ] :BB:DM:DLISt:SElect on page 590

[ :SOURce<hw> ] :BB:DM:DLISt:COpy on page 585

[ :SOURce<hw> ] :BB:DM:DLISt:DElete on page 589

[ :SOURce<hw> ] :BB:DM:CLISt:SElect on page 587

[ :SOURce<hw> ] :BB:DM:CLISt:COpy on page 585

[ :SOURce<hw> ] :BB:DM:CLISt:DElete on page 587

#### Data List Editor

The "Data List Editor" for editing the selected data list is called up in the "List Management" submenu of the "Custom Digital Modulation" main menu by means of the "Edit Data List..." button.

See [Chapter 4.5, "Editors"](#), on page 115 for description on how to use the editor.

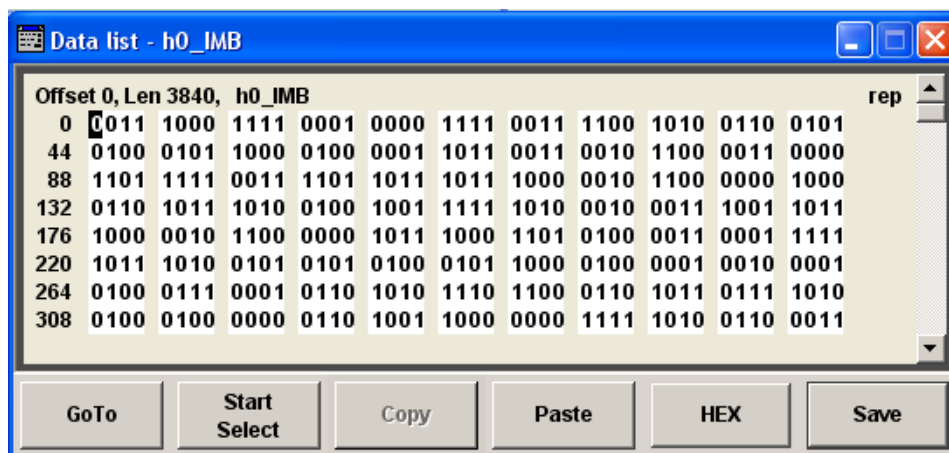

### Data List Editor

A list of binary values with a maximum length of  $2^{31}$  bits can be entered in the "Data List Editor". This value corresponds to a file size of approx. 268 Mbyte.

To increase readability, the bits are displayed in groups of four. The current cursor position, the length of the list and the list file name are displayed above the list. The offset starts with the value 0 which corresponds to the bit position on the left side of the first row, i.e. the beginning of the list. On the left edge of the editor, the last three offset positions are specified at the beginning of the row.

An existing list can be edited in the insert or overwrite mode.

Remote command:

[\[:SOURce<hw>\]:BB:DM:DLIST:SElect](#) on page 590

[\[:SOURce<hw>\]:BB:DM:DLIST:DATA](#) on page 588

[\[:SOURce<hw>\]:BB:DM:DLIST:DATA:APPend](#) on page 589

### GoTo ← Data List Editor

Opens the entry window for the bit position. The cursor marks the bit at the selected position.

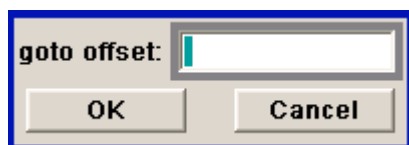

Remote command:

n.a.

### Start Select ← Data List Editor

Defines the current cursor position as the start position for the range to be marked. The stop position is defined by entering an offset under "GoTo".

When a start position has been activated, the button will be re-labelled to "Undo Select". When the button is clicked now, the selected range will be deactivated.

Remote command:

n.a.

**Copy ← Data List Editor**

Copies the selected values.

Remote command:

n.a.

**Cut ← Data List Editor**

Cuts the selected values.

Remote command:

n.a.

**Paste ← Data List Editor**

Pastes the values that have been copied or cut before.

Remote command:

n.a.

**Hex ← Data List Editor**

Switchover to hexadecimal display.

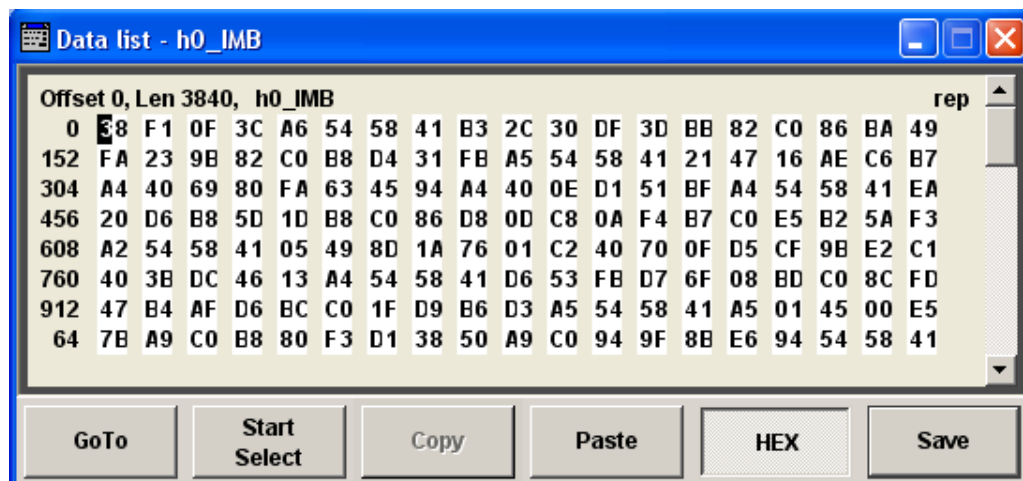

Each four bits are displayed as a hexadecimal value: To increase readability, the hexadecimal values in turn are displayed in pairs of two. The hex functions are automatically assigned to the numeric keys at the front panel.

Remote command:

n.a.

**Save (Data List) ← Data List Editor**

Saves the changes made to the Data List file selected for editing.

Remote command:

n.a.

**Control and Marker List Editor**

The "Control and Marker List Editor" for editing the selected control list is called up in the "List Management" submenu of the "Custom Digital Modulation" main menu by means of the "Edit Control List"... button.

### Edit Control List

The available marker signals and the CW, Hop, Burst Gate and Level Attenuation control signals can be defined in the "Control and Marker List Editor".



The marker signals defined in the Control and Marker List Editor are activated by selecting the Marker mode "CList" in the "Trigger/Marker/Clock" menu. The control signals have to be activated by selecting an "Internal Source" in the respective setting menu, e.g. the "Power Ramp Control" menu for the Burst Gate and Level Attenuation control signals.

The available marker/control signals are color-coded. In the left "Configure Control Signal" section, each individual signal is assigned a colour; a check in the check box shows the marker for which the "CList" marker type has been selected and the control signal for which the "Internal" source has been selected.

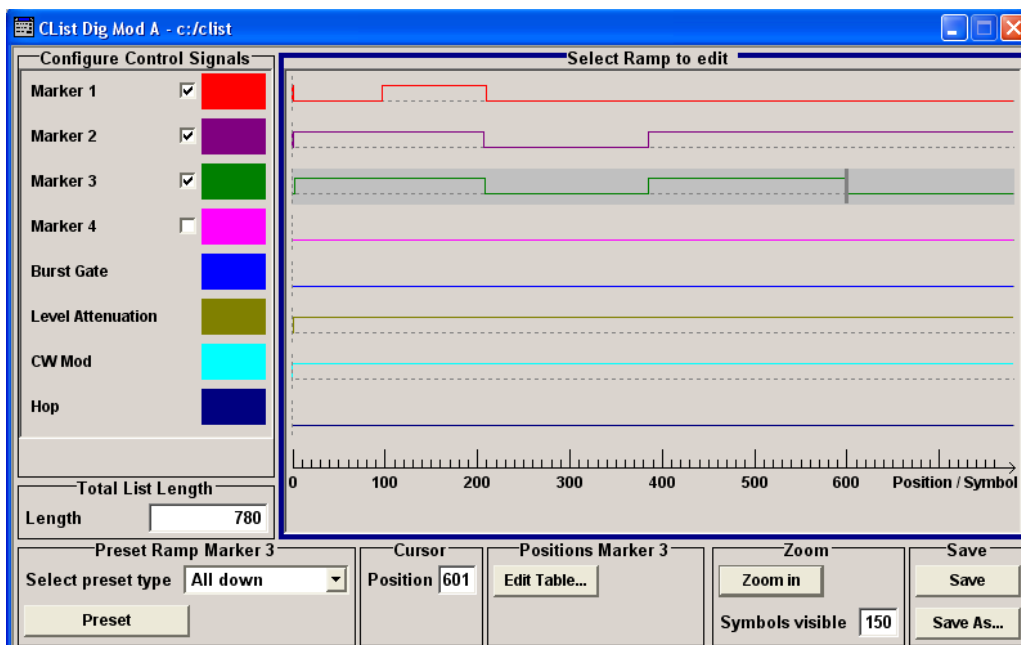

In the "Select Ramp to Edit" section the signal characteristics are graphically displayed. The scaling of the x-axis is always adapted to the overall length of the control list to provide constant overview of all defined ramps.

The ramps can be assigned the exact bit position in the signal by means of

- The bit scale below the marker/control signal characteristic.
- The display of the current cursor position in the "Cursor" menu section if the cursor marks the ramp.

The ramps can be set either graphically in the "Select Ramp to Edit" section or in the table of the "Positions <Signal>" section in the lower right corner. To make the setting easy, a selection of preset ramp characteristics is offered in the "Preset Ramp <Signal>" section.

### Edit Control List

The configuration of the currently selected control list is displayed. This list is either selected in the "File Select" menu ("List Management" submenu by means of the "Control List..." button) or via the remote-control command.

Remote command:

[ :SOURce<hw> ] :BB:DM:CLIST:SElect on page 587

[ :SOURce<hw> ] :BB:DM:CLIST:DATA on page 586

### Configure Control Signal

Displays the colour the marker/control signal has been assigned.

Displays whether the "CList" marker type has been selected in the Trigger/Marker/Clock menu for this marker.

Displays whether the "Internal" source has been selected for this control signal in the individual setting menu.

Burst Gate and Level Attenuation are set in the "Power Ramping" submenu, CW in the "Modulation" submenu.

The source "CList/Internal" for the individual marker/control signal can be selected here as well and will then be used in the associated menus.

Remote command:

n.a.

### Select Ramp to Edit

Graphically edit marker/control signals.

For this purpose, the cursor is set to the position where a ramp is required. The ramp is generated by pressing Enter (e.g. clicking on the rotary knob). Any number of ramps can be defined per marker. Each of the generated ramp positions will be saved even if the definition of another ramp produces a low/low or high/high transition. These ramps are displayed as dashed lines.

Existing ramps can be shifted after the cursor has been placed on the ramp and Enter has been pressed - it then changes colour twice. The ramp is shifted by using the cursor keys or the rotary knob. The new position is determined by pressing Enter again.

Ramps can be deleted by means of the BACKSPACE key after the cursor has been placed on the ramp.

For detailed information on how to operate the control and marker list editor, see [Chapter 4.5.2, "Working with Control and Marker List Editor"](#), on page 117.

Remote command:

n.a.

### Total List Length

Enters the length of the definition range of the control list in bits. The starting value is always bit 0. The entire definition range is displayed, i.e. the bit scale is adapted to the entry.

With very long control lists, the displayed area can be zoomed around the current cursor position ("Zoom in" button).

The preset functions set the ramp in the center of the currently selected area.

If the definition range is decreased, the ramps outside the range are lost.

When used, the control list is always repeated over the length of the definition range if the length of the data list exceeds the length of the control list.

Remote command:

n.a.

### Preset Type

Activates presetting for the ramp characteristic of the selected control signal. The pre-setting is selected with "Preset Type" and activated by means of the "Preset" button.

You can select from:

"All Up "	The marker/control signal is continuously high.
"All Down"	The marker/control signal is continuously low.
"Ramp Up"	The marker/control signal contains a ramp from low to high. The ramp is shifted to the center of the displayed signal area and can subsequently be shifted as required.
"Ramp Down"	The marker/control signal contains a ramp from high to low. The ramp is shifted to the center of the displayed signal area and can subsequently be shifted as required.
"Ramp Up/ Down"	The marker/control signal contains a ramp from low to high and from high to low. The ramps are symmetrically shifted around the center of the displayed signal area and can subsequently be shifted as required.
"Ramp Down/Up"	The marker/control signal contains a ramp from high to low and from low to high. The ramps are symmetrically shifted around the center of the displayed signal area and can subsequently be shifted as required.

Remote command:

n.a.

### Cursor Position

Enters the cursor position.

In the graphic display, the cursor is positioned according to the entry.

Vice versa, graphically shifting the cursor will change the displayed value.

If the entered value exceeds the selected length of the definition range, the length is adjusted automatically.

Remote command:

n.a.

### Positions Control Signal

Opens table by using the "Edit Table .." button.

The ramps of the selected signal can be edited in the table. When the table is opened, the current configuration of the selected marker/control signal is displayed.

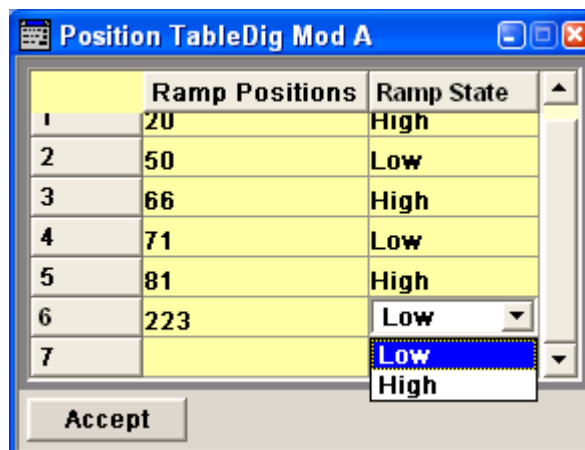

The bit position is specified in the "Ramp Position" column, the high or low signal status in the "Ramp State" column. At the end of the list, there is always a blank row for entering new values.

The changes are accepted in the graphic display after pressing the "Accept" button.

Remote command:

n.a.

#### Zoom/Visible

Zooms the displayed area of the control list. The designation of the button changes from "Zoom in" to "Zoom out".

With long control lists, the displayed area can be zoomed around the current "Cursor Position".

Parameter "Visible/Bits Visible" determines the number of symbols/bits to be displayed.

Ramps outside the displayed area are not lost by zooming.

Remote command:

n.a.

#### Save/Save As

Pressing the "Save" button saves the changes made to the CList file selected for editing.

Selecting the "Save As" button creates a new control list. This opens the "Create Lists Files Which Name?" window in which the control list can be created.

The file name has to be entered in field "File Name."

Remote command:

n.a.

#### Power Ramp Control

The Power Ramp Control menu is accessed via the "Custom Digital Modulation" main menu.

The dialog provides access to the settings used to configure the power ramping, like the source for the necessary control signals "Burst" and "Lev\_Att", the form of the ramp

function and the applied attenuation (see also "[Power Ramping and Level Attenuation](#)" on page 250).



Power ramping is possible up to a symbol rate of 5 MHz. If a higher symbol rate is set, power ramping is automatically switched off and an error message is output.

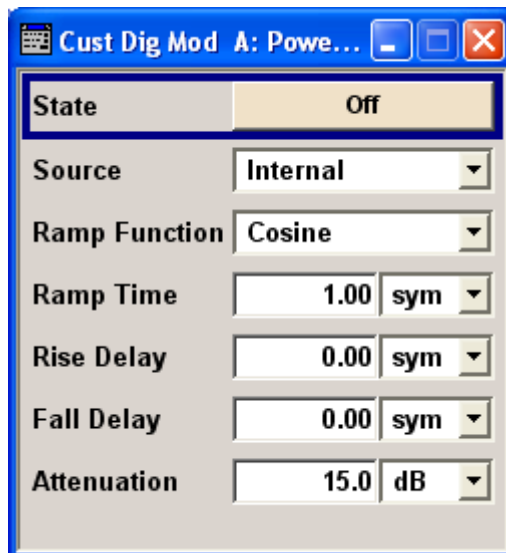

#### State

Enables/disables power ramping.

Remote command:

`[ :SOURce<hw> ] :BB:DM:PRAMP [ :STATe ]` on page 582

#### Source

Enters the source for the power ramp control signals.

"Internal" The control signals in the internal control list are used for control purposes.

See also "[Control and Marker List Editor](#)" on page 283.

The signals are output on the LEV\_ATT and BURST pin on the AUX I/O interface of path A.

In the case of two-path instruments, the path B signal can be placed on one of the USER interfaces.

"External Digital" The control signal is fed in via the AUX I/O interface.

For two-path instruments, path A = LEV-ATT pin, path B = user-definable USER pin or USER connector.

Remote command:

`[ :SOURce<hw> ] :BB:DM:PRAMP :SOURce` on page 581

#### Ramp Function

Selects the ramp function that describes the shape of the rising and falling edges during power ramp control, see [Figure 5-25](#).

"Linear" The transmitted power rises and falls linear fashion.



"Cosine" The transmitted power rises and falls with a cosine-shaped edge. This gives rise to a more favorable spectrum than the "Linear" setting.

Remote command:

[ :SOURce<hw> ] :BB:DM:PRAMP:SHAPE on page 581

### Ramp Time

Enters the power ramping rise time and the fall time for a burst. The setting is expressed in symbols. See also [Figure 5-25](#).

Remote command:

[ :SOURce<hw> ] :BB:DM:PRAMP:TIME on page 582

### Rise Delay

Sets the offset in the rising edge of the envelope at the start of a burst, see [Figure 5-25](#).

A positive value gives rise to a delay (the envelope length decreases) and a negative value causes an advance (the envelope length increases). The setting is expressed in symbols.

Remote command:

[ :SOURce<hw> ] :BB:DM:PRAMP:RDElay on page 581

### Fall Delay

Sets the offset in the falling edge of the envelope at the end of a burst, see [Figure 5-25](#).

A positive value gives rise to a delay, the envelope length increases and a negative value causes an advance (the envelope length decreases). The setting is expressed in symbols.

Remote command:

[ :SOURce<hw> ] :BB:DM:PRAMP:FDElay on page 581

### Attenuation

Determines the level by that the average signal level is attenuated during the signal attenuation period, during the time the "Lev\_Att" signal is high. See also [Figure 5-24](#).

For information about the required control signal LEV\_ATT, refer to ["Power Ramping and Level Attenuation"](#) on page 250.

The LEV\_ATT control signal is defined in "Control Data Editor" or supplied via the LEV\_ATT pin on the AUX I/O interface.

In case of two-path instruments, the LEV\_ATT control signal is supplied via the LEV\_ATT pin for path A or via a user-defined USER pin for path B.

Remote command:

[ :SOURce<hw> ] :BB:DM:PRAMP:ATTenuation on page 580

### Trigger/Marker/Clock

The "Trigger/Marker/Clock" dialog is accessed via the "Custom Digital Modulation" main menu.

The "Trigger In" section is where the trigger for the modulation signal is set. Various parameters will be provided for the settings, depending on which trigger source - internal or external - is selected. The current status of signal generation ("Running" or "Stopped") is indicated for all trigger modes.

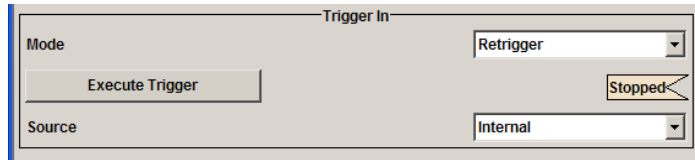

The "Marker Mode" section is where the marker signals at the MARKER output connectors are configured.

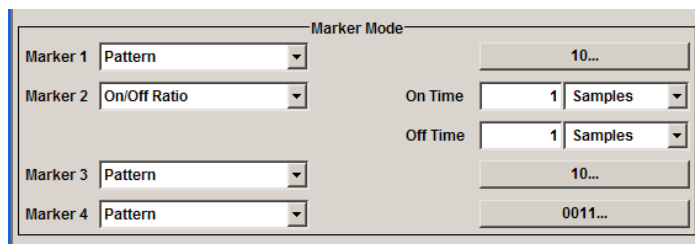

The "Marker Delay" section is where a marker signal delay can be defined, either without restriction or restricted to the dynamic section, i.e., the section in which it is possible to make settings without restarting signal and marker generation.

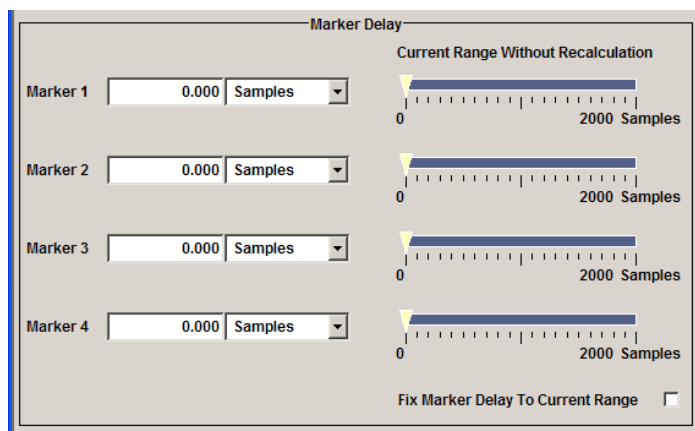

The "Clock Settings" section is where the clock source is selected and - in the case of an external source - the clock type.

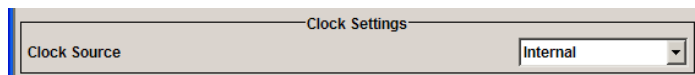

The "Global Trigger/Clock Settings" button leads to a submenu for general trigger, clock and external input settings.



### Trigger In

The "Trigger In" section is used to configure the trigger signal for the digital modulation. The current status of signal generation is indicated for all trigger modes.

### Trigger Mode

Selects trigger mode.

"Auto"	The digital modulation signal is generated continuously.
"Retrigger"	The digital modulation signal is generated continuously. A trigger event (internal with "Execute Trigger" or external) causes a restart.
"Armed_Auto"	The digital modulation signal is generated only when a trigger event occurs. Then the digital modulation signal is generated continuously. Button "Arm" stops signal generation. A subsequent trigger event (internal with "Execute Trigger" or external) causes a restart.
"Armed_Retrigger"	The digital modulation signal is generated only when a trigger event occurs. Then the signal is generated continuously. Every subsequent trigger event (internal with "Execute Trigger" or external) causes a restart. The button "Arm" stops signal generation. A subsequent trigger event (internal with "Execute Trigger" or external) causes a restart.
"Single"	The digital modulation signal is generated only when a trigger event occurs. Then the signal is generated once to the length specified at "Signal Duration". Every subsequent trigger event (internal with "Execute Trigger" or external) causes a restart.

Remote command:

[\[:SOURce<hw>\]:BB:DM\[:TRIGger\]:SEquence](#) on page 570

### Trigger Signal Duration

Enters the length of the signal sequence to be output in the "Single" trigger mode. The input is to be expressed in symbols.

Remote command:

[\[:SOURce<hw>\]:BB:DM:TRIGger:SLENgth](#) on page 567

### Running - Stopped

Displays the status of signal generation for all trigger modes. This display appears only when Custom Dig Mod is enabled (State On).

"Running"	The digital modulation signal is generated; a trigger was (internally or externally) initiated in triggered mode. If Armed_Auto and Armed_Retrigger have been selected, generation of signals can be stopped with the "Arm" button. A new trigger (internally with "Execute Trigger" or externally) causes a restart.
"Stopped"	The signal is not generated, and the instrument waits for a trigger event (internal or external).

Remote command:

[\[:SOURce<hw>\]:BB:DM:TRIGger:RMODe?](#) on page 567

**Arm**

Stops signal generation. This button appears only with "Running" signal generation in the "Armed\_Auto" and "Armed\_Retrigger" trigger modes.

Signal generation can be restarted by a new trigger (internally with "Execute Trigger" or externally).

Remote command:

[\[:SOURce<hw>\]:BB:DM:TRIGger:ARM:EXECute](#) on page 562

**Execute Trigger**

Executes trigger manually. A manual trigger can be executed only when an internal trigger source and a trigger mode other than "Auto" have been selected.

Remote command:

[\[:SOURce<hw>\]:BB:DM:TRIGger:EXECute](#) on page 563

**Trigger Source**

Selects trigger source.

"Internal"	The trigger event is executed by "Execute Trigger". As a precondition a trigger mode other than "Auto" must be selected.
"Internal (Baseband A/B)"	The trigger event is executed by the trigger signal from the second path (two-path instruments only).
"External"	The trigger event is executed with the aid of the active edge of an external trigger signal. The trigger signal is supplied via the TRIGGER 1/2 connector. The polarity, the trigger threshold and the input impedance of the trigger input can be set in the "Global Trigger Settings" menu.

Remote command:

[\[:SOURce<hw>\]:BB:DM:TRIGger:SOURce](#) on page 568

**Sync. Output to External Trigger**

(enabled for "Trigger Source" External)

Enables/disables output of the signal synchronous to the external trigger event.

"On"

Corresponds to the default state of this parameter.

The signal calculation starts simultaneously with the external trigger event but because of the instrument's processing time the first samples are cut off and no signal is outputted. After elapsing of the internal processing time, the output signal is synchronous to the trigger event.

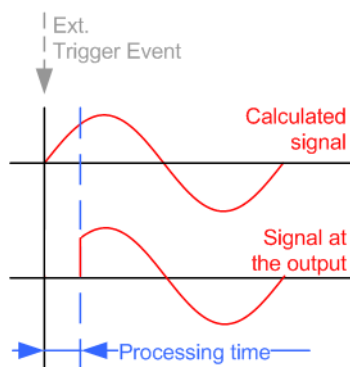

"Off"

The signal output begins after elapsing of the processing time and starts with sample 0, i.e. the complete signal is outputted.

This mode is recommended for triggering of short signal sequences with signal duration comparable with the processing time of the instrument.

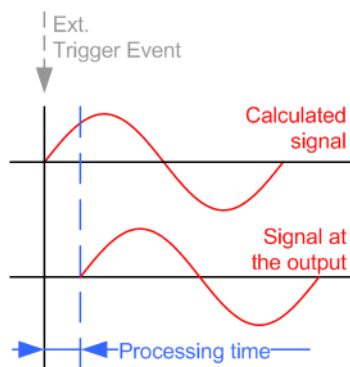

Remote command:

`[ :SOURce<hw> ] :BB:DM:TRIGger:EXTernal:SYNChronize:OUTPut`  
on page 563

### External Delay Unit

Determine whatever the trigger delay is expressed in samples or directly defined as a time period (seconds).

The parameter displays the delay converted in time.

Remote command:

`[ :SOURce<hw> ] :BB:DM:TRIGger:DELay:UNIT` on page 568

### Trigger Delay

Sets trigger signal delay in symbols on external triggering.

In case of two-path instruments, this applies on the internal triggering via the second path.

This enables the R&S AMU to be synchronized with the device under test or other external devices.

The parameter [Actual Trigger Delay](#) displays the delay converted in time.

**Note:** For two path instruments, the delay can be set separately for each of the two paths.

Remote command:

`[ :SOURce<hw> ] :BB:DM:TRIGger [ :EXTernal<ch> ] :DELay` on page 568

`[ :SOURce<hw> ] :BB:DM:TRIGger:OBASeband:DELay` on page 564

`[ :SOURce<hw> ] :BB:DM:TRIGger [ :EXTernal ] :TDELay` on page 569

`[ :SOURce<hw> ] :BB:DM:TRIGger:OBASeband:TDELay` on page 565

### Actual Trigger Delay

Displays the time (in seconds) an external trigger event or a trigger event from the other path is delayed by.

Remote command:

`[ :SOURce<hw> ] :BB:DM:TRIGger [ :EXTernal ] :RDELay?` on page 569

`[ :SOURce<hw> ] :BB:DM:TRIGger:OBASeband:RDELay?` on page 564

### Trigger Inhibit

(available on external triggering or triggering via the second path)

Sets the duration for inhibiting a new trigger event subsequent to triggering. The input is to be expressed in symbols.

In the "Retrigger" mode every trigger signal causes signal generation to restart. This restart is inhibited for the specified number of samples.

**Note:** For two-path instruments, the trigger inhibit can be set separately for each of the two paths.

Remote command:

`[ :SOURce<hw> ] :BB:DM:TRIGger [ :EXTernal<ch> ] :INHibit` on page 569

`[ :SOURce<hw> ] :BB:DM:TRIGger:OBASeband:INHibit` on page 565

### Marker Mode

Provides the settings necessary to define the marker output signal for synchronizing external instruments.

#### Marker x

Marker configuration for up to 4 marker channels. The settings are used to select the marker mode defining the shape and periodicity of the markers. The contents of the dialog change with the selected marker mode; the settings are self-explanatory.

All regular marker signals are described in "[Marker Modes](#)" on page 254.

Remote command:

`[ :SOURce<hw> ] :BB:DM:TRIGger:OUTPut<ch>:MODE` on page 571

`[ :SOURce<hw> ] :BB:DM:TRIGger:OUTPut<ch>:PULSe:DIVider` on page 572

`[ :SOURce<hw> ] :BB:DM:TRIGger:OUTPut<ch>:PATtern` on page 572

[\[:SOURce<hw>\]:BB:DM:TRIGger:OUTPut<ch>:OFFTime](#) on page 571

[\[:SOURce<hw>\]:BB:DM:TRIGger:OUTPut<ch>:ONTime](#) on page 572

### Marker x Delay

Defines the delay between the marker signal at the marker outputs relative to the signal generation start.

"Marker x" For the corresponding marker, sets the delay as a number of symbols.

Remote command:

[\[:SOURce<hw>\]:BB:DM:TRIGger:OUTPut<ch>:DELay](#) on page 566

"Current Range without Recalculation"

Displays the dynamic range within which the delay of the marker signals can be set without restarting the marker and the signal.

Move the setting mark to define the delay.

Remote command:

[\[:SOURce<hw>\]:BB:DM:TRIGger:OUTPut<ch>:DELay:MAXimum?](#) on page 566

[\[:SOURce<hw>\]:BB:DM:TRIGger:OUTPut<ch>:DELay:MINimum?](#) on page 566

"Fix marker delay to current range"

Restricts the marker delay setting range to the dynamic range.

Remote command:

[\[:SOURce<hw>\]:BB:DM:TRIGger:OUTPut:DELay:FIXed](#) on page 566

### Clock Settings

The clock source is selected in the Clock Settings section.

#### Clock Source

Selects the clock source (also see section "Clock Signals", page 2).

"Internal" The internal clock reference is used.

"External" The external clock reference is fed in as the symbol clock or a multiple thereof via the CLOCK connector.  
The chip rate must be correctly set to an accuracy of ( $\pm 2\%$  (see data sheet).

The polarity of the clock input can be changed with the aid of "Global Trigger/Clock/External Input" Settings.

In the case of two-path instruments, this selection applies to path A.

Remote command:

[\[:SOURce<hw>\]:BB:DM:CLOCK:SOURCE](#) on page 561

#### Clock Mode

Enters the type of externally supplied clock.

"Symbol" A symbol clock is supplied via the CLOCK connector.

- "Multiple Symbol" A multiple of the symbol clock is supplied via the CLOCK connector, the symbol clock is derived internally from this.  
The "Multiplier" window provided allows the multiplication factor to be entered.  
**Note:** This setting is not possible if the serial or parallel external data source is selected.
- "Bit" A bit clock is supplied via the CLOCK connector; the symbol clock is derived internally from this.  
**Note:** This setting is not possible if the serial or parallel external data source is selected.

Remote command:

`[ :SOURCE<hw> ] :BB:DM:CLOCK:MODE` on page 560

#### Symbol Clock Multiplier

Enters the multiplication factor for clock type "Multiple".

Remote command:

`[ :SOURCE<hw> ] :BB:DM:CLOCK:MULTIPLIER` on page 561

#### Measured External Clock

Displays the measured frequency of the external clock signal. This enables the user to permanently monitor the frequency of the externally introduced clock.

This information is displayed only if the external clock source has been selected.

Remote command:

`:CLOCK:INPut:FREQuency?` on page 465

#### Global Trigger/Clock/Input Settings

Calls the "Global Trigger/Clock/Input Settings" menu. This menu is used among other things for setting the trigger threshold, the input impedance and the polarity of the clock and trigger inputs.

In the case of two-path instruments, these settings are valid for both paths.

The parameters in this menu affect all digital modulations and standards, and are described in the [Chapter 5.2.3.9, "Global Trigger/Clock/External Input Settings"](#), on page 148.

Remote command:

n.a.

### 5.7.4 Arbitrary Waveform Generator ARB

The Arbitrary Waveform Generator (ARB) is an I/Q modulation source forming an integral part of the R&S AMU. It can be used to output any externally calculated modulation signals or internally generated multi carrier signals or waveform files.

The Arbitrary Waveform Generator is incorporated in the Baseband Generator (R&S AMU-B9/B10/B11) option. The Baseband Main Module (R&S AMU-B13) option is also required. The three Baseband Generator options feature different ARB memory



sizes (see data sheet). Apart from the memory size, however, the three options offer the same functionality, either one can be installed.

In the case of two-path instruments, at least one further Baseband Generator option is needed for waveform output in the second path. Using this option a waveform can be read in on path B and then either routed via path A or added to the signal on path A with a frequency offset that can be set.

When path B is fully expanded with a second option Baseband Main Module (R&S AMU-B13) the waveform can be output on I/Q Out B.



The signal output on I/Q Out B requires a second option for differential output (option AMU-B16, Differential I/Q Out) and a second option for digital output (option AMU-B18, Digital I/Q Out).

#### 5.7.4.1 Introduction

This chapter provides background information on the ARB functionality and the impact of the provided settings.

For description on the multi carrier, multi segment and multi carrier continuous wave functions, refer to:

- [Chapter 5.7.4.4, "Multi Carrier Waveforms"](#), on page 341
- [Chapter 5.7.4.3, "Multi Segment Waveforms"](#), on page 324
- [Chapter 5.7.5, "Multi Carrier Continuous Wave"](#), on page 354

#### Waveform Files Sources

The R&S AMU can replay any waveform file stored on a network drive but also generate and replay simple waveforms for test purposes.

A waveform is a file with specified file format containing raw IQ samples. The IQ values are calculated in advance and stored as waveform files with predefined extension \* .wv. When created by the R&S AMU, the instrument inserts a tagged waveform header at the beginning of each created ARB file. For more information, refer to [Chapter 7.4, "Waveform and List Format"](#), on page 432.

Depending on whether the R&S AMU creates the waveform files itself or not, two waveform files sources can be distinguished:

- Internally generated waveforms  
The ARB generator enables the calculation and the generation of multi segment and multi carrier waveform files as well as the build in function to create a test waveform (e.g. a sine or rectangle signal) and keep it as a file or in the RAM. Several digital standards provide the special function "Generate Waveform File" and enable the calculation and storage of the signal as a waveform file that can be afterwards processed by the ARB generator.
- Externally generated waveforms  
The ARB can also process externally generated waveform files e.g. the waveform files generated on a PC by the Windows software package R&S WinIQSIM2, the

software R&S ARB Toolbox, the R&S SMx-K6 Pulse Sequencer software or signals calculated using a mathematical program such as Matlab.

For more information also on the required options, refer to the Rohde&Schwarz web site at <http://www.rohde-schwarz.com>. See also the Application Note 1MA28, "IQWizard - I/Q Signal Measurement and Conversion".

The externally generated waveform files can be loaded into the instrument via one of the available interfaces (USB, LAN or GPIB). Usually, the waveform file is stored on one of the network drives which are accessible for the operating system.

### Playing and Streaming Waveform Files

Depending on the way the loaded waveforms are processed, an ARB works in one of the following modes:

- **Playback from the internal memory**  
In the most common case, the ARB generator plays back a waveform file with a selectable clock frequency. The R&S AMU loads the entire file into the ARB memory from where the IQ samples are played repeatedly.  
This is suitable for files of limited size, e.g. up to 256 MB for instruments equipped with option R&S AMU-B10.  
The maximum size for streaming and ARB files is also listed in the R&S AMU data sheet.
- **Streaming**  
For playing of larger waveform files, the R&S AMU provides the second ARB mode, the HDD streaming mode. In this mode, the instrument streams the modulation data direct from its hard drive (HDD). HDD streaming is recommended for processing of files that require more ARB memory than the currently installed one. The HDD streaming limits the sample rate to 1 MHz.

### ARB Test Signals

The following test signals are available:

- **Sine Test Signal:** Two sinewave signals with a selectable (but equal) number of samples per period and equal frequencies. When the generation is triggered, the number of samples per period, together with the frequency of the test signal, determines the ARB clock frequency: "Clock Frequency" = "Frequency" \* "Samples per Period".  
**Note:** Because the resulting clock rate must not exceed the maximum ARB clock rate (see data sheet), the number of sample values is automatically restricted depending on the selected frequency.  
The first sine signal is mapped on the I samples, the second on the Q samples. The two signals differ by a selectable phase offset. For a -90 deg offset, the result is a unit vector in the I/Q plane, rotating counter-clockwise and starting at I = 0, Q = -1. For a 0 deg offset, the I and Q samples are on the diagonal of a unit square (I(t) = Q(t)).

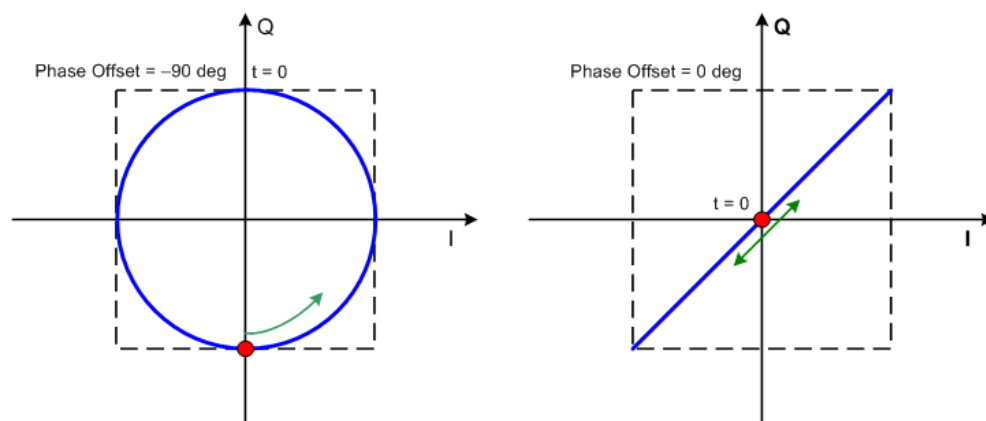

In general the I/Q samples are located on a deformed circle which is confined to the dashed square in the upper diagrams.

- Rect Test Signal:** Rectangle signal with selectable but equal On and Off periods and amplitude. The period is defined by the selected frequency:  $\langle \text{Period} \rangle = 1 / \text{"Frequency"}$ .  
 The signal is mapped on both the I and Q samples. This results in two distinct points in the I/Q plane. The "Offset DC" shifts both points along the diagonal  $I(t) = Q(t)$ .

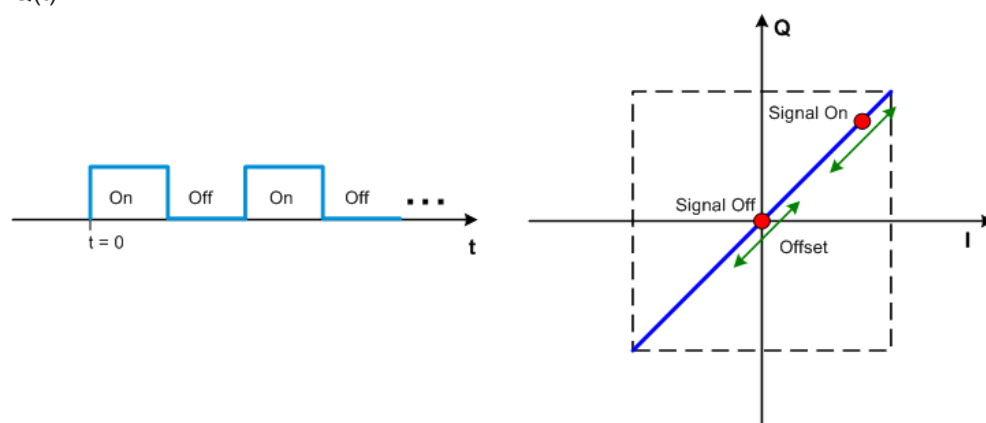

- Const I/Q Test Signal:** Continuous test signal with constant IQ and constant Clock Frequency of 10 KHz. The values for each I and Q components are selectable but constant. They are defined as a decimal number, which is decimal-to-binary converted internally. The signal is provided as a 16-bit wide digital signal for both I and Q channels.  
 Converted to analog, the signal is output directly at the BNC connectors I and Q outputs of the instrument.

### Waveform Sample Rate

The Arbitrary Waveform Generator includes a resampling unit that interpolates the input samples to reach a target digital output I/Q sample rate before digital-to-analog conversion (DAC). The input sample rate  $f_{\text{input}}$  is retrieved from the waveform (the default sample rate tag) or is defined by the corresponding parameter in the ARB user interface.

The [Figure 5-26](#) depicts the stages involved in the processing and resampling of a waveform in the ARB.

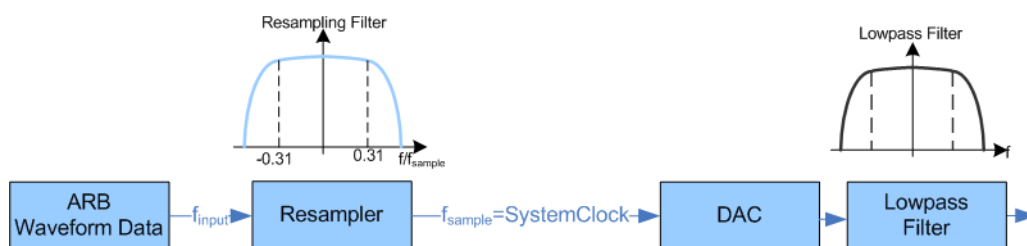

**Figure 5-26: Processing of the waveform files in the ARB**

The R&S AMU uses a 100 MHz system clock and a sample rate of 100 MSamples/s.

### Impact of the Resampling Lowpass Filter

As illustrated on the [Figure 5-26](#), the lowpass filter in the resampling stage is distortion-free for signals with the following maximum baseband bandwidth:

$$\text{BasebandBandwidth}_{\text{max}}, \text{ MHz} = 0.31 \times f_{\text{input}}$$

An externally created waveform file has to provide a sample rate  $f_{\text{input}}$  that is high enough for perfect signal reconstruction. For distortion-free resampling the lower bound of the required sample rate  $f_{\text{input}}$  is then calculated as follows:

$$f_{\text{input}} \geq \text{BasebandBandwidth} / 0.31$$

A modulation signal with a sample rate  $f_{\text{input}} = 100 \text{ MHz}$  is passed directly to the digital-to-analog converter (DAC), i.e. the resampling unit is bypassed. After the DAC, this signal features a  $\text{RFBandwidth}_{\text{max}} = 80 \text{ MHz}$ .

### Impact of the Oversampling Factor

Waveforms generated by the R&S WinIQSIM2 software can be optimized by choosing a suitable integer oversampling factor.

In comparison with conventional ARB generators that often assume oversampling factors of 4, the ARB generator of the R&S AMU requires low oversampling factors, but still providing excellent signal quality in terms of EVM and ACP.

A reduced sample rate saves significantly the amount of memory or allows an increased signal cycle time, vice versa.

### Impact on the Enabled Number of Marker Signals on the Waveform Length

The R&S AMU provides the possibility to define marker signals, that are sent to the marker outputs in synchronicity with the I/Q output signals. Marker signals can be either predefined or subsequently defined (see also [Chapter 5.7.2.8, "Marker Output Signals"](#), on page 253).

The I/Q data and marker data are located in separate memory areas of the SDRAM and can be independently configured whereas each marker signal requires one bit of the available memory size. In some cases, it might be useful to generate a modulation

signal without additional marker signals in order to increase the maximum waveform length.

The example below explains the dependency between the number of enabled marker signals, the available memory size and the resulting waveform length.

#### **Example: Calculating the maximum waveform length**

The calculation in this example is based on an instrument equipped with option R&S AMU-B10 (256 MSamples).

- Total Memory Size = 256 MB
- Required Memory Size (per complex sample) = 32 bits + 4 bits = 36 bits = 4.5 bytes, where:
  - the raw I/Q samples are stored as 16 bit values, i.e.  
for I/Q data = 2 x 16 bits = 32 bits (16 bits per I/Q channel)
  - each software defined marker requires 1 bit, i.e.  
for 4 enabled markers = 4 x 1 bit = 4 bits
- Maximum Waveform Length (with 4 markers) = 256 MB / 4.5 bytes = 56 MSamples
- Theoretical Maximum Waveform Length (no markers) = 256 MB / 4 bytes = 64 MSamples

Hence, a memory size of 256 MB yields a maximum waveform length of 56 MSamples if four markers are enabled. The maximum waveform length increases to 64 MSamples if the internal hardware markers are used, and the complete memory is available for I/Q data.

In instruments equipped with option R&S AMU-B11, the maximum available waveform length is 16 MSamples.

The minimum length of a waveform is 512 samples. A waveform is shorter than this value is automatically repeated until it reaches the minimum length.

#### **Specifying Delay and Inhibit Values in Time Units**

In the R&S AMU you can delay and suppress trigger events.

The delay and inhibit values are usually expressed in the units of the generated signal. To enable you to define the exact delay or inhibit period directly as a time value (e.g. in seconds), the instruments provide additional parameters. You can determine the units the values are defined in and the instrument calculates and displays the actual time delay/inhibit.

**Example:**

This example is based on a signal with 1 MHz clock frequency ("Baseband > ARB > Clock Frequency > 1 MHz").

Step 1: Enable the following settings:

- "Baseband > ARB > Trigger In > Mode > Armed Auto"
- "ARB > Trigger In > Source > External"
- "ARB > Trigger In > External Delay Unit > Samples"
- "ARB > Trigger In > External Delay > 100 Samples"

The parameter "Actual External Delay = 100 us" displays the time delay in seconds.

Step 2: Enable the following settings:

- "ARB > Trigger In > External Delay Unit > Time"
- "ARB > Trigger In > Specified External Delay > 10 us"  
Logically, the "Actual External Delay" changes to 10 us.

Step 3:

- Switch to "ARB > Trigger In > External Delay Unit > Samples".

The value of "ARB > Trigger In > External Delay" is 10 Samples.

Step 1	Step 2	Step 3



This principle applies for any external triggering and triggering via the other path(s).

**5.7.4.2 ARB User Interface**

To access the ARB dialog, select "Baseband > ARB" or use the MENU key under "Baseband".

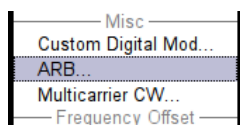

The "ARB" dialog is divided into an upper and a lower general part together with a "Marker" section.

The upper part of the menu is used for powering up, selecting and configuring ARB modulation.

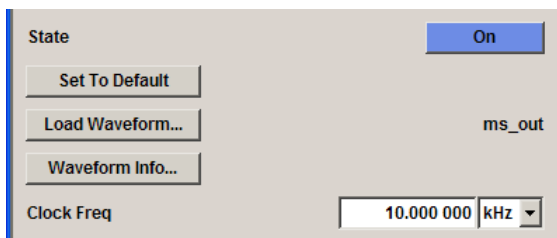

The section "Multi Segment Waveform Options" is only indicated if a multi segment waveform is loaded. In this part, the segment to be output is selected.

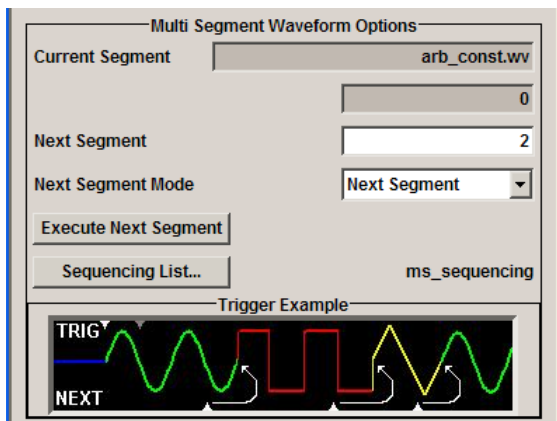

The buttons in the lower part of the menu open submenus for setting triggers and clocks, for configuring the test signal and for calculating a multi segment waveform or a multi carrier waveform.

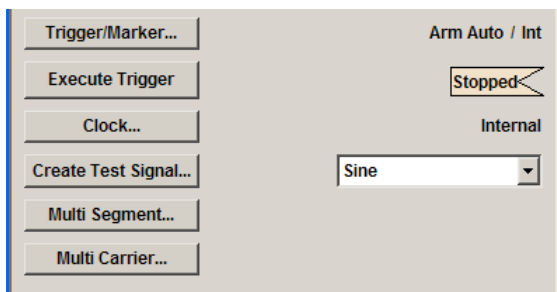

**ARB MOD Main Menu**

The upper part of the menu is used for powering up, selecting and configuring ARB modulation.

The lower part of the menu is used for setting triggers and clocks, as well as for file management. Test signals can be output for test purposes.

**Multi Segment Waveform Options**

The section "Multi Segment Waveform Options" of the menu is only displayed if a multi segment waveform is loaded.

The section comprises the settings necessary to adjust the trigger for the switch between the segments of a multi segment waveform. The parameters displayed depend on the selected trigger source.

The parameters in this sections are identical with the parameters in the section "Next Segment Trigger In" in the "Trigger/Marker" dialog; for detailed information see ["Next Segment Trigger In"](#) on page 312.

### State (ARB)

Enables/disables ARB modulation.

Switching on this standard turns off all the other digital standards and digital modulation types.

In case of two-path instruments, this affects the same path.

The output is based on the waveform file that is loaded. The name of the waveform file is displayed next to "Load Waveform".

If a multi segment waveform is loaded the section "Multi Segment Waveform Options" is indicated. In this section, the segment to be output is selected.

If no waveform file is loaded, ARB modulation cannot be powered up. "None" will be displayed next to "Load Waveform". An error message asks the user to load a waveform file:

"No waveform file loaded. ARB MOD state remains off. Please select a waveform file to load, before switching ARB MOD state on."

Remote command:

[\[:SOURce<hw>\]:BB:ARbitrary:STATe](#) on page 507

### Set To Default

Calls default settings. The values are shown in the [Table 5-12](#).

*Table 5-12: Default Settings*

Parameter	Value
State	Off
Clock Freq.	1 MHz
Trigger Mode	Auto
Trigger Source	Internal
Marker State	Off
Marker Mode	Unchanged
Clock Source	Internal

Remote command:

[\[:SOURce<hw>\]:BB:ARbitrary:PRESet](#) on page 507

### Load Waveform

Calls the "File Select "menu for loading the waveform file.



The files last used are listed in the "Recent Data Sets" section. The directory can be selected from the center left section. All waveform files (file extension \*.wv) available from the selected directory are listed on the right side. The file info (tag contents and multi segment state) for the selected file is displayed below the file section.

The "Select..." button selects the marked file. This file is loaded when the ARB modulation is enabled ("State On").

The "File Manager..." button leads to the file manager.

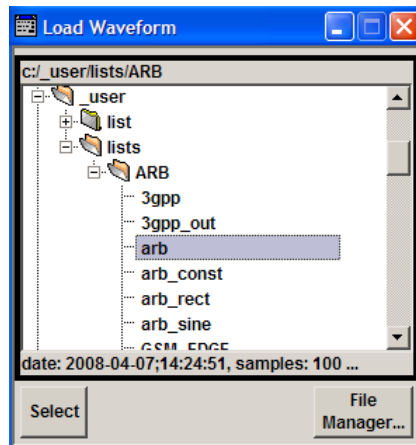

Remote command:

`[ :SOURce<hw> ] :BB:ARbitrary:WAVEform:SElect` on page 545

### Waveform Info

Opens a dialog with detailed information about the currently selected waveform.

The waveform information displayed in this dialog depends on whether the selected waveform file is a multi segment one or not. All parameters are read-only.

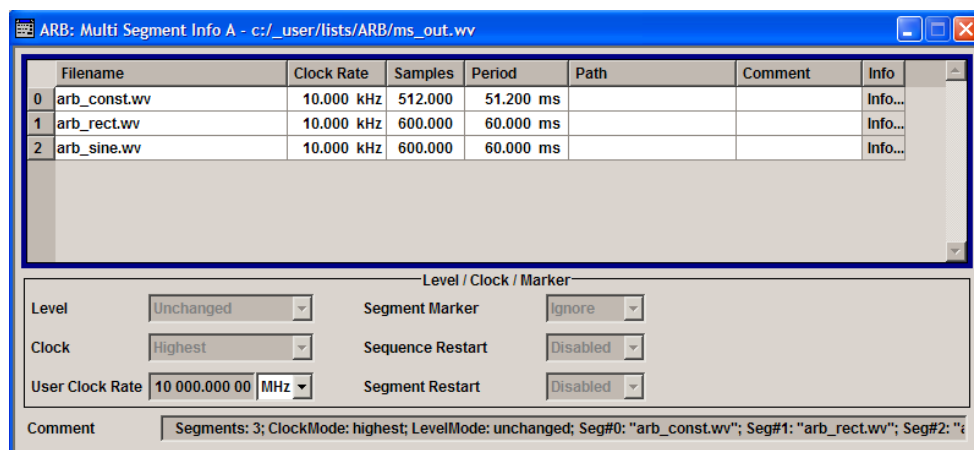

For non-multi segment waveform files, the values of the settings can be queried by means of the Tag commands (see [Chapter 7.4, "Waveform and List Format"](#), on page 432).

Remote command:

n.a.

**HDD Streaming**

Enables/disables the streaming of modulation data direct form the hard drive (HDD).

HDD streaming is recommended for processing of large files that require more ARB memory than the currently installed one.

HDD Streaming is enabled for waveform with "Clock Freq."  $\leq$  1 MHz and "Number of Samples"  $>$  16 MS.

Remote command:

`[ :SOURce<hw> ] :BB:ARbitrary:WAVEform:HDDStreaming:STATe` on page 544

**Streaming Buffer**

(enabled for waveform with "Clock Freq."  $\leq$  1MHz and "Number of Samples"  $>$  16MS)

Displays the filling level of the streaming buffer.

During normal operation, the streaming buffer level should have a value of 90% .. 100%. Buffer level around 0% indicates a buffer underrun and the signal processing will be interrupted.

Adjustment in the parameter value or state usually results in short decreasing of the streaming buffer level but this buffer state should not be misunderstood as buffer underrun.

Remote command:

`[ :SOURce<hw> ] :BB:ARbitrary:WAVEform:HDDStreaming:BLEVel?`

on page 543

**Clock Frequency**

Displays or enters the ARB output clock rate.

When the waveform file is loaded, this value is automatically set to the clock rate defined in the file (Clock tag). The user can subsequently alter the value if necessary.

When intending to work with an external clock source, the frequency to be applied must be entered here.

Remote command:

`[ :SOURce<hw> ] :BB:ARbitrary:CLOCK` on page 507

**Trigger/Marker**

Calls the Trigger and Marker menu.

This menu is used to select the trigger source, set the time delay on an external trigger signal and configure the marker output signals (see "[Trigger/Marker/Clock Settings](#)" on page 307).

Remote command:

n.a.

**Execute Trigger**

Executes trigger manually. A manual trigger can be executed only when an internal trigger source and a trigger mode other than Auto are selected.

Remote command:

`[ :SOURce<hw> ] :BB:ARbitrary:TRIGger:EXECute` on page 510

**Clock**

Calls the "Clock" menu. The "Clock" menu is used to select the clock source (see ["Clock Settings"](#) on page 319).

Remote command:

n.a.

**Create Test Signal...**

Selects the form of the test signal and calls the menu for generating it. A sinusoidal, rectangular or test signal with constant I/Q can be selected.

See the corresponding section for detailed description of the parameters for the selected test signal:

- ["Sine Test Signals"](#) on page 321
- ["Rect Test Signal"](#) on page 322
- ["Const IQ Test Signal"](#) on page 323

Remote command:

n.a.

**Multi Segment**

Calls the menu for calculating multi segment waveforms (see [Chapter 5.7.4.3, "Multi Segment Waveforms"](#), on page 324).

Remote command:

n.a.

**Multi Carrier**

Calls the menu for calculating multi carrier waveforms (see [Chapter 5.7.4.4, "Multi Carrier Waveforms"](#), on page 341).

Remote command:

n.a.

**Trigger/Marker/Clock Settings**

To access this dialog, select "Main Menu > Trigger/Marker".

The "Trigger In" section is where the trigger for the signal is set. Various parameters will be provided for the settings, depending on which trigger source - internal or external - is selected. The current status of signal generation ("Running" or "Stopped") is indicated for all trigger modes.

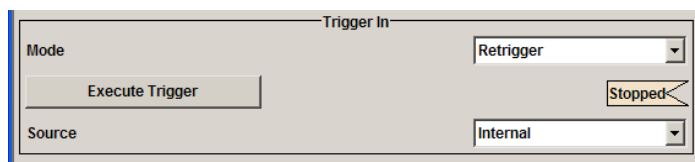

The "Next Segment Trigger In" is where the segment triggering is configured. This section is enabled only for multi segment waveforms.

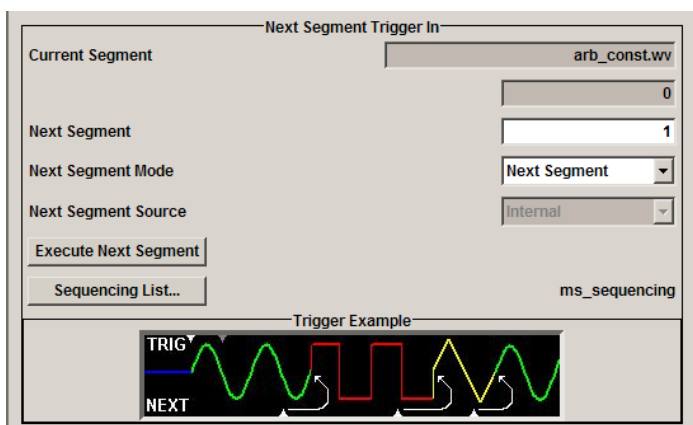

The "Marker Mode" section is where the marker signals at the MARKER output connectors are configured.

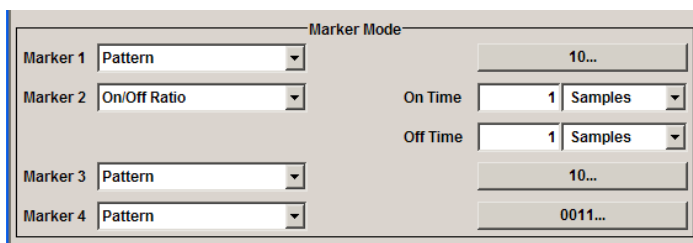

The "Marker Delay" section is where a marker signal delay can be defined, either without restriction or restricted to the dynamic section, i.e., the section in which it is possible to make settings without restarting signal and marker generation.

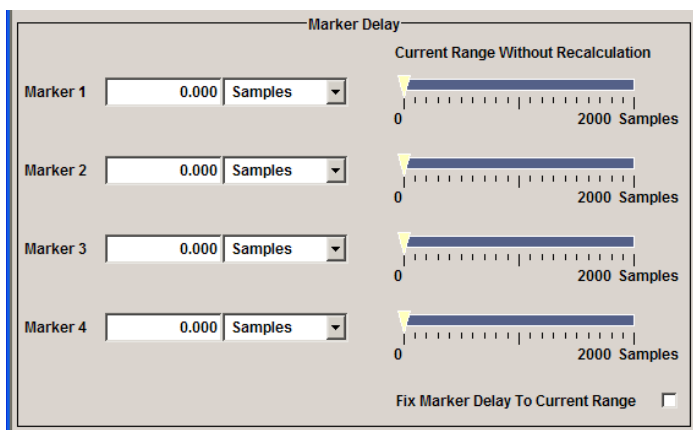

The "Clock Settings" section is where the clock source is selected and - in the case of an external source - the clock type.

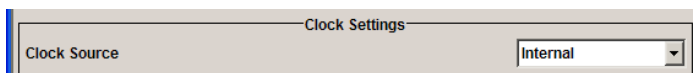

The buttons in the last section lead to submenu for general trigger, clock and mapping settings.

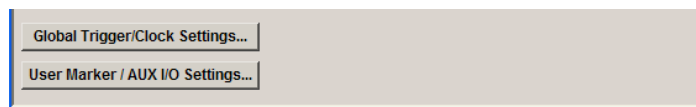

## Trigger In

The "Trigger In" section is where the trigger for the signal is set. Various parameters will be provided for the settings, depending on which trigger source - internal or external - is selected. The current status of signal generation ("Running" or "Stopped") is indicated for all trigger modes.

### Trigger Mode

Selects trigger mode.

The trigger mode determines the effect of a trigger on the signal generation.

"Auto"	The signal is generated continuously.
"Retrigger"	The signal is generated continuously. A trigger event (internal or external) causes a restart.
"Armed_Auto"	The signal is generated only when a trigger event occurs. Then the signal is generated continuously. Button "Arm" stops signal generation. A subsequent trigger event (internal with "Execute Trigger" or external) causes a restart.
"Armed_Retrigger"	The signal is generated only when a trigger event occurs. Then the signal is generated continuously. Every subsequent trigger event causes a restart. Button "Arm" stops signal generation. A subsequent trigger event (internal with "Execute Trigger" or external) causes a restart.
"Single"	The signal is generated only when a trigger event occurs. Then the signal is generated once to the length specified at "Signal Duration". Every subsequent trigger event (internal with "Execute Trigger" or external) causes a restart.

Remote command:

[\[:SOURce<hw>\]:BB:ARbitrary\[:TRIGger\]:SEQUence](#) on page 517

### Signal Duration Unit

Defines the unit for the entry of the length of the signal sequence to be output in the "Single" trigger mode.

Remote command:

[\[:SOURce<hw>\]:BB:ARbitrary:TRIGger:SLUNit](#) on page 515

### Signal Duration

Defines the length of the signal sequence to be output in the "Single" trigger mode. The unit of the entry is defined under "Signal Duration Unit". It is then possible to output deliberately just part of the signal, an exact sequence of the signal, or a defined number of repetitions of the signal.

Remote command:

[\[:SOURce<hw>\]:BB:ARbitrary:TRIGger:SLENgth](#) on page 514

**Running/Stopped**

Displays the status of signal generation for all trigger modes. This display appears only when signal generation is enabled ("State" On).

"Running"	The waveform is output; a trigger was (internally or externally) initiated in triggered mode. If "Armed_Auto" and "Armed_Retrigger" have been selected, generation of signals can be stopped with the "Arm" button. A new trigger (internally with "Execute Trigger" or externally) causes a restart.
"Stopped"	The Waveform output is stopped. The instrument waits for an internal or external trigger event to restart. ARB modulation is disabled (State Off).

Remote command:

`[ :SOURce<hw> ] :BB:ARbitrary:TRIGger:RMODE?` on page 514

**Arm**

Stops waveform output. This button appears only with "Running" signal generation in the "Armed\_Auto" and "Armed\_Retrigger" trigger modes.

Signal output can be restarted by a new trigger (internally with "Execute Trigger" or externally).

Remote command:

`[ :SOURce<hw> ] :BB:ARbitrary:TRIGger:ARM:EXECute` on page 510

**Execute Trigger**

Executes trigger manually. A manual trigger can be executed only when an internal trigger source and a trigger mode other than "Auto" have been selected.

Remote command:

`[ :SOURce<hw> ] :BB:ARbitrary:TRIGger:EXECute` on page 510

**Trigger Source**

Selects trigger source. This setting is effective only when a trigger mode other than "Auto" has been selected.

"Internal"	The trigger event is executed by "Execute Trigger".
"Internal (Baseband A/B)"	(two-path instruments only) The trigger event is executed by the trigger signal from the second path. This makes it possible for instance to start the two paths synchronously or with a defined delay.
"External"	The trigger event is executed with the aid of the active edge of an external trigger signal. The trigger signal is supplied via the TRIGGER 1/2 connector. The polarity, the trigger threshold and the input impedance of the trigger input can be set in the "Global Trigger/Clock Settings" dialog. <b>Note:</b> For multi segment waveforms, an external trigger source can be used for cyclical output of the segments. Each trigger event starts the output of the next segment. After the last segment, the first segment is output again.

Remote command:

[\[:SOURce<hw>\]:BB:ARbitrary:TRIGger:SOURce](#) on page 515

### Sync. Output to External Trigger

(enabled for "Trigger Source > External")

Enables/disables output of the signal synchronous to the external trigger event.

"On"

Corresponds to the default state of this parameter.

The signal calculation starts simultaneously with the external trigger event but because of the instrument's processing time the first samples are cut off and no signal is outputted. After elapsing of the internal processing time, the output signal is synchronous to the trigger event.

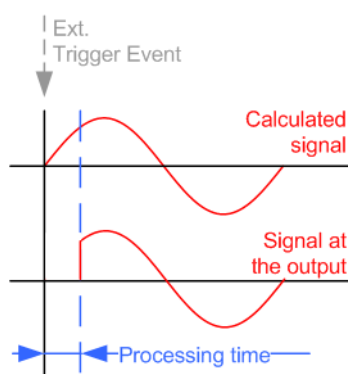

"Off"

The signal output begins after elapsing of the processing time and starts with sample 0, i.e. the complete signal is outputted.

This mode is recommended for triggering of short signal sequences with signal duration comparable with the processing time of the instrument.

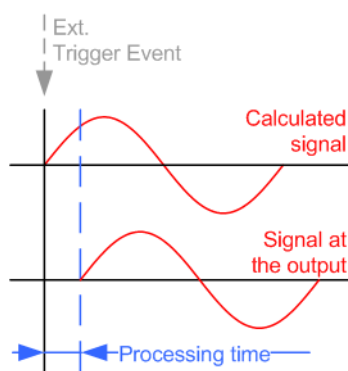

Remote command:

[\[:SOURce<hw>\]:BB:ARbitrary:TRIGger\[:EXTernal\]:SYNChronize:OUTPut](#) on page 510

### External Delay Unit

Determine whatever the trigger delay is expressed in samples or directly defined as a time period (seconds).

The parameter displays the delay converted in time.

Remote command:

[\[:SOURce<hw>\]:BB:ARbitrary:TRIGger:DElay:UNIT](#) on page 516

### Trigger Delay

Sets the trigger signal delay in samples on external triggering or on internal triggering via the second path. This enables the R&S AMU to be synchronized with the device under test or other external devices.

The parameter [Actual Trigger Delay](#) displays the delay converted in time.

For two-path instruments, the delay can be set separately for each of the two paths.

Remote command:

[\[:SOURce<hw>\]:BB:ARbitrary:TRIGger\[:EXternal<1|2>\]:DElay](#)  
on page 516

[\[:SOURce<hw>\]:BB:ARbitrary:TRIGger:OBASeband:DElay](#) on page 511

[\[:SOURce<hw>\]:BB:ARbitrary:TRIGger\[:EXternal<1|2>\]:TDElay](#)  
on page 516

[\[:SOURce<hw>\]:BB:ARbitrary:TRIGger:OBASeband:TDElay](#) on page 512

### Actual Trigger Delay

Displays the time (in seconds) an external trigger event or a trigger event from the other path is delayed by.

Remote command:

[\[:SOURce<hw>\]:BB:ARbitrary:TRIGger\[:EXternal<1|2>\]:RDElay?](#)  
on page 516

[\[:SOURce<hw>\]:BB:ARbitrary:TRIGger:OBASeband:RDElay?](#) on page 511

### Trigger Inhibit

Sets the duration for inhibiting a new trigger event subsequent to triggering. The input is to be expressed in samples.

In the "Retrigger" mode, every trigger signal causes signal generation to restart. This restart is inhibited for the specified number of samples.

This parameter is only available on external triggering or on internal triggering via the second path. For two-path instruments, the trigger inhibit can be set separately for each of the two paths.

Remote command:

[\[:SOURce<hw>\]:BB:ARbitrary:TRIGger\[:EXternal<1|2>\]:INHibit](#)  
on page 517

[\[:SOURce<hw>\]:BB:ARbitrary:TRIGger:OBASeband:INHibit](#) on page 512

### Next Segment Trigger In

The section "Next Segment Trigger" In of the menu is only displayed if a multi segment waveform is loaded.

The section comprises the settings necessary to adjust the trigger for the switch between the segments of a multi segment waveform. The parameters displayed depend on the selected trigger source.



### Current Segment

Indication of the waveform segment (segment file name and index) that is currently output.

Remote command:

`[ :SOURce<hw> ] :BB:ARbitrary:WSEgment?` on page 546

`[ :SOURce<hw> ] :BB:ARbitrary:WSEgment:NAME?` on page 553

### Next Segment

Selects the waveform segment to be output next. It determines the start segment when switching on the ARB and enables switchover to any other segment.

The switchover is performed either after receiving an external next segment trigger event or, for the internal trigger case, by changing the segment index in the "Next Segment" field. The definition whether the new segment is generated immediately or only after the previous segment has been fully generated (wrap around) is determined by the parameter [Next Segment Mode](#).

The segment currently being output (segment index and file name) is displayed at "Current Segment". The subsequent trigger event after the last segment causes the first segment to be output again.

Remote command:

`[ :SOURce<hw> ] :BB:ARbitrary:WSEgment:NEXT` on page 554

### Next Segment Mode

Sets the segmented trigger mode of a multi segment waveform, i.e. defines the way the **switch over between the segments** in a multi segment waveform will be executed:

- In "Same Segment" mode, the processing of the multi segment waveform file is similar to the processing of a non-multi segment waveform, i.e. there is no switching to consecutive segment the upon receiving of a trigger event. Switching between the segments is triggered by changing the segment index in the "Next Segment" field.
- When "Next Segment" is selected, the current segment ceases to be output as soon as a trigger event for a new segment occurs, and the new segment starts to be output after a system-imposed signal gap. The following figure shows an example of the transition from a sinewave signal segment to a sawtooth segment (1 channel, above) in the case of next segment external triggering (below).

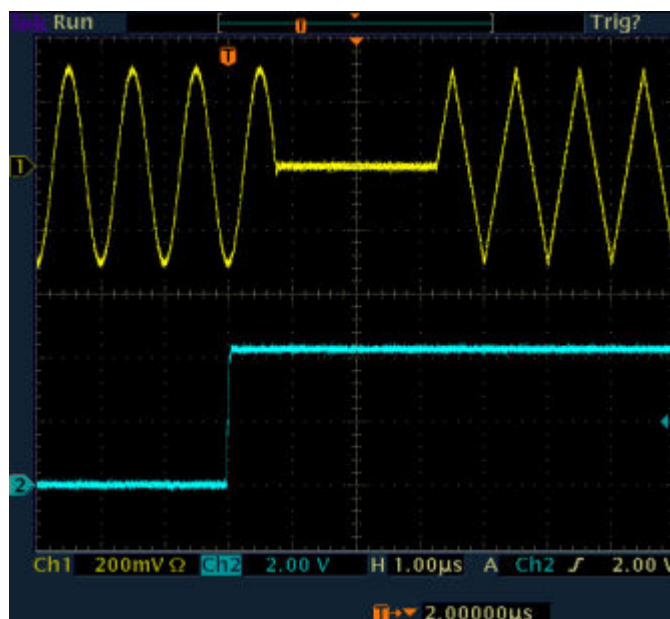

- When "Next Segment" Seamless is selected and a new segment trigger event occurs, the new segment is not output until the whole of the current segment has been output (wrap around). In this case the signal transition is seamless. As a prerequisite for a seamless switchover, all segments must have the same sample rate. The following figure shows an example of the seamless transition from a sinewave signal segment to a sawtooth segment (1 channel, above) in the case of next segment external triggering (below).

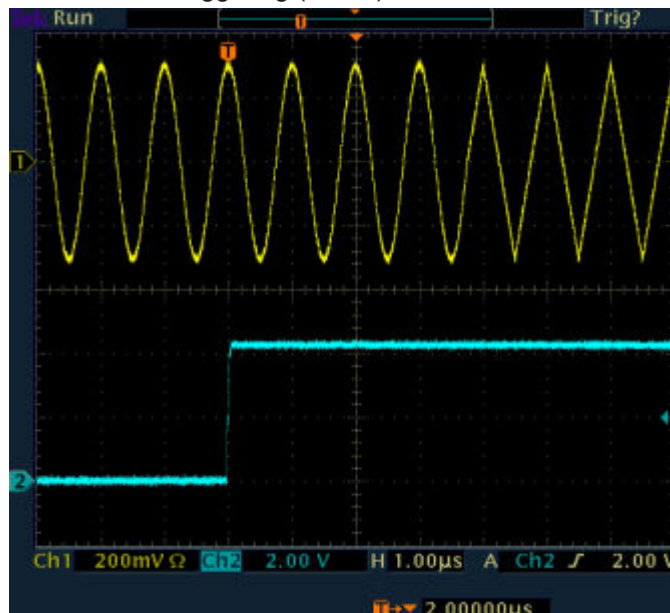

The regular trigger mode for starting the waveform generation and **triggering the whole multi segment sequence** is set with the parameters in the "Trigger In" section of the "Trigger/Marker/Clock" dialog.

The segment currently being output is displayed at "Current Segment".

The "Trigger Example" graph displays schematically the waveform output, depending on the activated trigger and the next segment settings.

"Same Segment"

Depending on the trigger setting, the currently selected segment is continuously output either immediately or after a trigger event.

Signal generation takes place differently according to the trigger selected in the "Trigger In" section:

- In the case of "Trigger = Auto", output starts at once and the segment is generated continuously. Trigger events are ignored. If the segment is changed in "Next Segment", output of the current segment is stopped and the new segment is output immediately, following a system-imposed signal gap (see above).
- In the case of "Trigger = Armed\_Auto", output starts after the first trigger event. The segment is then generated continuously. Further trigger events are ignored. If the segment is changed in "Next Segment", signal output is stopped and the new segment is not output until a trigger occurs.
- In the case of "Trigger = Retrigger", output starts at once and the segment is generated continuously, a trigger event causes a restart. If the segment is changed in "Next Segment", output of the current segment is stopped and the new segment is output immediately, following a system-imposed signal gap (see above).
- In the case of "Trigger = Armed\_Retrigger", output starts after the first trigger event. The segment is then generated continuously. Further trigger events cause a restart. If the segment is changed in "Next Segment", signal output is stopped and the new segment is not output until a trigger occurs.
- In the case of "Trigger = Single", output starts after the first trigger event. The segment is then generated once. Further trigger events cause a restart. If the segment is changed in "Next Segment", signal output is not stopped. The new segment is not output until a trigger occurs.

## "Next Segment"

Depending on the trigger setting, the segment selected under "Next Segment" is output either immediately or after a trigger event.

- In the case of "internal Trigger = Auto", output starts at once and the segment is generated continuously.  
If the segment index is changed in "Next Segment", output of the current segment is stopped and the new segment is output immediately, following a system-imposed signal gap.
- In the case of "internal Trigger = Armed\_Auto", output starts after the first trigger event. The segment is then generated continuously.  
If the segment index is changed in "Next Segment", output of the current segment is stopped and the new segment is output immediately, following a system-imposed signal gap.
- In the case of "internal Trigger = Single", output starts after the first trigger event. The segment is then generated once. Further trigger events cause a restart.  
If the segment index is changed in "Next Segment", the new segment is not output until a trigger occurs.
- In the case of "External Trigger = Auto", output starts at once and the segment is generated continuously.  
Each trigger event switches over to outputting the subsequent segment, following a system-imposed signal gap.  
If the segment index is changed in "Next Segment", output of the current segment is stopped and the new segment is output immediately, following a system-imposed signal gap.  
The subsequent trigger event after the last segment causes the first segment to be output again.
- In the case of "External Trigger = Armed\_Auto", output starts after the first trigger event. The segment is then generated continuously.  
Each trigger event switches over to outputting the subsequent segment, following a system-imposed signal gap.  
If the segment is changed in Next Segment, signal output is stopped and the new segment is not output until a trigger occurs.  
The subsequent trigger event after the last segment causes the first segment to be output again.
- In the case of "External Trigger = Single", output starts after the first trigger event. The segment is then generated once.  
Each trigger event switches over to outputting the subsequent segment once.  
If the segment is changed in "Next Segment", signal output is not stopped. The new segment is not output until a trigger occurs.  
The subsequent trigger event after the last segment causes the first segment to be output again.  
The remaining trigger modes ("Retrigger" and "Armed\_Retrigger") are not available.

"Next Segment Seamless"	<p>The segment selected under "Next Segment" is output. This mode is only available if all segments have the same sample rate.</p> <ul style="list-style-type: none"> <li>• In the case of "Internal Trigger = Auto", output starts at once and the segment is generated continuously. If the segment is changed in "Next Segment", the new segment is output seamlessly after the output of the current segment is complete.</li> <li>• In the case of "internal Trigger = Armed_Auto", output starts after the first trigger event. The segment is then generated continuously. If the segment is changed in "Next Segment", signal output is stopped and the new segment is not output until a trigger occurs.</li> <li>• In the case of "External Trigger = Auto", output starts at once and the segment is generated continuously. Each trigger event switches over to outputting the subsequent segment once the output of the current segment has been completed. If the segment is changed in "Next Segment", the new segment is output seamlessly after the output of the current segment is complete.</li> <li>• In the case of "External Trigger = Armed_Auto", output starts after the first trigger event. The segment is then generated continuously. Each trigger event switches over to outputting the subsequent segment once the output of the current segment has been completed. If the segment is changed in "Next Segment", signal output is stopped and the new segment is not output until a trigger occurs.</li> </ul> <p>The remaining trigger modes ("Retrigger" and "Armed_Retrigger") are not available.</p>
"Sequencer"	<p>The waveform files are processed according to the order and repetition cycles defined in the special sequencing list file (*.wvs) assigned to the multi segment waveform file. This "play list" is defined in the <a href="#">Multi Segment Waveform Sequencing</a> dialog.</p> <p><b>Note:</b> This feature is disabled in case the segments in the multi segment waveform file have different clock rates.</p>

Remote command:

`[ :SOURCE<hw> ] :BB:ARbitrary:TRIGGER:SMODE` on page 515

#### Next Segment Source

Displays the next segment source, internal or external, as selected with the parameter "Trigger Source".

Remote command:

`[ :SOURCE<hw> ] :BB:ARbitrary:WSEgment:NEXT:SOURCE?` on page 554

**Execute Next Segment**

Triggers manually switchover to the subsequent segment in the multi segment file. A manual trigger can be executed only when an internal "Next Segment Source" has been selected.

To perform a switchover to any segment within the multi segment file, adjust the parameter "Next Segment".

This parameter is disabled, if a sequencing play list is enabled.

Remote command:

`[ :SOURce<hw> ] :BB:ARbitrary:WSEgment:NEXT:EXECute` on page 554

**Sequencing List**

Open a dialog box for defining the "play lists" (see ["Multi Segment Waveform Sequencing"](#) on page 337).

Remote command:

`[ :SOURce<hw> ] :BB:ARbitrary:WSEgment:SEquence:SElect` on page 555

**Trigger Example**

Displays an example of a multi segment waveform. The currently enabled trigger and next segment mode are considered. After the instrument switch on, the graph of the last loaded waveform is displayed.

**Note:** The curves plotted in this dialog box are textbook examples, "not measured" waveforms. They are intended to visualize the trigger and next segment settings more clearly.

Remote command:

n.a.

**Marker Mode**

Provides the settings necessary to define the marker output signal for synchronizing external instruments.

**Marker Mode**

Marker configuration for up to 4 marker channels. The settings are used to select the marker mode defining the shape and periodicity of the markers. The contents of the dialog change with the selected marker mode; the settings are self-explanatory.

**Note:** The marker trace in the waveform file remains unchanged. It is not overwritten, even if something else than "Unchanged" has been selected.

All regular marker signals are described in ["Marker Modes"](#) on page 254.

"Unchanged"     The marker signal remains unchanged as defined in the waveform file.

"Restart"         A marker signal is generated at the start of each ARB sequence. This marker mode is not enabled for multi segment waveforms.

Remote command:

`[ :SOURce<hw> ] :BB:ARbitrary:TRIGger:OUTPut<ch>:MODE` on page 518

`[ :SOURce<hw> ] :BB:ARbitrary:TRIGger:OUTPut<ch>:PULSe:DIVider` on page 520

[\[:SOURce<hw>\]:BB:ARbitrary:TRIGger:OUTPut<ch>:PULSe:FREQuency?](#)  
on page 520

[\[:SOURce<hw>\]:BB:ARbitrary:TRIGger:OUTPut<ch>:PATtern](#) on page 520

[\[:SOURce<hw>\]:BB:ARbitrary:TRIGger:OUTPut<ch>:OFFTime](#) on page 519

[\[:SOURce<hw>\]:BB:ARbitrary:TRIGger:OUTPut<ch>:ONTime](#) on page 519

### Marker Delay

The delay of the signals on the MARKER outputs is set in the "Marker Delay" section.

#### Marker x Delay

Enters the delay between the marker signal at the marker outputs and the start of the frame or slot.

The input is expressed as a number of symbols. If the setting "Fix marker delay to dynamic range" is enabled, the setting range is restricted to the dynamic range. In this range the delay of the marker signals can be set without restarting the marker and signal.

Remote command:

[\[:SOURce<hw>\]:BB:ARbitrary:TRIGger:OUTPut<ch>:DELay](#) on page 513

#### Current Range without Recalculation

Displays the dynamic range within which the delay of the marker signals can be set without restarting the marker and signal.

The delay can be defined by moving the setting mark.

Remote command:

[\[:SOURce<hw>\]:BB:ARbitrary:TRIGger:OUTPut<ch>:DELay:MINimum?](#)  
on page 513

[\[:SOURce<hw>\]:BB:ARbitrary:TRIGger:OUTPut<ch>:DELay:MAXimum?](#)  
on page 513

#### Fix marker delay to current range

Restricts the marker delay setting range to the dynamic range. In this range the delay can be set without restarting the marker and signal.

Remote command:

[\[:SOURce<hw>\]:BB:ARbitrary:TRIGger:OUTPut:DELay:FIXed](#) on page 512

### Clock Settings

The "Clock Settings" is used to set the clock source and a delay if required.

#### Clock Source

Selects the clock source.

"Internal"            The internal clock reference is used to generate the symbol clock.

"External" The external clock reference is fed in as the symbol clock or multiple thereof via the CLOCK connector.  
The symbol rate must be correctly set to an accuracy of +/-2 % (see data sheet).  
The polarity of the clock input can be changed with the aid of "Global Trigger/Clock Settings".  
In the case of two-path instruments this selection applies to path A.

Remote command:

`[ :SOURce<hw> ] :BB:ARbitrary:CLOCK:SOURce` on page 509

### Clock Mode

Enters the type of externally supplied clock.

"Sample" A sample clock is supplied via the CLOCK connector.

"Multiple Sample" A multiple of the sample clock is supplied via the CLOCK connector; the sample clock is derived internally from this.  
The "Multiplier" window provided allows the multiplication factor to be entered.

Remote command:

`[ :SOURce<hw> ] :BB:ARbitrary:CLOCK:MODE` on page 508

### Sample Clock Multiplier

Enters the multiplication factor for clock type "Multiple".

Remote command:

`[ :SOURce<hw> ] :BB:ARbitrary:CLOCK:MULTIplier` on page 508

### Measured External Clock

Provided for permanent monitoring of the enabled and externally supplied clock signal.

Remote command:

`CLOCK:INPut:FREQuency?`

### Global Settings

The buttons in this section lead to submenu for general trigger, clock and mapping settings.

### Global Trigger/Clock Settings

Calls the "Global Trigger/Clock/Input Settings" dialog.

This dialog is used among other things for setting the trigger threshold, the input impedance and the polarity of the clock and trigger inputs.

In the case of two-path instruments, these settings are valid for both paths.

The parameters in this menu affect all digital modulations and standards, and are described in [Chapter 5.2.3.9, "Global Trigger/Clock/External Input Settings"](#), on page 148.

### User Marker / AUX I/O Settings

Calls the "User Marker AUX I/O Settings" menu, used used to map the connector on the rear of the instruments.



See also [Chapter 5.2.3.11, "User Marker / AUX I/O Settings"](#), on page 151.

### Sine Test Signals

To access the "Sine Test Signals" dialog, in the "ARB MOD" dialog set the parameter "Create Test Signal" to Sine and press "Create Test Signal".

The menu can be used to configure a sinusoidal test signal. A sine wave is generated on the I path, and a sine wave of the same frequency but phase-shifted is generated on the Q path.

The signal actually set is displayed in graphical form in the center of the menu.

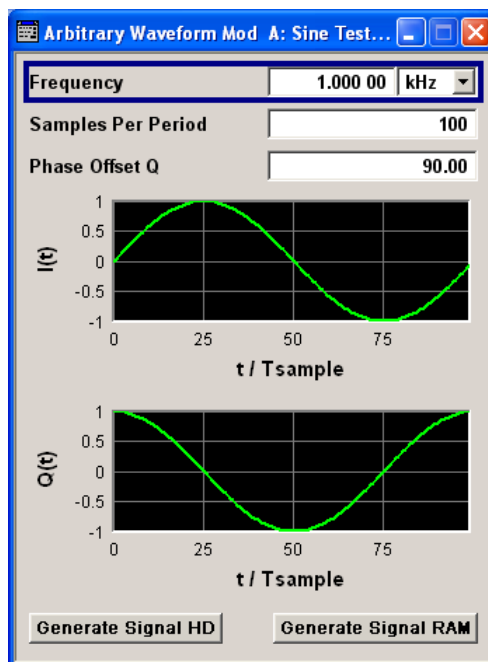

#### Frequency (Sine Test Signal)

Enters the frequency of the test signal.

Remote command:

[\[:SOURce<hw>\]:BB:ARbitrary:TSIGnal:SINE:FREQuency](#) on page 523

#### Samples per Period (Sine Test Signal)

Enters the number of sample values required from the sine wave per period.

The resulting clock rate must not exceed the maximum ARB clock rate (see data sheet). The number of sample values is automatically restricted by reference to the set frequency.

Remote command:

[\[:SOURce<hw>\]:BB:ARbitrary:TSIGnal:SINE:SAMPles](#) on page 524

#### Phase Offset Q (Sine Test Signal)

Enters the phase offset of the sinewave signal on the Q channel relative to the sinewave signal on the I channel.

Remote command:

[\[:SOURce<hw>\]:BB:ARbitrary:TSIGnal:SINE:PHASe](#) on page 524

### Generate Signal HD (Sine Test Signal)

Generates a signal and saves it to a file.

The File Select window opens automatically and the signal can be stored as a waveform file.

Remote command:

[\[:SOURce<hw>\]:BB:ARbitrary:TSIGnal:SINE:CREate:NAMed](#) on page 521

### Generate Signal RAM (Sine Test Signal)

Generates a signal and uses it as output straight away.

Remote command:

[\[:SOURce<hw>\]:BB:ARbitrary:TSIGnal:SINE:CREate](#) on page 521

### Rect Test Signal

To access the "Sine Test Signals" dialog, in the "ARB MOD" dialog set the parameter "Create Test Signal" to Rect and press "Create Test Signal".

The dialog can be used to configure a rectangular test signal. A rectangular test signal with a duty factor of 0.5 is created. Amplitude and offset are adjustable. Both paths, I and Q, get the same signal.

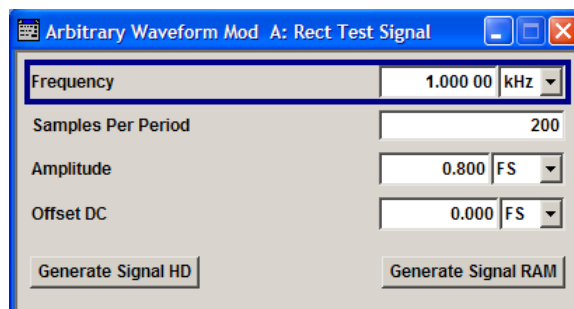

### Frequency (Rect Test Signal)

Enters the frequency of the test signal.

Remote command:

[\[:SOURce<hw>\]:BB:ARbitrary:TSIGnal:RECTangle:FREQuency](#) on page 522

### Samples per Period (Rect Test Signal)

Enters the number of sample values required for the rectangular signal per period.

The resulting clock rate must not exceed the maximum ARB clock rate (see data sheet). The number of sample values is automatically restricted by reference to the set frequency.

Remote command:

[\[:SOURce<hw>\]:BB:ARbitrary:TSIGnal:RECTangle:SAMPles](#) on page 523

### Amplitude (Rect Test Signal)

Enters the digital amplitude of the rectangular wave.

The abbreviation FS means full scale.

Remote command:

[\[:SOURce<hw>\]:BB:ARbitrary:TSIGnal:RECTangle:AMPLitude](#) on page 522

#### Offset DC (Rect Test Signal)

Enters a DC component.

Remote command:

[\[:SOURce<hw>\]:BB:ARbitrary:TSIGnal:RECTangle:OFFSet](#) on page 523

#### Generate Signal HD (Rect Test Signal)

Generates a signal and saves it to a file.

The File Select window opens automatically and the signal can be stored as a wave-form file.

Remote command:

[\[:SOURce<hw>\]:BB:ARbitrary:TSIGnal:RECTangle:CREate:NAMed](#) on page 521

#### Generate Signal RAM (Rect Test Signal)

Generates a signal and uses it as output straight away.

Remote command:

[\[:SOURce<hw>\]:BB:ARbitrary:TSIGnal:SINE:CREate](#) on page 521

#### Const IQ Test Signal

To access the "Sine Test Signals" dialog, in the "ARB MOD" dialog set the parameter "Create Test Signal" to Const I/Q and press "Create Test Signal".

The dialog can be used to configure a continuous test signal with constant IQ. The I and Q values for each path are adjustable but constant. The I and Q values are entered as a decimal number, which is decimal-to-binary converted internally. The signal is provided as a 16-bit wide digital signal for both I and Q channels.

Converted to analog the signal is output directly at the BNC connectors I and Q outputs of the instrument.

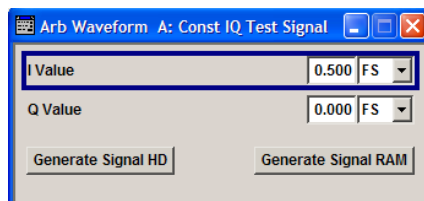

#### I Value (Const IQ Test Signal)

Enters the value for the I component of the test signal.

Remote command:

[\[:SOURce<hw>\]:BB:ARbitrary:TSIGnal:CIQ:I](#) on page 522

#### Q Value (Const IQ Test Signal)

Enters the value for the Q component of the test signal.

Remote command:

`[ :SOURce<hw> ] :BB:ARbitrary:TSIGnal:CIQ:Q` on page 522

#### **Generate Signal HD**

Generates a signal and saves it to a file.

The File Select window opens automatically and the signal can be stored as a waveform file.

Remote command:

`[ :SOURce<hw> ] :BB:ARbitrary:TSIGnal:CIQ:CREate:NAMed` on page 521

#### **Generate Signal RAM**

Generates a signal and uses it as output straight away.

Remote command:

`[ :SOURce<hw> ] :BB:ARbitrary:TSIGnal:CIQ:CREate` on page 521

### **5.7.4.3 Multi Segment Waveforms**

Modern chip technologies implement several communication standards within one chip and rise spacial verification and test requirements. To fulfill the requirements of these test systems and to enable rapid alternation between different waveforms with differing test signals, the R&S AMU provides the functionality to generate multi segment waveform files.

This section introduces the concept of the multi segment waveform files, together with description of the provided settings and some typical configuration examples.

#### **Required options**

Multi segment waveform files require the corresponding Digital Standard options (R&S AMU-K2xx) of all included standards.

#### **Introduction**

A multi segment waveform is a composed signal containing several multiple independent waveforms called segments. Each segment represents a completely independent waveform that can be output with its own marker and clock settings.

The [Figure 5-27](#) shows the principle of building a multi segment waveform.

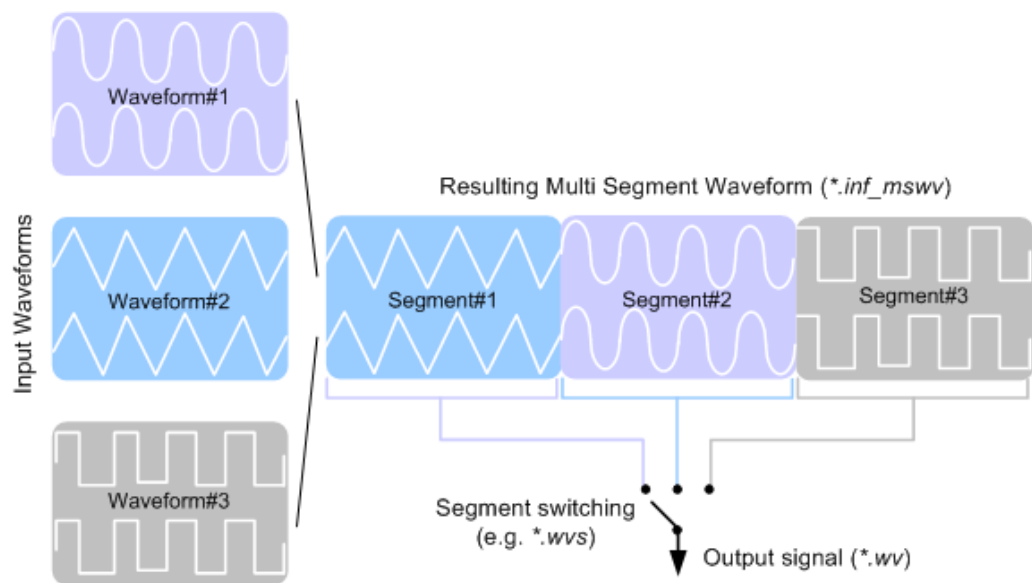

Figure 5-27: ARB Multi Segment Waveform Concept

It is also possible to create and output a blank segment, i.e. segments containing a zero signal.

Typical applications for the multi segment mode are described in section "[Typical Applications for Multi Segment Waveforms](#)" on page 340.

### Multi Segment Waveforms Processing

Processing of the waveform is triggered by the "Create" or "Create and Load" function. To process the waveform, the instrument loads the entire multi segment waveform into the memory. It is therefore possible to alternate between the individual waveforms without delay due to loading. You can define the output order of the segments, as well as the segment intended to be output at any given moment.

When the created waveform is loaded, the graphical interface displays information on clock rate, number of samples and creation day. Additionally, you can acquire information about the waveform in the dedicated "Waveform Info" dialog.

### The ARB Sequencer Mode

If very high switch over speeds are required, the test signals can be continuously scrolled through with the aid of an external trigger or by applying a predefined "Play List". The R&S AMU provides the possibility not only to define a sequence of different segment but also to determine whether a segment is played once or repeated several times and to adjust the transition between the segments.

For the correct and fast processing as well as for seamless transition between the multiple waveforms, segments with a common sample rate are required. If the combined waveforms features different sample rates, they should be adapted to a common sample rate by resampling. Another advantage of this procedure is the scaling of the instantaneous amplitude of the various waveforms to a common RMS level.

## File Concept

To provide flexible configuration, the building of a composed multi segment waveform file involves different stages; by completing of each of them, the R&S AMU creates and stores a dedicated file. The following files are used:

- **Configuration list:** is a dedicated file with details on how a multi segment waveform is made up from different waveforms, the level and the clock rate settings, and the file name. The file extension is `*.inf_mswv`.  
You can create any number of configurations as a basis for defining further multi segment waveforms.
- **Output file:** is the created output multi segment waveform file. The R&S AMU stores it under a user definable name; as with the standard waveforms, the used file extension is `*.wv`. The instrument appends additional information to the header of the composed waveform file, e.g. user comments.
- **Sequencing list:** are files created in the "Multi Segment Waveform Sequencing" dialog, i.e. when the ARB sequencer mode is used (see ["The ARB Sequencer Mode"](#) on page 325).  
The sequencing list file has an extension `*.wvs` and is automatically assigned to but independent from the multi segment file. By default, both files have the same name and are located in the same file directory. You can create more than one sequencing list file per multi segment waveform file.  
The sequencing list file carries information only about the segment number, the corresponding waveform file names are retrieved from the assigned multi segment waveform file, i.e. the same sequencing list file can be reused for different multi segment waveform files with the same number of segments.  
Changes and re-calculations of a multi segment waveform file cause a re-check whether the assigned sequencing list files are still valid. A message is displayed to inform about necessary corrections in the "play list".

## Impact of the Marker Settings

The general purpose of the marker signal is the triggering of the DUT (device under test) and the synchronization with other measurement instruments.

For better flexibility, the instrument provides several possibilities to define marker signals:

- **Segment markers**  
Because the multiple segments are stand alone waveforms, it might be that they already carry marker signals. Settings are provided to define how the instrument should process these available marker signal, to ignore them or to use them in the composed multi segment waveform.
- **Additional segment restart and sequence restart markers**  
Additional marker signal can be defined to restart the multi segment sequence or to restart each of the multiple segments. A marker output configured and defined for one of these purposes overwrites markers that use the same output connector and that are defined in the individual waveforms.

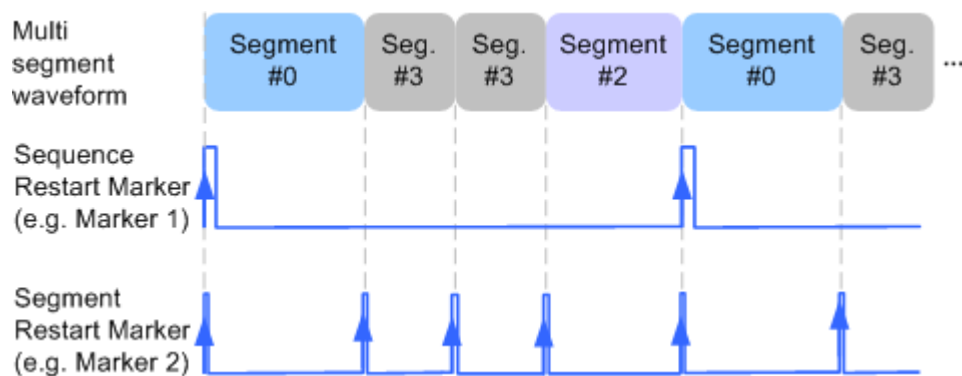

Figure 5-28: Example of marker signals

The segment begin is defined by the low-high slope of the marker. This applies for switching between two segments as well as in case of segment replay.

- General marker signals for the composed multi segment waveform  
The "ARB" dialog provides also access to the standard marker settings. Settings other than "unchanged" overwrite existing marker in the waveforms or markers defined for the multi segment waveform.

The [Figure 5-29](#) shows schematically how the instrument evaluates the priorities of the different marker signals, if multiple marker signals are mapped to the same connector.

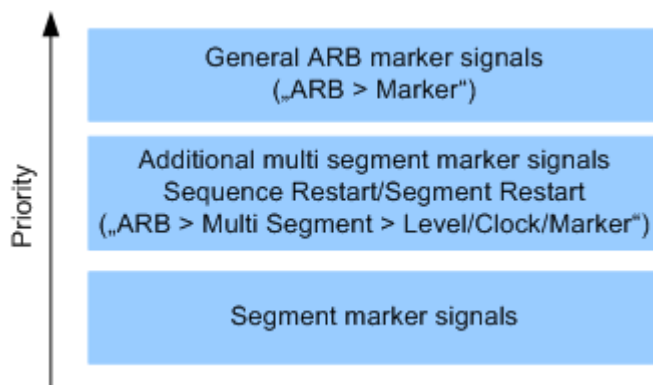

Figure 5-29: Marker priority used by assigning of marker signals to a hardware connector

### Impact of the Trigger Settings and Next Segment Settings

The ARB dialog is equipped with the standard (regular) trigger settings. These settings are provided for triggering of the composed multi segment waveform as a **sequence**, i.e. as one file.

This section focuses on the additional settings provided for triggering of the individual segments building the composed multi segment waveform. These settings are enabled and visible only if a multi segment waveform is loaded for processing. The settings are grouped in the "Multi Segment Waveform Options/Next Segment Trigger In" section.

The [Figure 5-30](#) is intended to explain how trigger events impact the processing of the multi segment waveforms.

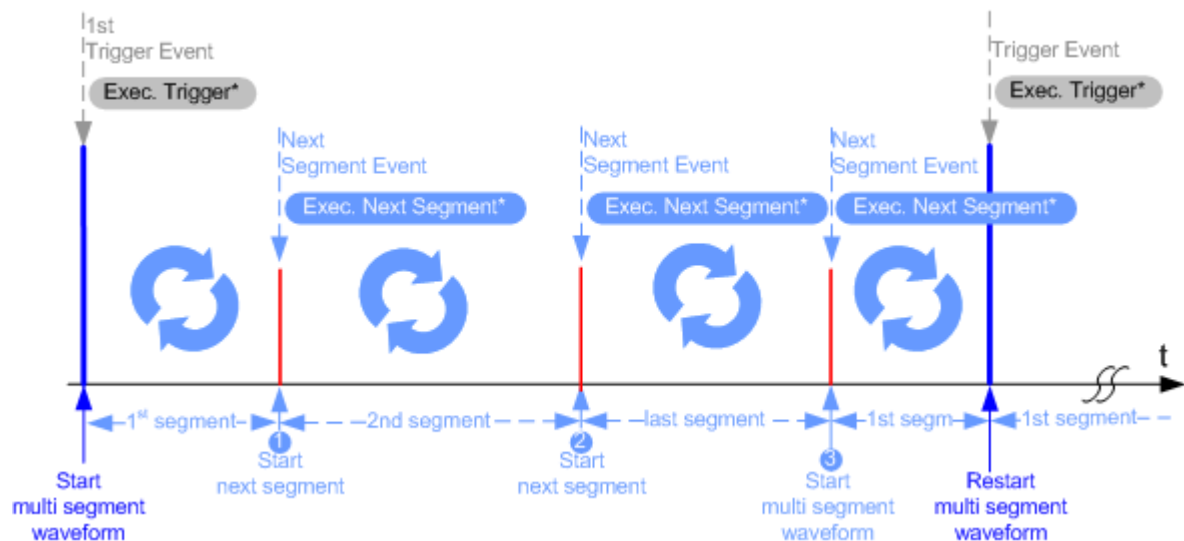

**Figure 5-30: Principle of segment triggering**

- \* = To simplify the description, an internal next segment trigger event ("Exec. Next Segment") and an internal trigger event ("Execute Trigger") are used; an external trigger event has the same effect on the signal generation.
- 1, 2 = Any next segment trigger event (internal or external) causes a switch over to the subsequent available segment in the waveform. The currently output segment (segment file name and segment index) is indicated at "Current Segment".
- 3 = When the last segment of the multi segment waveform has been output, the sequence starts again with the output of the first segment after the subsequent trigger event. Hence, a sequence of external next segment trigger events can be used to cyclically output the segments in the multi segment file.

### Defining Next Segment Source

As with the standard trigger system, provided are the following two sources for the next segment signal:

- **Internal:** the switch over to the subsequent segment is triggered manually by means of the "Execute Next Segment" function.  
To trigger a switch over to any segment within the multi segment waveform, change the value of the "Next Segment".
- **External:** the instrument expects an external trigger event (signal at the corresponding connector)

### Defining the Subsequent Segment

By default, the instrument replays the segments in incremental order, e.g. Segment#1, Segment#2, etc. If other order is required, use one of the following possibilities to define the segment to be played next:

- **Next Segment:** defines the subsequent segment while triggering the segments manually, i.e. by "Next Segment Source > Internal"
- **Sequencing List:** the subsequent segment is defined in the selected play list.



### Defining the Transition between the Segments

The R&S AMU provides the parameter "Next Segment Mode" to define the transition to the subsequent segment (see the two graphics below).

- **Next Segment:** by receiving a Next Segment Event, the ARB aborts immediately the playing of the current waveform and starts playing the next segment waveform (see [Table 5-13](#)).
- **Next Segment Seamless:** by receiving a Next Segment Event, the ARB completes the processing of the current waveform before starting the next segment waveform (see [Table 5-13](#)).

Use this setting to avoid signal gaps and wrap-around problems. Seamless transition requires segments with equal clock rates.

Another way to generate a multi segment signal without signal gaps between the segments is to use the provided ARB sequencer mode (see "[Multi Segment Waveform Settings](#)" on page 330).

The [Table 5-13](#) shows two examples of the transition from a sinewave signal segment to a sawtooth segment (I channel, upper curve) in the case of next segment external triggering. The left graphic displays an abrupt transition; the right graphic, the **seamless** transition case.

Table 5-13: Transition examples

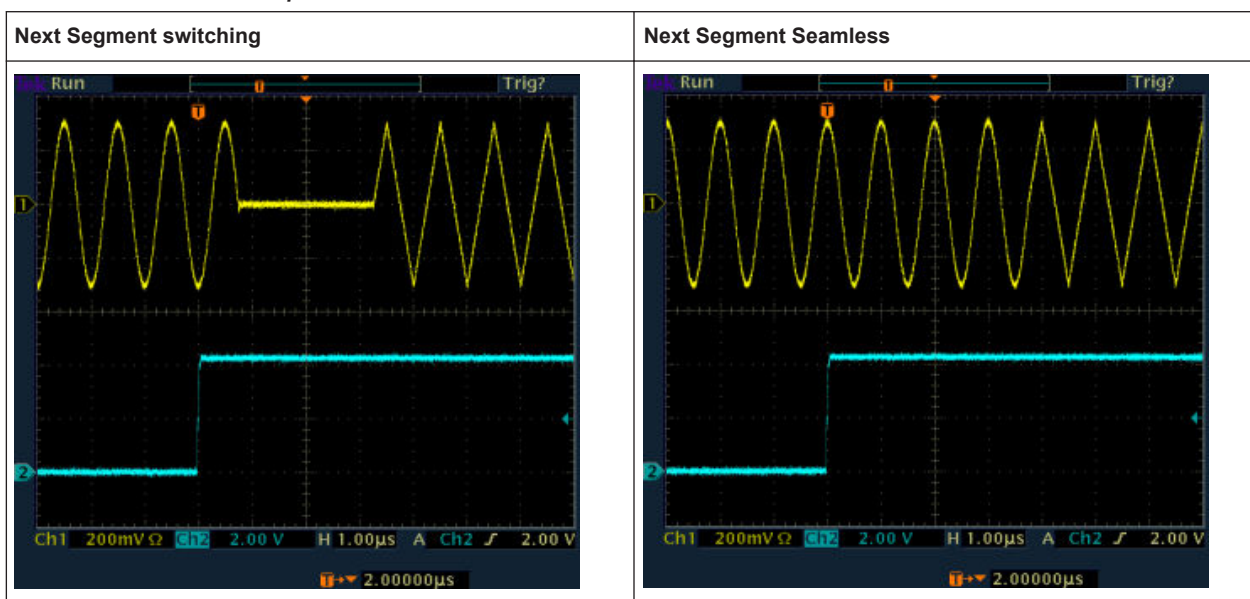

### Understanding the Trigger Examples

A simplified diagram in the ARB dialog is intended to explain the effect of the triggering on the signal processing. The currently enabled settings for trigger and next segment mode are considered.



The curves plotted in the dialog are textbook examples, "not measured" waveforms. They are intended to visualize the trigger and the next segment settings more clearly.

- The triangle on the top line denotes a trigger event. A filled triangle on the bottom line denotes a next segment event.
- A green sinewave (or other shape) over a full period indicates one replay cycle of a segment ; A shorter example signal indicates a replay cycle which was interrupted, e.g. due to a next segment event (compare the two graphics in [Table 5-14](#)).

**Table 5-14: Trigger examples in the "ARB" dialog**

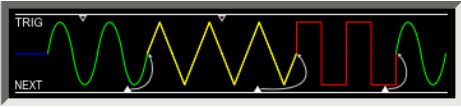
"Next Segment Mode = Next Segment"	"Next Segment Mode = Next Segment Seamless"
	

### Multi Segment Waveform Settings

To access the "Multi Segment" dialog, select "Baseband > ARB > Multi Segment...".

### Example

#### How to create multi segment waveform file

1. Select "New List" to create empty list.
2. Use the "Append" function to add two or more waveform files.
3. Adjust the "Level", "Clock" and "Segment Marker" settings.
4. Select the "Output File" and enter file name.
5. Select "Save List" to save the configuration.
6. Select "Create" or "Create and Load" to create and save the multi segment waveform.

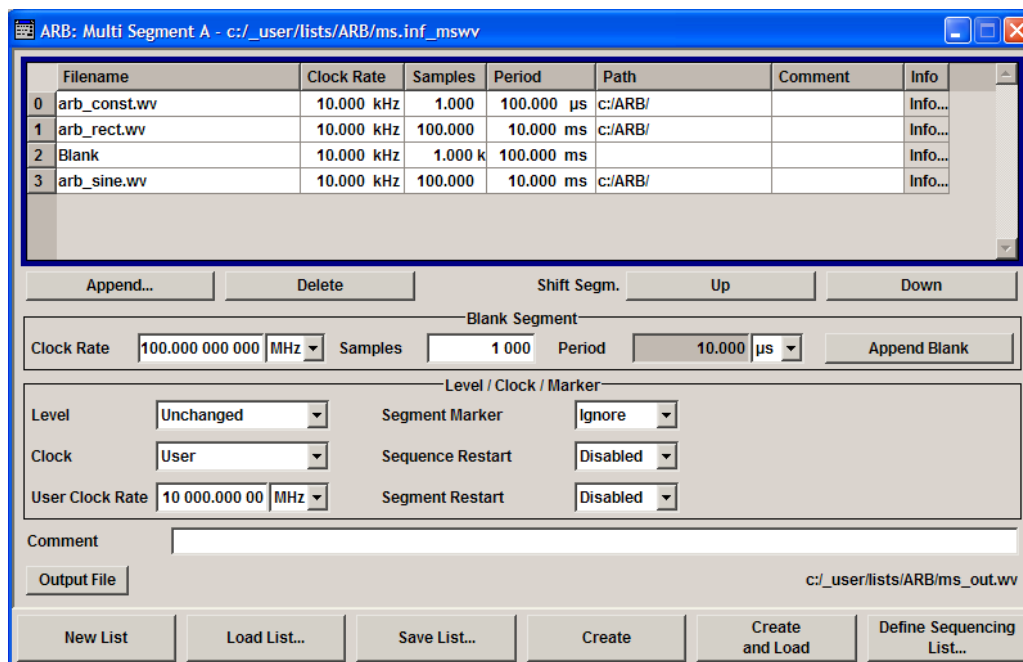

### Multi Segment File Contents

The upper part of the dialog provides the functions, necessary to create and adjust the contents of the multi segment file.

### Multi Segment Table

The table lists the individual waveforms (segments) of the selected multi segment waveform. The information about the segments is taken from the tags of the corresponding waveform files.

"Segment#"	Indication of segment index. The segment index is used to select the segment to be output. The segment index also defines the sequence of the output during triggering in the "Next Segment" or "Next Segment Seamless".
"Waveform"	Indication of the waveform file name of the segment.
"Clock Rate"	Indication of the clock rate of the segment.
"Samples"	Indication of the number of samples in the segment.
"Period"	Indication of the segment duration.
"Path"	Indication of the location of the waveform file used for the corresponding segment.
"Comment"	Indication of the comment on the segment.

"Info" Opens a dialog with detailed information about the currently selected waveform.

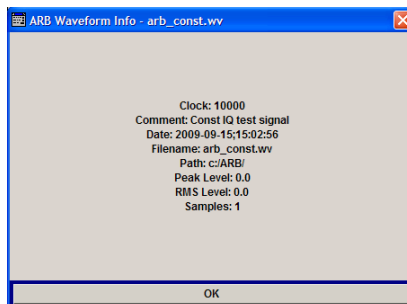

Remote command:  
n.a.

### Append

Opens the file menu to enter the file name of the waveform file to be appended.

Remote command:

`[ :SOURce<hw> ] :BB:ARBitrary:WSEGment:CONFigure:SEGment:CATalog?`  
on page 552

`[ :SOURce<hw> ] :BB:ARBitrary:WSEGment:CONFigure:SEGment:APPend`  
on page 552

### Delete

Deletes the selected segment.

Remote command:

`[ :SOURce<hw> ] :BB:ARBitrary:WSEGment:CONFigure:DELete` on page 549

### Shift Seg.# Up/Down

Shifts the selected segment up and down.

### Blank Segment

The Blank Segment section is where a blank segment can be configured.

#### Clock Rate

Selects the clock rate of the blank segment.

Remote command:

`[ :SOURce<hw> ] :BB:ARBitrary:WSEGment:CONFigure:BLANK:APPend`  
on page 547

#### Samples

Selects the number of samples for the blank segment.

Remote command:

`[ :SOURce<hw> ] :BB:ARBitrary:WSEGment:CONFigure:BLANK:APPend`  
on page 547

#### Period

Displays the resulting period for the blank segment.

Remote command:  
n.a.

### Append Blank

Adds the blank segment to the multi segment file.

Remote command:

`[ :SOURce<hw> ] :BB:ARbitrary:WSEgment:CONFigure:BLANK:APPend`  
on page 547

### Level / Clock /Marker

The Level/Marker/Clock section provides the parameters necessary to adjust the level, marker and clock settings for the selected multi segment waveform file.

#### Level

Defines the level mode for the multi segment waveform.

- |             |   |
|-------------|---|
| "Unchanged" | Concerning the level settings, the segments are output exactly as defined in the files. The "Level" display applies only to the segment with the highest rms value. In some circumstances the remaining segments are output at a lower level than that displayed. |
| "Equal RMS" | Segments are output so that all segments have the same rms value. The "Level" display applies to all segments.  |

Remote command:

`[ :SOURce<hw> ] :BB:ARbitrary:WSEgment:CONFigure:LEVel [ :MODE ]`  
on page 549

#### Clock

Selects the clock rate mode for the multi segment waveform.

- |             |   |
|-------------|---|
| "Unchanged" | A segment is output with the clock rate defined in the file. If segments have different clock rates, extended trigger mode "Next Segment" allows internal segment switchovers only ("Internal" trigger source).<br>Extended trigger mode "Next Segment Seamless" can only be selected if all segments have the same clock rate. |
| "Highest"   | All segments are output at the highest available clock rate. This mode provides very short switchover times between segments. The time for calculating the multi segment waveform is increased since the individual segments have to be resampled.  |
| "User"      | All segments are output at the clock rate defined in "User Clock". This mode provides very short switchover times between segments. The time for calculating the multi segment waveform is increased since the individual segments have to be resampled.  |

Remote command:

`[ :SOURce<hw> ] :BB:ARbitrary:WSEgment:CONFigure:CLOCK:MODE`  
on page 548

**User Clock Rate**

Defines the sample rate used for multi segment waveform output in case of Clock Mode "User".

Remote command:

`[ :SOURce<hw> ] :BB:ARbitrary:WSEgment:CONFigure:CLOCK` on page 548

**Segment Marker**

Defines the way the marker information within the separate segments is processed.

"Ignore"            The marker information carried in the individual segment waveform files is not considered.

"Take Over"        The output waveform file contains the marker information as configured in the individual waveform files.

Remote command:

`[ :SOURce<hw> ] :BB:ARbitrary:WSEgment:CONFigure:MARKer:MODE`  
on page 551

**Sequence Restart**

Enables/disables the generation of an additional marker restart signal in the output waveform file.

If additional marker generation is enabled, the existing marker signals in the individual segment waveform files are not considered.

"Disable"            No additional marker is generated.

"Marker  
1/2/3/4"            Generates a restart marker signal at the beginning of the first segment for the corresponding marker.  
Use this setting to generate a restart marker for the complete sequence.

Remote command:

`[ :SOURce<hw> ] :BB:ARbitrary:WSEgment:CONFigure:MARKer:FSEgment`  
on page 550

**Segment Restart**

Enables/disables the generation of an additional marker restart signal in the output waveform file.

If additional marker generation is enabled, the existing marker signals in the individual segment waveform files are not considered.

"Disable"            No additional marker is generated.

"Marker  
1/2/3/4"            Generates a restart marker signal at the beginning of each segment for the corresponding marker.  
The segment begin is defined by the low-high slope of the marker.  
This applies for switching between two segments as well as in case of segment replay.

Remote command:

`[ :SOURce<hw> ] :BB:ARbitrary:WSEgment:CONFigure:MARKer:ESEgment`  
on page 550

### Output File

In the Output File section, the output file name is specified and a comment can be added to the file.

### Comment

Adds a comment to the multi segment file.

Remote command:

`[ :SOURce<hw> ] :BB:ARBitrary:WSEgment:CONFigure:COMment` on page 549

### Output file

Opens the File menu, where the file name of the multi segment waveform which has to be calculated can be entered. The multi segment waveform is saved under this name by clicking the "Create" or "Create and Load" button.

A name must also be entered here before the list can be saved as a configuration file ("Save List"). In this case the name is needed for internal storage procedures. It is entered as the default name for the multi segment waveform file when loading the list.

Remote command:

`[ :SOURce<hw> ] :BB:ARBitrary:WSEgment:CONFigure:OFILe` on page 551

### Handling of Multi Segment Files

The buttons in this sections are provided for handling of the multi segment files.

### Save List

Saves the current entries of the table in a configuration file, including the level mode, clock mode, segment marker mode and output file name settings.

The file name is entered in the "File" menu. Configuration files have the file extension `*.inf_mswv`. They can be used later as the basis for further multi segment waveforms.

Before a multi segment configuration file can be saved, a file name must be entered in "Output File", since this is saved with the configuration file for internal purposes.

Remote command:

The configuration file to be used for the creation of the multi segment waveform is defined with the command:

`[ :SOURce<hw> ] :BB:ARBitrary:WSEgment:CREate`

or `[ :SOURce<hw> ] :BB:ARBitrary:WSEgment:CLoad`

The file name of the waveform file is always determined with the command [ :

`SOURce<hw> ] :BB:ARBitrary:WSEgment:CONFigure:OFILe`

### Load List

Opens the file menu to select the configuration file to be edited.

Remote command:

`[ :SOURce<hw> ] :BB:ARBitrary:WSEgment:CONFigure:CATalog?` on page 548

`[ :SOURce<hw> ] :BB:ARBitrary:WSEgment:CONFigure:SElect` on page 552

**New List**

Calls the "Create Multi Segment Waveform List" dialog to enter the name of the new file.

A new new configuration table is created.

Remote command:

`[ :SOURce<hw> ] :BB:ARbitrary:WSEgment:CONFigure:SElect` on page 552

**Define Sequencing List**

Open a dialog box for configuring of the play lists (see "Multi Segment Waveform Sequencing" on page 337).

Remote command:

n.a.

**Create**

Creates a new multi segment waveform using the current table entries.

This multi segment waveform is saved with the file name specified in "Output File". As with normal waveforms, the file extension is "\*.wv".

Depending on the configuration of the multi segment waveform, calculation may take some time. A panel with a progress bar and an "Abort" button appears during creating of the multi segment waveform.

In remote control the configuration file to be used for the creation of the multi segment waveform is defined with the command: `[ :SOURce<hw> ] :BB:ARbitrary:WSEgment:CREate` or `[ :SOURce<hw> ] :BB:ARbitrary:WSEgment:CLOad`.

The file name of the waveform file is always determined with the command `[ :SOURce<hw> ] :BB:ARbitrary:WSEgment:CONFigure:OFILe`

Remote command:

`[ :SOURce<hw> ] :BB:ARbitrary:WSEgment:CREate` on page 553

**Create and Load**

Creates a new multi segment waveform using the current table entries.

This multi segment waveform is saved with the file name specified in "Output File". As with normal waveforms, the file extension is \*.wv.

Depending on the configuration of the multi segment waveform, calculation may take some time.

Following this the "Create Multi Segment Waveform File" submenu is closed and the new multi segment waveform is loaded.

In remote control the configuration file to be used for the creation of the multi segment waveform is defined with the command: `[ :SOURce<hw> ] :BB:ARbitrary:WSEgment:CREate` or `[ :SOURce<hw> ] :BB:ARbitrary:WSEgment:CLOad`.

The file name of the waveform file is always determined with the command `[ :SOURce<hw> ] :BB:ARbitrary:WSEgment:CONFigure:OFILe`

Remote command:

`[ :SOURce<hw> ] :BB:ARbitrary:WSEgment:CLOad` on page 546



## Multi Segment Waveform Sequencing

The settings provided in the "Multi Segment Waveform Sequencing" dialog can be adjusted to create a "play list", i.e. to define the sequence in which the waveform file segments are processed and how many times each of them is repeated. The configured play list is displayed in form of a "Sequencing Graphic".



All segments in a "play list" must have the same clock rate.

In the "ARB" main dialog or in the "ARB Trigger/Marker/Clock" dialog, set the "Next Segment Mode" to "Sequencer" to activate the configured "play list".

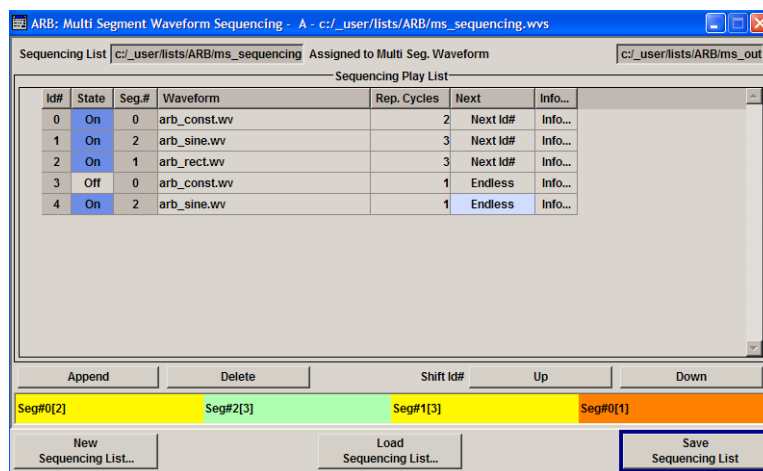

### Sequencing List

Displays the name of the selected sequencing list file, i.e. the file with the "play list" settings.

The sequencing list file has an extension \*.wvs and is automatically assigned to but independent from the multi segment file. By default, both files have the same name and are located in the same file directory. More than one sequencing list files can be created per multi segment waveform file.

The sequencing list file carries information only about the segment number, the corresponding wavefile names are retrieved from the assigned multi segment waveform file, i.e. the same sequencing list file can be reused for different multi segment waveform files with the same number of segments.

Changes and re-calculations of a multi segment waveform file cause a re-check whether the assigned sequencing list files are still valid. A message is displayed to inform about necessary corrections in the "play list".

Remote command:  
n.a.

### Assigned to Multi Seg. Waveform

Displays the name of the multi segment waveform file the current sequencing list file is assigned to.

Remote command:  
n.a.

**Sequencing Play List**

The "Sequencing Play List" table is used to define the sequence in which the waveform file segments are processed and how many times each of them is repeated.

**Id# ← Sequencing Play List**

Indication of the row number.

n.a.

**State ← Sequencing Play List**

Enables/disables the selected row. Only active segments are processed.

n.a.

**Segment# ← Sequencing Play List**

Indication of segment index.

The sequencing list file carries information only about the segment index, the corresponding wavefile names are retrieved from the assigned multi segment waveform file.

n.a.

**Waveform ← Sequencing Play List**

Indication of the waveform file name of the segment. The file name is retrieved from the assigned multi segment waveform file.

Available for selection are only waveform files from the pool of segments of the selected multi segment waveform file.

n.a.

**Repetition Cycles ← Sequencing Play List**

Sets the number of times the selected segment is cyclically repeated before the next segment in the sequence is processed.

n.a.

**Next ← Sequencing Play List**

Determines the action after completing the current one, like for instance which segment is processed after the processing of the current one is finished.

"Next Id#" The next active segment in the play list is processed.

"Blank" After the processing of the current segment is completed, the signal output is stopped until a signal restart like a retrigger signal is received.

A restart signal causes a complete restart of the sequencing play list.

"Endless" The current segment is re-played until a signal restart like a retrigger signal is received and the complete sequencing play list is restarted. Only active segments are considered.

"Goto Id#" Determines the row number of the segment to be processed next. This feature is currently limited for the first 32 rows.

Remote command:

n.a.

**Info ← Sequencing Play List**

Opens a dialog with detailed information about the currently selected waveform.

See also "[Waveform Info](#)" on page 305.

Remote command:

n.a.

**Append**

Inserts a new row at the end of the sequencing play list table.

Remote command:

[\[:SOURce<hw>\]:BB:ARbitrary:WSEgment:SEquence:SElect](#) on page 555

[\[:SOURce<hw>\]:BB:ARbitrary:WSEgment:SEquence:APPend](#) on page 555

**Delete**

Deletes the selected row.

Remote command:

n.a.

**Shift Id# Up/Down**

Shifts the selected row up and down.

Remote command:

n.a.

**Sequencing Graphic**

Displays the play list graph according to the current configuration.

The graph shows the segment sequence, the segment number and the number of times, the segment is repeated; considered are only the active segments.

Remote command:

n.a.

**New Sequencing List**

Opens the "Select Sequencing List" dialog to enter the name of the new file.

Remote command:

n.a.

**Load Sequencing List**

Opens the "Select Sequencing List" dialog to select an existing play list file.

Remote command:

n.a.

**Save Sequencing List**

Saves the current entries of the table in a play list file.

The default file name of the play list file is the same as the multi segment waveform file name, but it can be changed.

Play list files have the file extension \*.wvs.

Remote command:

n.a.

### Typical Applications for Multi Segment Waveforms

This section gives examples of the typical applications for multi segment waveforms.

#### High Speed Switchovers

To test DUTs/chips using different test signals at high throughput requires extremely fast switchovers (for instance when testing ATE devices during manufacture). The following settings enable switching times of approx. 5 us and the test signals are scrolled through with the aid of an external trigger signal:

1. "Trigger Mode" = "Auto"
2. "Trigger Source" = "External Trigger"
3. If the waveforms have different sample rates:  
"Clock Mode" = "Highest" or "User" (when creating the waveform in the Multi Segment Editor)

#### Flexible Dynamic Switchovers

When testing DUTs using different test signals, it may be necessary to switch dynamically and flexibly between any of the test signals, for instance depending on the outcome of the previous test. When using remote control via an external computer, the following settings enable switching times of approx. 20 ms for segments with the same sample rate and approx. 200 ms for segments with different sample rates:

1. "Extended Trigger Mode" = "Next Segment"
2. "Trigger Mode" = "Auto"
3. "Trigger Source" = "Internal"

#### Flexible Dynamic Switchovers without Signal Interruptions

Testing receivers requires a continuous output of different test signals without interrupting the signal. The test signals then produce a complex total signal with no signal gaps on switchover. Control procedures can use a simulated back channel of the receiver (trigger line or remote control).

Switching times depend on the length of the segment currently being output, since switchover to the next segment does not take place until the current segment comes to an end.

1. "Extended Trigger Mode" = "Next Segment Seamless"
2. "Trigger Mode" = "Auto"
3. "Trigger Source" = "Internal or External"  
If the waveforms have different sample rates:
4. "Clock Mode" = "Highest" or "User" (when creating the waveform in the Multi Segment Editor)

#### 5.7.4.4 Multi Carrier Waveforms

Multi carrier waveforms consisting of up to 512 carriers modulated by user-selectable baseband signals can be created in order to simulate complex multi carrier scenarios with different baseband signals (e.g. CDMA2000 or 3GPP FDD).

The carriers are equally spaced and centered toward the RF frequency or baseband DC line, respectively. The carrier spacing is adjustable within the total available baseband bandwidth of 80 MHz. Each carrier can be separately defined in terms of power, phase and modulated input signal. Optionally, crest factor optimization can be applied.

Thus, multi carrier waveforms can be very easily configured as broadband test signals and used for such purposes as transmitter or receiver tests. Even complex multi carrier scenarios composed of signals from different digital standards can be created and used for these tests.

##### Example for the creation of a multi carrier waveform file

1. Configure general settings
2. Configure carrier table
3. Enter file name of multi carrier waveform ("Output File")
4. Save and load multi carrier waveform ("Create" or "Create and Load")

##### User Interface

To access the "Multi Carrier" dialog, select "Baseband > ARB > Multi Carrier...".

The menu can be used to create a multi carrier waveform and save it under its own name. As with normal waveforms, the file extension is \*.wv. Information on clock rate, number of samples and creation day is displayed in the File menu when a waveform is loaded.

The "Multi Carrier" dialog is divided into the following sections.

The upper part of the menu is used for calling the default settings and saving and recalling the submenu settings.

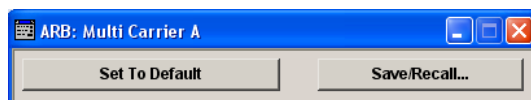

The General Settings section is used to configure the main multi carrier waveform.

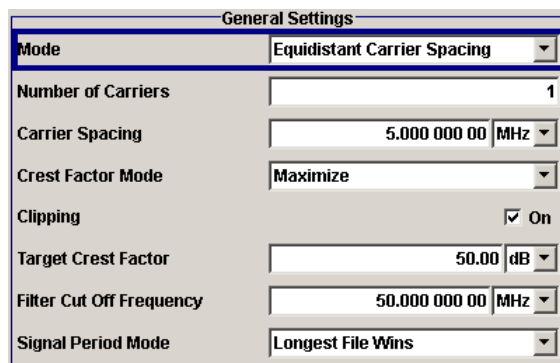

The buttons in the middle part of the menu open submenus for defining the carrier table. The carrier settings can be checked in the graphical "Carrier Graph" submenu.



The "Output Settings" section indicates the name, the size and the clock rate of the multi carrier waveform (after calculation).

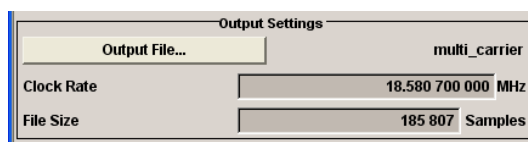

The buttons in the lower part of the menu activate creation and optionally loading of multi carrier waveform files into the main ARB menu.



### Default Settings and State

The upper part of the dialog is used for calling the default settings and saving and recalling existing ARB multi carrier submenu settings.

### Set to Default

Calls default settings. The values are shown in the following table.

Parameter	Value
Number of Carriers	1
Carrier Spacing	0 MHz
Crest Factor Mode	Off
Signal Period Mode	Longest file wins

Remote command:

[\[:SOURce<hw>\]:BB:ARbitrary:MCARrier:PRESet](#) on page 536

### Save/Recall Frame

Calls the "Save/Recall" menu.

From the "Save/Recall" menu the "File Select" windows for saving and recalling the configurations of the ARB "Multi Carrier" submenu and the "File Manager" can be called.



Multi Carrier configurations are stored as files with the predefined file extension \*.arb\_multcarr. The file name and the directory they are stored in are user-definable.

The complete settings in the Multi Carrier menu are saved and recalled.

#### "Recall Multi Carrier Settings"

Opens the "File Select" window for loading a saved Multi Carrier configuration.

The configuration of the selected (highlighted) file is loaded by pressing the "Select" button.

#### "Save Multi Carrier Settings"

Opens the "File Select" window for saving the current Multi Carrier signal configuration.

The name of the file is specified in the "File name" entry field, the directory selected in the "Save Into" field. The file is saved by pressing the "Save" button.

The "Fast Save" checkbox determines whether the instrument performs an absolute or a differential storing of the settings. Enable this function to accelerate the saving process by saving only the settings with values different to the default ones. "Fast Save" is not affected by the "Preset" function.

#### "File Manager"

Calls the "File Manager".  
The "File Manager" is used to copy, delete, and rename files and to create new directories.

#### Remote command:

[\[:SOURce<hw>\]:BB:ARbitrary:MCARrier:SETTing:CATalog?](#) on page 537

[\[:SOURce<hw>\]:BB:ARbitrary:MCARrier:SETTing:LOAD](#) on page 537

[\[:SOURce<hw>\]:BB:ARbitrary:MCARrier:SETTing:STORe:FAST](#) on page 538

[\[:SOURce<hw>\]:BB:ARbitrary:MCARrier:SETTing:STORe](#) on page 537

## General Settings

The "General Settings" section is used to configure the Multi Carrier signal.

### Mode

Selects the carrier frequency mode.

#### "Equidistant Carrier Spacing"

Sets an equidistant carrier spacing. The carrier frequency in the carrier table is not configurable.

#### "Arbitrary Carrier Frequency"

Enables you to specify the carrier frequency in the carrier table. Carrier spacing is irrelevant.

Remote command:

`[ :SOURce<hw> ] :BB:ARbitrary:MCARrier:CARRier:MODE` on page 526

### Number of Carriers

Sets the number of carriers for the multi carrier waveform.

By default the multi carrier table lists 1 carrier. When the number of carriers is increased, the multi carrier table is extended by adding further lines at the end of the table. If these carrier already have been defined before, the settings are preset according to the former settings. Otherwise the parameters are preset with the default values.

Remote command:

`[ :SOURce<hw> ] :BB:ARbitrary:MCARrier:CARRier:COUNT` on page 525

### Carrier Spacing

Sets the frequency spacing between adjacent carriers of the multi carrier waveform.

The carriers are arranged symmetrically around the RF carrier and the maximum carrier spacing is limited to:

*"Carrier Spacing" = Total Baseband Bandwidth / ("Number of Carriers" - 1).*

The total baseband bandwidth is 80 MHz.

**Note:** In order to avoid wrap-around problems, the effective "Carrier Spacing" might be slightly modified.

The "Carrier Spacing" is rounded in that way that the carrier closest to the baseband DC line shows no phase jump assuming that the carrier is unmodulated.

- For odd number of carriers:  
RoundedCarrierSpacing=1/OutputSignalDuration\* round(CarrierSpacing \* OutputSignalDuration);
- For even number of carriers:  
RoundedCarrierSpacing=2/OutputSignalDuration\*round(0.5 \*CarrierSpacing \* OutputSignalDuration).

Remote command:

`[ :SOURce<hw> ] :BB:ARbitrary:MCARrier:CARRier:SPACing` on page 526

### Crest Factor Mode

Selects the mode for optimizing the crest factor by calculating the carrier phases.

The crest factor represents the ratio of the peak voltage value to the rms voltage value. The higher the crest factor and resulting dynamics of a signal, the greater the requirement for a power amplifier fed by the signal to be linear.

The following modes are available:

- |            |  |
|------------|--|
| "Off"      | There is no automatic setting for minimizing or maximizing the crest factor. The "Phase" setting as defined in the carrier table is in use.    |
| "Minimize" | The crest factor is minimized by internally calculating optimized carrier phases. The Phase setting displayed in the carrier table is invalid. |
| "Maximize" | The crest factor is maximized by internally calculating optimized carrier phases. The Phase setting displayed in the carrier table is invalid. |

Remote command:

`[ :SOURce<hw> ] :BB:ARbitrary:MCARrier:CFACTOR:MODE` on page 529



### Clipping

Switches baseband clipping on and off.

Clipping reduces the peak power of the resulting multi carrier signal according to the input parameter "Target Crest Factor".

The resulting clipped peak power is defined by sum of the the RMS level of the unclipped multi carrier signal and the input parameter "Target Crest Factor". Note that clipping reduces also the RMS level. Hence the resulting crest factor of the clipped signal is slightly above the "Target Crest Factor". In order to get the unclipped parts of the clipped multicarrier signal matched with the unclipped multicarrier signal, the RF output power should be reduced by the difference between resulting crest factor and "Target Crest Factor".

Remote command:

`[ :SOURce<hw> ] :BB:ARbitrary:MCARrier:CLIPping[:STATe]` on page 530

### Target Crest Factor

Sets the value of the desired crest factor, if baseband clipping is enabled.

A "Target Crest Factor" above the crest factor of the unclipped multicarrier signal has no effect.

Remote command:

`[ :SOURce<hw> ] :BB:ARbitrary:MCARrier:CLIPping:CFACTOR` on page 529

### Filter Cut Off Frequency

Sets the cut off frequency of the final lowpass filter, if baseband clipping is enabled.

When the cut off frequency is set as half of the output sample rate, a final lowpass filter improves the spectrum of the clipped multicarrier signal, but may also increase the resulting crest factor.

Remote command:

`[ :SOURce<hw> ] :BB:ARbitrary:MCARrier:CLIPping:CUTOFF` on page 530

### Signal Period Mode

Selects the mode for calculating the resulting signal period of the multi carrier waveform. The carrier table provides an information button to obtain sample rate and file length data of each carrier.

The resulting period is always calculated for all carriers in the carrier table irrespective of their state (On/Off).

**Note:** Wrap-around and timing problems may occur when I/Q signals of different length are used. Thus, demodulation of a carrier may be difficult or even impossible. It is therefore recommended to consider the timing already when creating the input I/Q files or to adjust the signal duration to the carrier which is subsequently demodulated (in this case, the other carriers are for interfering the signal only). These problems do not arise with signals of the same standard (e.g. 3GPP).

The following modes are available:

"Longest File Wins"

The resulting signal period is defined by the longest I/Q file in the carrier table. Shorter I/Q files are periodically repeated.

**"Shortest File Wins"**

The resulting signal period is defined by the shortest I/Q file in the carrier table. Only the first part of longer I/Q files is used.

**"User"**

The signal period can be set by the user in the "Signal Period" field. Shorter I/Q files are repeated periodically, and only the first part of longer I/Q files is used.

**"Least Common Multiple"**

The output file duration is the least common multiple of all input file durations.

Remote command:

`[ :SOURce<hw> ]:BB:ARbitrary:MCARrier:TIME:MODE` on page 538

**Signal Period**

Sets the signal period in Signal Duration Mode "User". Shorter I/Q files are repeated periodically, and only the first part of longer I/Q files is used.

Remote command:

`[ :SOURce<hw> ]:BB:ARbitrary:MCARrier:TIME` on page 538

**Power Reference**

Defines the way the individual carriers in a composed multi carrier signal are leveled. The difference between the provided modes is especially important if signals with different crest factors are composed together into a multi carrier signal.

**"RMS"** The individual carriers are leveled based on their RMS power and the configured "Carrier Gain".

**Example:**

A multi carrier signal is composed from two waveform files.

First carrier "Gain" = 0 dB

Second carrier "Gain" = -3 dB

In the resulting multi carrier signal, the *RMS power* of the second carrier signal will be 3 dB lower than the RMS power of the first carrier signal.

"Peak" The individual carriers are leveled based on their peak power and the configured "Carrier Gain".

**Example:**

A multi carrier signal is composed from two waveform files.

First carrier "Gain" = 0 dB

Second carrier "Gain" = -3 dB

In the resulting multi carrier signal, the *peak power* of the second carrier signal will be 3 dB lower than the peak power of the first carrier signal.

**Example: Multi carrier signal composed of waveforms with different crest factor**

A multi carrier signal is composed from two waveform files with the following characteristics:

3GPP FDD signals with the same "Sample Rate" but *different "Crest Factors"*.

"Peak" = 0 dBFS

"Carrier Gain" = 0 dB

	State	Carrier Freq [MHz]	Gain [dB]	Phase [deg]	Delay [ns]	File	Info	!!!
0	On	-5.000 000	0.00	0.00	0	e:/file1	Info...	
1	On	5.000 000	0.00	0.00	0	e:/file2	Info...	

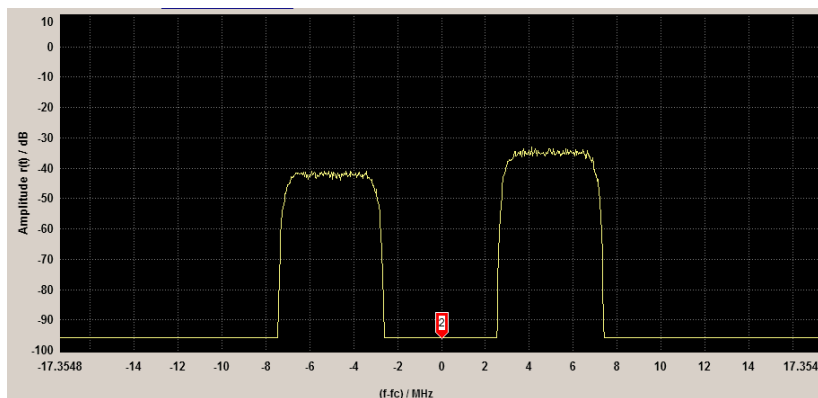

The Peak values of the carrier signals are equal, the RMS values are different.

Remote command:

`[ :SOURce<hw> ] :BB:ARbitrary:MCARrier:POWer:REference` on page 528

**Carrier Table**

Calls the table for configuring individual carriers. A selectable carrier range can be set with the aid of the optional "Carrier Table Assistant" (see "Muti Carrier Table" on page 349).

The multi carrier configuration can be checked with the aid of the "Carrier Graph".

### Carrier Graph

Calls a graphical representation of the current multi carrier configuration in the frequency domain.

The height of the bars corresponds to the chosen gain of each individual carrier. The bandwidth of the carriers signals is indicated by the width of the bars.

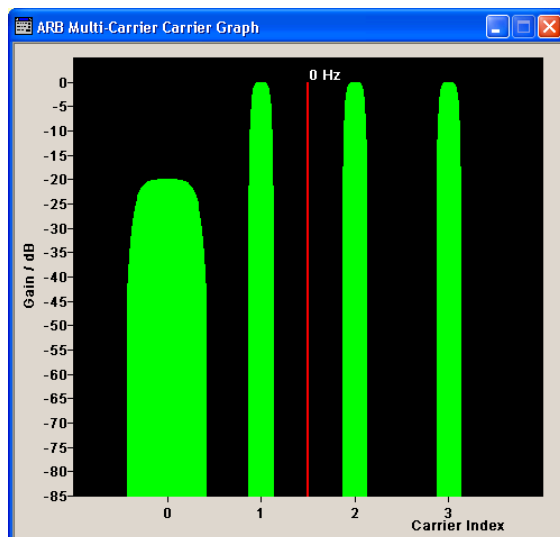

### Output Settings

The "Output Settings" section in the multi carrier main menu indicates the name, the size and the clock rate of the currently calculated multi carrier output file.

#### File

Opens the "File" menu, where the output file name of the multi carrier waveform which has to be calculated can be entered.

The multi carrier waveform is calculated and saved under this name by clicking the "Create" or "Create and Load" button.

Remote command:

`[ :SOURce<hw> ] :BB:ARbitrary:MCARrier:OFILe` on page 536

#### Clock Rate

Displays the resulting sample rate at which the multi carrier waveform is output by the arbitrary waveform generator. The output clock rate depends on the number of carriers, carrier spacing and input sample rate of the leftmost or rightmost carriers.

Remote command:

`[ :SOURce<hw> ] :BB:ARbitrary:MCARrier:CLOCK?` on page 531

#### File Size

Displays the resulting number of samples of the multi carrier waveform.

Remote command:

`[ :SOURce<hw> ] :BB:ARbitrary:MCARrier:SAMPles?` on page 536

**Create**

Creates a new multi carrier waveform defined by the multi carrier table and General Setting entries.

This multi carrier waveform is saved with the file name specified in "Output File". If no file name is specified, the File Manager opens so that the file name can be entered. As with normal waveforms, the file extension is \*.wv.

Depending on the configuration of the multi carrier waveform, calculation may take some time. A panel with a progress bar and an "Abort" button appears during the calculation process.

Remote command:

`[ :SOURce<hw> ] :BB:ARbitrary:MCARrier:CREate` on page 532

**Create and Load**

Creates a new multi carrier waveform defined by the multi carrier table and General Setting entries and loads it subsequently in the "ARB" main menu.

This multi carrier waveform is saved with the file name specified in "Output File". If no file name is specified, the File Manager opens so that the file name can be entered. As with normal waveforms, the file extension is \*.wv.

Depending on the configuration of the multi carrier waveform, calculation may take some time. A panel with a progress bar and an "Abort" button appears during the calculation process.

Remote command:

`[ :SOURce<hw> ] :BB:ARbitrary:MCARrier:CLoad` on page 531

**Muti Carrier Table**

The "Multi Carrier Table" manu is oped by means of the "Carrier Table" button in the middle part of the Multi Carrier Waveforms menu. The carrier settings can be checked in the graphical "Carrier Graph" submenu.

The "Carrier Table Assistant" section can be used to set a selectable carrier range. This section serves as a optional mean to quickly set up a multi carrier scenario within a specified carrier range.

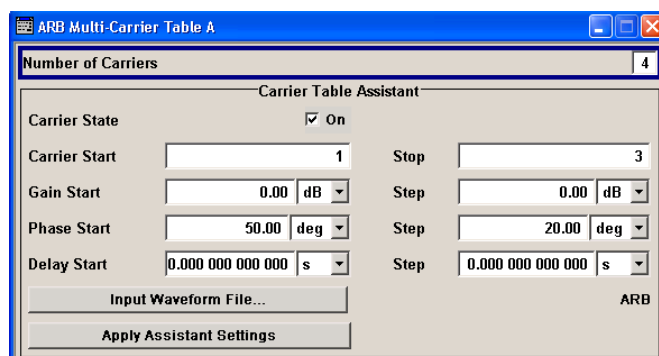

	State	Carrier Freq [MHz]	Gain [dB]	Phase [deg]	Delay [ns]	File	Info	!!!
0	On	-7.500 000	0.00	0.00		0 \Lists\Arb\ArbMccwDummy	Info...	
1	On	-2.500 000	0.00	0.00		0 \Lists\Arb\ArbMccwDummy	Info...	
2	On	2.500 000	0.00	0.00		0 \Lists\Arb\ArbMccwDummy	Info...	
3	Off	7.500 000	0.00	0.00		0 \Lists\Arb\ArbMccwDummy	Info...	

## Carrier Table Assistant

### Number of Carriers

Defines the number of carriers of the multi carrier waveform.

This parameter is identical to that in the "General Setting" section.

Remote command:

[\[:SOURce<hw>\]:BB:ARbitrary:MCARrier:CARRier:COUNT](#) on page 525

### Carrier State

Switches the carriers in the range "Carrier Start" to "Carrier Stop" on/off.

Remote command:

[\[:SOURce<hw>\]:BB:ARbitrary:MCARrier:EDIT:CARRier:STATE](#) on page 536

### Carrier Start

Defines the start index of the carrier range to which the assistant settings are intended to apply.

Remote command:

[\[:SOURce<hw>\]:BB:ARbitrary:MCARrier:EDIT:CARRier:START](#) on page 535

### Carrier Stop

Defines the stop index of the carrier range to which the assistant settings are intended to apply.

Remote command:

[\[:SOURce<hw>\]:BB:ARbitrary:MCARrier:EDIT:CARRier:STOP](#) on page 535

### Gain Start

Sets the gain of the carrier marked by "Carrier Start".

Remote command:

[\[:SOURce<hw>\]:BB:ARbitrary:MCARrier:EDIT:CARRier:POWER\[:START\]](#) on page 535

### Gain Step

Sets the step width that is used to increment the gain

The resulting carrier gain in the carrier table equals:

### GainStart + n\* Gain Step

where n ranges from 0 to (Carrier Stop - Carrier Start).

Remote command:

```
[ :SOURce<hw> ] :BB:ARbitrary:MCARrier:EDIT:CARRier:POWer:STEP  
on page 534
```

### Phase Start

Sets the phase of the carrier marked by "Carrier Start".

Remote command:

```
[ :SOURce<hw> ] :BB:ARbitrary:MCARrier:EDIT:CARRier:PHASE [ :START ]  
on page 534
```

### Phase Step

Sets the step width that is used to increment the phase.

The resulting phase in the carrier table equals:

#### PhaseStart + n\* PhaseStep

where n ranges from 0 to (Carrier Stop – Carrier Start)

Remote command:

```
[ :SOURce<hw> ] :BB:ARbitrary:MCARrier:EDIT:CARRier:POWer:STEP  
on page 534
```

### Delay Start

Sets the delay of the carrier marked by "Carrier Start".

Remote command:

```
[ :SOURce<hw> ] :BB:ARbitrary:MCARrier:EDIT:CARRier:DELAy [ :START ]  
on page 533
```

### Delay Step

Sets the step width that is used to increment the delay

The resulting delay in the carrier table equals:

#### DelayStart + n\* DelayStep

where n ranges from 0 to (Carrier Stop – Carrier Start).

Remote command:

```
[ :SOURce<hw> ] :BB:ARbitrary:MCARrier:EDIT:CARRier:DELAy:STEP  
on page 532
```

### Input Waveform File

Calls the "File" menu for selecting the inputfile with the I/Q signal to be modulated onto all carriers of the selected carrier range.

Remote command:

```
[ :SOURce<hw> ] :BB:ARbitrary:MCARrier:EDIT:CARRier:FILE on page 533
```

### Apply Assistant Settings

Transfer the assistant settings to the carrier table.

Remote command:

```
[ :SOURce<hw> ] :BB:ARbitrary:MCARrier:EDIT:CARRier:EXECute  
on page 533
```

**Carrier Table**

The table displays the settings of all available carriers. Previously applied assistant settings can be further refined. The number of lines corresponds to the number of carriers.

**Note:** The phase/deg settings are only valid if optimization of the crest factor is disabled ("Crest Factor Mode" = Off).

	State	Carrier Freq [MHz]	Gain [dB]	Phase [deg]	Delay [ns]	File	Info	!!!
0	On	-7.500 000	0.00	0.00		0 \Lists\Arb\ArbMccwDummy	Info...	
1	On	-2.500 000	0.00	0.00		0 \Lists\Arb\ArbMccwDummy	Info...	
2	On	2.500 000	0.00	0.00		0 \Lists\Arb\ArbMccwDummy	Info...	
3	Off	7.500 000	0.00	0.00		0 \Lists\Arb\ArbMccwDummy	Info...	

**No ← Carrier Table**

Indicates the carrier index ranging from 0 to (number of carriers -1).

Individual carriers can be set using the remote control commands by specifying the index in the parameter CARR.

**State ← Carrier Table**

Switches On/Off a carrier.

Remote command:

[\[:SOURCE<hw>\]:BB:ARbitrary:MCARrier:CARRier<ch>:STATE](#) on page 529

**Carrier Freq [MHz] ← Carrier Table**

Sets the carrier frequency.

**Note:** The carrier frequency can only be set in "Arbitrary Carrier frequency" mode. For "Equidistant Carrier Spacing", the carrier spacing is determined automatically.

Remote command:

[\[:SOURCE<hw>\]:BB:ARbitrary:MCARrier:CARRier<ch>:FREQuency](#)  
on page 527

**Gain ← Carrier Table**

Sets the gain of a carrier.

Remote command:

[\[:SOURCE<hw>\]:BB:ARbitrary:MCARrier:CARRier<ch>:POWER](#) on page 528

**Phase ← Carrier Table**

Sets the starting phase of a carrier.

Remote command:

[\[:SOURCE<hw>\]:BB:ARbitrary:MCARrier:CARRier<ch>:PHASE](#) on page 528

**Delay ← Carrier Table**

Sets the starting delay of a carrier.

Remote command:

[\[:SOURCE<hw>\]:BB:ARbitrary:MCARrier:CARRier<ch>:DELay](#) on page 527



**File ← Carrier Table**

Calls the "File" menu for selecting the input file with the I/Q signal to be modulated onto the carrier.

Remote command:

`[ :SOURCE<hw> ] :BB:ARbitrary:MCARrier:CARRIER<ch>:FILE` on page 527

**Info ← Carrier Table**

Indicates the sample rate, number of I/Q value pairs (number of samples), and the resulting signal period of the selected I/Q input file.

Remote command:

n.a.

**!!! ← Carrier Table**

Indicates an occurred conflict by a means of a red LED. A conflict arises when the carriers overlap.

**Example:**

A conflict is indicated both in the table, as well as in the graph, as shown in the following figures:

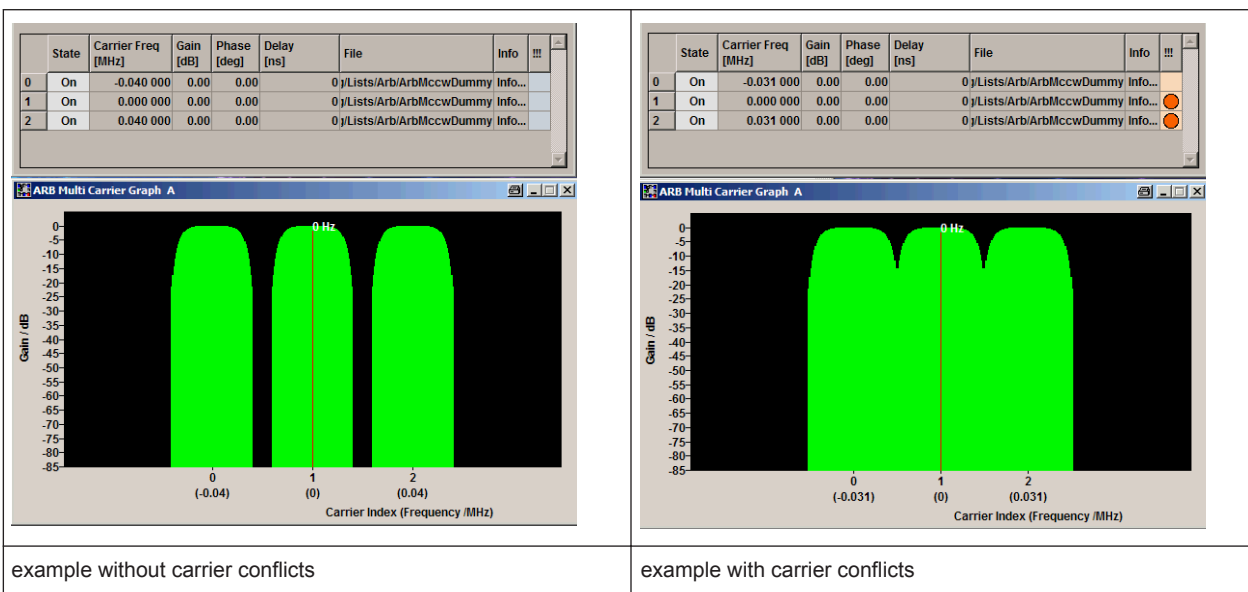

Remote command:

`[ :SOURCE<hw> ] :BB:ARbitrary:MCARrier:CARRIER<ch>:CONFLICT?` on page 527

**Typical Applications for Multi Carrier Waveforms**

High Power Amplifiers of multi carrier base stations face increased requirements in terms of linearity and acceptable intermodulation performance.

A standard transmitter test might be quickly setup by the following instructions:

1. Load a standardized 3GPP downlink test model, e.g. "Test Model 1\_16" and set State to "ON".
2. Create a 3GPP Testmodel ARB file by activating "Generate Waveform File".
3. Setup a multi carrier scenario with 4 carriers and a carrier spacing of 5 MHz.
4. Apply the input file containing the previously generated 3GPP testmodel to all 4 carriers.

### 5.7.5 Multi Carrier Continuous Wave

The R&S AMU can generate a Multi Carrier CW signal with user-definable offset from carrier, based on a selection of up to 8192 unmodulated carriers. Each carrier can be separately set and switched on, or multiple carriers can be jointly configured. Automatic start phase setting is provided in order to minimize the crest factor.

Multi Carrier CW signals can be very easily configured as broadband test signals and used for such purposes as receiver tests.

To access the dialog for setting a Multi Carrier CW signal, select "Baseband > Multi Carrier CW" or use MENU key under "Baseband".



#### 5.7.5.1 Multi Carrier CW User Interface

The "Multi Carrier CW" dialog is divided into the following sections.

The upper part of the menu is used for powering up the Multi Carrier CW and calling the default settings.

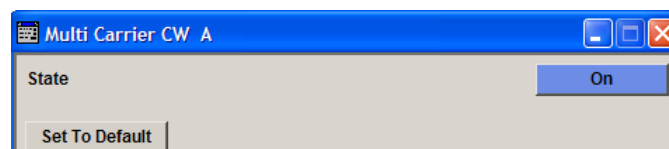

The "Carrier Setup" section is used to configure the Multi Carrier CW signal.

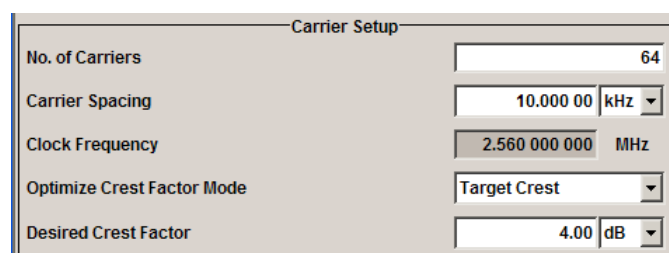

The "Table Setup Assistant" section can be used to set a selectable carrier range.

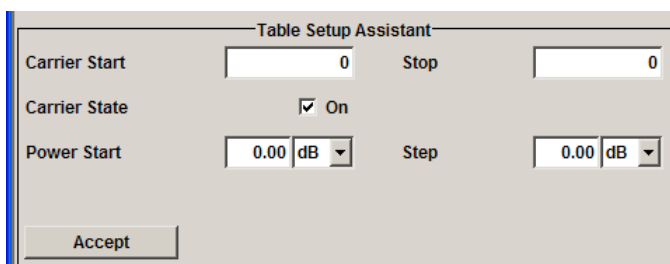

The buttons in the lower part of the menu open dialogs for defining carrier tables and for configuring markers, triggers and clocks.

The carrier settings can be visualized in the graphical "Carrier Graph" dialog.

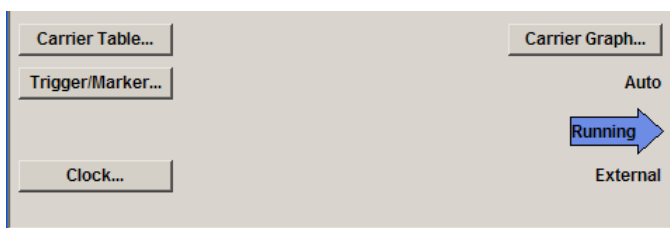

### General Settings for Multi Carrier CW

The upper part of the menu is used for powering up the Multi Carrier CW signal and calling the default settings.

#### State

Enables/disables the Multi Carrier CW.

Switching on this standard turns off all the other digital standards and digital modulation modes.

In case of two-path instruments, this affects the same path.

Since Multi Carrier CW signals are computed in arbitrary waveform mode, changes to the settings of individual carriers are not adopted until the Accept button is pressed. This applies to the settings in the "Table Setup Assistant" section and the "Carrier Table" dialog.

Remote command:

[ :SOURce<hw> ] :BB:MCCW:STATe on page 601

#### Set to Default

Calls default settings. The values are shown in the following table.

Parameter	Value
State	Not affected by "Set to Default"
<b>Carrier Setup</b>	
Number of Carriers	64
Carrier Spacing	10 kHz
Optimize Crest Factor	Chirp

Parameter	Value
Desired Crest Factor	3 dB
<b>Trigger</b>	
Mode	Auto
Source	Internal
Ext. Delay	0
Ext. Inhibit	0
<b>Marker</b>	
Channel 1...4	Restart
<b>Clock</b>	
Source	Internal
<b>Multi Channel Setup</b>	
Start Carrier	0
Stop Carrier	0
State	ON
Power	0 dB
Power Step	0 dB
Initial Phase	0°
Phase Step	0°
<b>Channel Setup</b>	
State	ON
Phase	0°
Power	0 dB

Remote command:

[ :SOURce<hw> ] :BB:MCCW:PRESet on page 601

### Carrier Setup

The "Carrier Setup" section is used to configure the Multi Carrier CW.

#### Number of Carriers

Sets the number of carriers for the Multi Carrier CW signal.

By default the multi carrier table already lists 64 carriers that are preset to the settings State = ON, Power = 0 dB, Phase = 0°.

When entering fewer carriers than the table contains, the approach is generally to delete the superfluous entries from the table, and when entering more carriers than the table contains the missing entries are usually added at the end of the table.

Remote command:

[ :SOURce<hw> ] :BB:MCCW:CARRier:COUNT on page 602

### Carrier Spacing

Sets the spacing between carriers for the Multi Carrier CW signal.

The carriers are arranged symmetrically around the HF carrier.

The total bandwidth is calculated as follow:

Total Bandwidth = ("Number of Carriers" - 1) \* "Carrier Spacing"

The result must not exceed the system bandwidth of the instrument (see data sheet).

Remote command:

[ :SOURce<hw> ] :BB:MCCW:CARRier:SPACing on page 605

### Clock Frequency

Displays the clock rate at which the multi carrier signal is output by the arbitrary waveform generator. The output clock rate depends on the number of carriers and the selected carrier offset.

The value indicates the resolution during the marker generation.

Remote command:

[ :SOURce<hw> ] :BB:MCCW:CLOCK? on page 607

### Optimize Crest Factor Mode

Selects the mode for automatically minimizing the crest factor.

The carrier start phases are automatically set to this.

The crest factor represents the ratio of the peak voltage value to the rms voltage value. The higher the crest factor and resulting dynamics of a signal, the greater the requirement for a power amplifier fed by the signal to be linear.

A very high crest factor arises when the carriers have an identical start phase, since the carriers are periodically superposed and very high peak voltages occur in relation to the rms voltage values.

Methods of reducing the crest factor differ with regard to both the optimization achievable and the time required for computation.

"Off"	There are no automatic settings for minimizing the crest factor. The "Phase" setting has an effect.
"Chirp"	Very rapid crest factor optimization regardless of the number of carriers. A minimal crest factor of < 3 dB is only obtained for multi carrier signals in which all carriers are switched on and the power of the carriers is identical. In a configuration which differs from this, the achievable crest factor is worse.
"Target Crest"	Optimization of the crest factor to a desired value for all carrier configurations. The optimization time depends on the number of carriers and the desired crest factor. Computation time increases only when the number of carriers exceeds 256 and the crest factor is below 4 dB. The desired value can be entered in "Desired Crest Factor".  <b>Note:</b> Optimization can be cancelled at any time, and the current value being displayed at that moment is then used.

Remote command:

[ :SOURce<hw> ] :BB:MCCW:CFACTOR:MODE on page 606

### Desired Crest Factor

Enters the desired crest factor.

This is only possible when the optimization "Target Crest" has been selected.

Remote command:

[ :SOURce<hw> ] :BB:MCCW:CFACTOR on page 606

### Table Setup Assistant

The "Table Setup Assistant" section can be used to set a selectable carrier range. The carrier table can be edited in the "Carrier Table" dialog.

### Carrier Start

Defines the start index of the carrier range to which the following settings are intended to apply.

Remote command:

[ :SOURce<hw> ] :BB:MCCW:EDIT:CARRIER:START on page 610

### Carrier Stop

Defines the stop index of the carrier range to which the following settings are intended to apply.

Remote command:

[ :SOURce<hw> ] :BB:MCCW:EDIT:CARRIER:STOP on page 610

### Carrier State

Switches the carriers in the carrier range on/off.

Remote command:

[ :SOURce<hw> ] :BB:MCCW:EDIT:CARRIER:STATE on page 610

### Power Start

Sets the power of the starting carrier.

Remote command:

[ :SOURce<hw> ] :BB:MCCW:EDIT:CARRIER:POWER[:START] on page 609

### Power Step

Sets the width of the step with which the power will be changed from carrier to carrier.

The carrier power that is set with **Power + n\* Power Step** must be within the valid value range -80 dB to 0 dB.

Remote command:

[ :SOURce<hw> ] :BB:MCCW:EDIT:CARRIER:POWER:STEP on page 609

### Phase Start

Sets the phase of the starting carrier. This setting is only available for "Optimize Crest Factor Mode" = Off.

Remote command:

`[ :SOURce<hw> ] :BB:MCCW:EDIT:CARRier:PHASe [ :START ]` on page 608

### Phase Step

Sets the width of the step with which the phase will be changed from carrier to carrier.

The phase that is set with **Phase + n\* Phase Step** must be within the valid value range 0° to 360°.

This setting is only available for "Optimize Crest Factor Mode" = Off.

Remote command:

`[ :SOURce<hw> ] :BB:MCCW:EDIT:CARRier:PHASe:STEP` on page 608

### Accept

Adopts the carrier range setting into the table ("Carrier Table").

Remote command:

`[ :SOURce<hw> ] :BB:MCCW:EDIT:CARRier:EXECute` on page 607

### Carrier Table and Carrier Graph

The lower part of the menu is used to open submenus for configuring carrier tables and for setting triggers, markers and clocks.

### Carrier Table

Calls the table for configuring individual carriers. This configuration can be checked with the aid of the "Carrier Graph".

	State	Power / dB	Phase / deg
0	On	0.00	0.00
1	On	0.00	0.00
2	On	0.00	0.00
3	Off	0.00	0.00
4	Off	0.00	0.00
5	Off	0.00	0.00
6	On	0.00	0.00
7	On	0.00	0.00
8	On	0.00	0.00

Accept

The table displays the settings of all available carriers. Carriers in the On state are highlighted. All carrier parameters can be edited in the table.

The Multi Carrier CW signal is only computed when the "Accept" button is pressed. Whenever the table contains settings that have not yet been adopted with the "Accept" button, the background is yellow.

**Note:** The phase/deg settings are only valid if optimization of the crest factor is disabled ("Optimize Crest Factor" = Off).

- "No." This is the carrier index.
- "State" Switch a carrier on/off
- "Power" Sets the power of a carrier.

"Phase" Sets the starting phase of a carrier.

"Accept" Transfer the settings in the carrier table into the instrument.

Remote command:

[ :SOURce<hw> ] :BB:MCCW:CARRier:LIST:STATe on page 604

[ :SOURce<hw> ] :BB:MCCW:CARRier:STATe on page 605

[ :SOURce<hw> ] :BB:MCCW:CARRier:LIST:POWer on page 603

[ :SOURce<hw> ] :BB:MCCW:CARRier:POWer on page 605

[ :SOURce<hw> ] :BB:MCCW:CARRier:LIST:PHASe on page 602

[ :SOURce<hw> ] :BB:MCCW:CARRier:PHASe on page 604

### Carrier Graph

Calls a graphical representation of the chosen carrier configuration.

The carriers are on the X-axis and the colored bars represent those carriers which are in the On state. Power is on the Y-axis, and the height of the bars corresponds to the chosen power of each individual carrier.

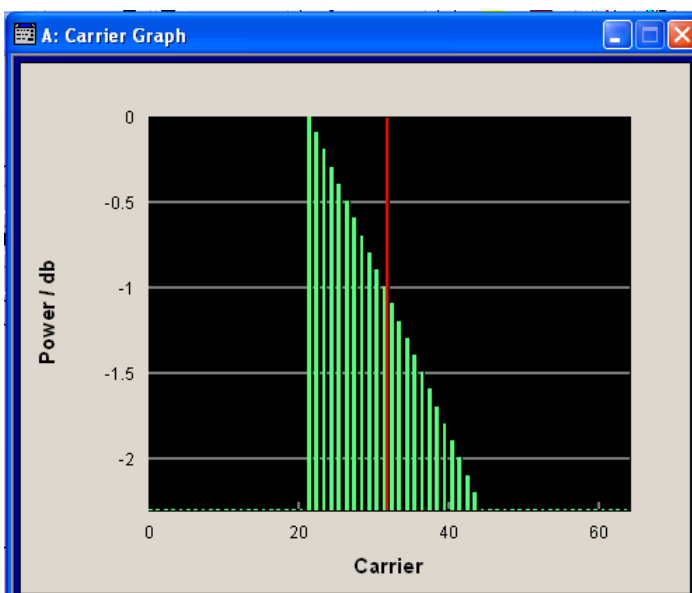

Remote command:

n.a.

### Trigger/Marker

Calls the "Trigger/Marker" dialog (see "Trigger/Marker/Clock Settings" on page 361).

This dialog is used to select the trigger source, set the time delay on an external trigger signal and configure the marker output signals.

Remote command:

n.a.

### Clock

Calls the "Clock" dialog for selecting the clock source (see "Clock Settings" on page 366).



Remote command:  
n.a.

**Trigger/Marker/Clock Settings**

To access this dialog, select "Main Menu > Trigger/Marker".

The "Trigger In" section is where the trigger for the signal is set. Various parameters will be provided for the settings, depending on which trigger source - internal or external - is selected. The current status of signal generation ("Running" or "Stopped") is indicated for all trigger modes.

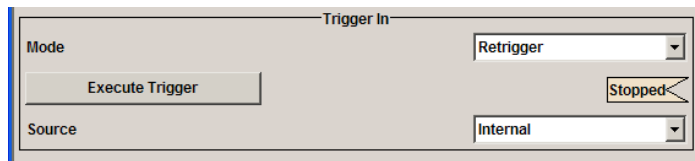

The "Marker Mode" section is where the marker signals at the MARKER output connectors are configured.

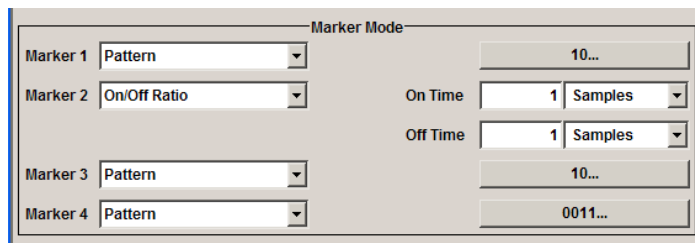

The "Marker Delay" section is where a marker signal delay can be defined, either without restriction or restricted to the dynamic section, i.e., the section in which it is possible to make settings without restarting signal and marker generation.

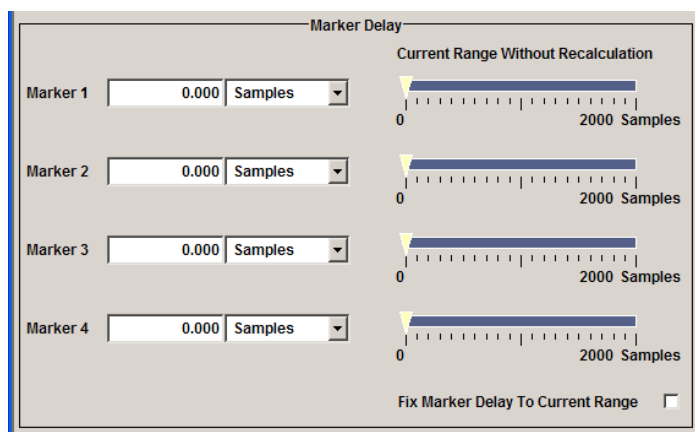

The "Clock Settings" section is where the clock source is selected and - in the case of an external source - the clock type.

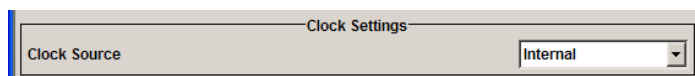

The buttons in the last section lead to submenu for general trigger, clock and mapping settings.

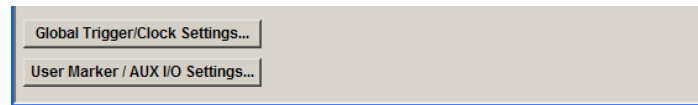

### Trigger In

The "Trigger In" section is where the trigger for the signal is set. Various parameters will be provided for the settings, depending on which trigger source - internal or external - is selected. The current status of signal generation ("Running" or "Stopped") is indicated for all trigger modes.

### Trigger Mode

Selects trigger mode.

The trigger mode determines the effect of a trigger on the signal generation.

"Auto"	The signal is generated continuously.
"Retrigger"	The signal is generated continuously. A trigger event (internal or external) causes a restart.
"Armed_Auto"	The signal is generated only when a trigger event occurs. Then the signal is generated continuously. Button "Arm" stops signal generation. A subsequent trigger event (internal with "Execute Trigger" or external) causes a restart.
"Armed_Retrigger"	The signal is generated only when a trigger event occurs. Then the signal is generated continuously. Every subsequent trigger event causes a restart. Button "Arm" stops signal generation. A subsequent trigger event (internal with "Execute Trigger" or external) causes a restart.
"Single"	The signal is generated only when a trigger event occurs. Then the signal is generated once to the length specified at "Signal Duration". Every subsequent trigger event (internal with "Execute Trigger" or external) causes a restart.

Remote command:

[\[:SOURCE<hw>\]:BB:MCCW\[:TRIGGER\]:SEQUENCE](#) on page 615

### Signal Duration

Defines the length of the signal sequence to be output in the "Single" trigger mode. The unit of the entry is defined under "Signal Duration Unit". It is then possible to output deliberately just part of the signal, an exact sequence of the signal, or a defined number of repetitions of the signal.

Remote command:

[\[:SOURCE<hw>\]:BB:MCCW:TRIGGER:SLNGTH](#) on page 613

### Running/Stopped

Displays the status of signal generation for all trigger modes. This display appears only when signal generation is enabled ("State" On).

"Running"	The modulation signal is generated; a trigger was (internally or externally) initiated in triggered mode. If "Armed_Auto" and "Armed_Retrigger" have been selected, generation of signals can be stopped with the "Arm" button. A new trigger (internally with "Execute Trigger" or externally) causes a restart.
"Stopped"	The signal is not generated, and the instrument waits for a trigger event (internal or external).

Remote command:

[\[:SOURce<hw>\]:BB:MCCW:TRIGger:RMODE?](#) on page 613

### Arm

Stops signal generation. This button appears only with "Running" signal generation in the "Armed\_Auto" and "Armed\_Retrigger" trigger modes.

Signal generation can be restarted by a new trigger (internally with "Execute Trigger" or externally).

Remote command:

[\[:SOURce<hw>\]:BB:MCCW:TRIGger:ARM:EXECute](#) on page 611

### Execute Trigger

Executes trigger manually. A manual trigger can be executed only when an internal trigger source and a trigger mode other than "Auto" have been selected.

Remote command:

[\[:SOURce<hw>\]:BB:MCCW:TRIGger:EXECute](#) on page 611

### Trigger Source

Selects trigger source. This setting is effective only when a trigger mode other than "Auto" has been selected.

"Internal"	The trigger event is executed by "Execute Trigger".
"Internal (two-path instruments only)"	
"Internal (Baseband A/B)"	The trigger event is executed by the trigger signal from the second path
"External"	The trigger event is executed with the aid of the active edge of an external trigger signal. The trigger signal is supplied via the TRIGGER 1/2 connector. The polarity, the trigger threshold and the input impedance of the trigger input can be set in the "Global Trigger/Clock Settings" dialog.

Remote command:

[\[:SOURce<hw>\]:BB:MCCW:TRIGger:SOURce](#) on page 614

### Sync. Output to External Trigger

(enabled for Trigger Source External)

Enables/disables output of the signal synchronous to the external trigger event.

"On"

Corresponds to the default state of this parameter.

The signal calculation starts simultaneously with the external trigger event but because of the instrument's processing time the first samples are cut off and no signal is outputted. After elapsing of the internal processing time, the output signal is synchronous to the trigger event.

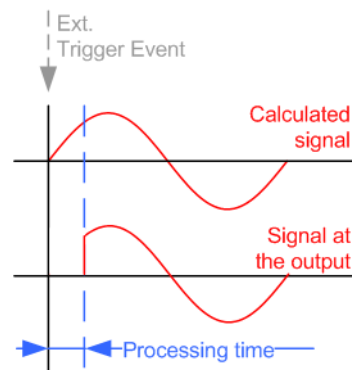

"Off"

The signal output begins after elapsing of the processing time and starts with sample 0, i.e. the complete signal is outputted.

This mode is recommended for triggering of short signal sequences with signal duration comparable with the processing time of the instrument.

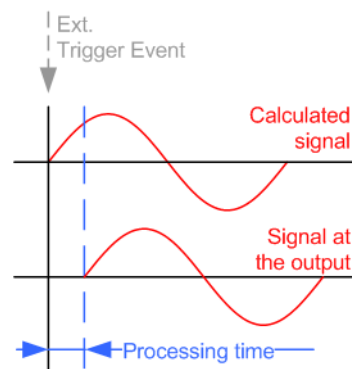

Remote command:

`[ :SOURce<hw> ] :BB:MCCW:TRIGger:EXTernal:SYNChronize:OUTPut`  
on page 611

### Trigger Delay

Sets the trigger signal delay in samples on external triggering or on internal triggering via the second path.

This enables the R&S AMU to be synchronized with the device under test or other external devices.

For two-path instruments, the delay can be set separately for each of the two paths.

Remote command:

`[ :SOURce<hw> ] :BB:MCCW:TRIGger [ :EXTernal<ch> ] :DELay` on page 614  
`[ :SOURce<hw> ] :BB:MCCW:TRIGger:OBASeband:DELay` on page 612

**Trigger Inhibit**

Sets the duration for inhibiting a new trigger event subsequent to triggering. The input is to be expressed in samples.

In the "Retrigger" mode, every trigger signal causes signal generation to restart. This restart is inhibited for the specified number of samples.

This parameter is only available on external triggering or on internal triggering via the second path.

For two-path instruments, the trigger inhibit can be set separately for each of the two paths.

Remote command:

`[ :SOURce<hw> ] :BB:MCCW:TRIGger [ :EXTernal<ch> ] :INHibit` on page 614

`[ :SOURce<hw> ] :BB:MCCW:TRIGger:OBASeband:INHibit` on page 612

**Marker Mode**

Provides the settings necessary to define the marker output signal for synchronizing external instruments.

**Marker Mode**

Marker configuration for up to 4 marker channels. The settings are used to select the marker mode defining the shape and periodicity of the markers. The contents of the dialog change with the selected marker mode; the settings are self-explanatory.

All regular marker signals are described in "[Marker Modes](#)" on page 254.

"Restart"            A marker signal is generated at the start of the waveform.

Remote command:

`[ :SOURce<hw> ] :BB:MCCW:TRIGger:OUTPut<ch>:MODE` on page 618

`[ :SOURce<hw> ] :BB:MCCW:TRIGger:OUTPut<ch>:PULSe:DIVider` on page 619

`[ :SOURce<hw> ] :BB:MCCW:TRIGger:OUTPut<ch>:PULSe:FREQuency?`  
on page 619

`[ :SOURce<hw> ] :BB:MCCW:TRIGger:OUTPut<ch>:PATtern` on page 619

`[ :SOURce<hw> ] :BB:MCCW:TRIGger:OUTPut<ch>:ONTime` on page 618

`[ :SOURce<hw> ] :BB:MCCW:TRIGger:OUTPut<ch>:OFFTime` on page 618

**Marker Delay**

The delay of the signals on the MARKER outputs is set in the "Marker Delay" section.

**Marker x Delay**

Enters the delay between the marker signal at the marker outputs and the start of the frame or slot.

The input is expressed as a number of symbols. If the setting "Fix marker delay to dynamic range" is enabled, the setting range is restricted to the dynamic range. In this range the delay of the marker signals can be set without restarting the marker and signal.

Remote command:

`[ :SOURce<hw> ] :BB:MCCW:TRIGger:OUTPut<ch>:DELay` on page 616

**Current Range without Recalculation**

Displays the dynamic range within which the delay of the marker signals can be set without restarting the marker and signal.

The delay can be defined by moving the setting mark.

Remote command:

`[ :SOURce<hw> ] :BB:MCCW:TRIGger:OUTPut<ch>:DElay:MINimum?`

on page 617

`[ :SOURce<hw> ] :BB:MCCW:TRIGger:OUTPut<ch>:DElay:MAXimum?`

on page 617

**Fix marker delay to current range**

Restricts the marker delay setting range to the dynamic range. In this range the delay can be set without restarting the marker and signal.

Remote command:

`[ :SOURce<hw> ] :BB:MCCW:TRIGger:OUTPut:DElay:FIXed` on page 616

**Clock Settings**

The Clock Settings is used to set the clock source and a delay if required.

**Clock Source**

Selects the clock source.

- |            |   |
|------------|---|
| "Internal" | The internal clock reference is used to generate the symbol clock.  |
| "External" | The external clock reference is fed in as the symbol clock or multiple thereof via the CLOCK connector.<br>The polarity of the clock input can be changed with the aid of "Global Trigger/Clock Settings".<br>In the case of two-path instruments this selection applies to path A. |

Remote command:

`[ :SOURce<hw> ] :BB:MCCW:CLOCK:SOURCE` on page 621

**Clock Mode**

Enters the type of externally supplied clock.

- |                   |   |
|-------------------|---|
| "Sample"          | A sample clock is supplied via the CLOCK connector.   |
| "Multiple Sample" | A multiple of the sample clock is supplied via the CLOCK connector; the sample clock is derived internally from this. |

Remote command:

`[ :SOURce<hw> ] :BB:MCCW:CLOCK:MODE` on page 620

**Clock Multiplier**

Enters the multiplication factor for clock type "Multiple".

Remote command:

`[ :SOURce<hw> ] :BB:MCCW:CLOCK:MULTIPLIER` on page 620

**Measured External Clock**

Provided for permanent monitoring of the enabled and externally supplied clock signal.

Remote command:  
CLOCK:INPut:FREQuency?

### Global Settings

The buttons in this section lead to dialogs for general trigger, clock and mapping settings.

#### Global Trigger/Clock Settings

Calls the "Global Trigger/Clock/Input Settings" dialog.

This dialog is used among other things for setting the trigger threshold, the input impedance and the polarity of the clock and trigger inputs.

The parameters in this dialog affect all digital modulations and standards, and are described in chapter "Global Trigger/Clock/Input Settings" in the Operating Manual.

#### User Marker / AUX I/O Settings

Calls the "User Marker AUX I/O Settings" dialog, used to map the connector on the rear of the instruments.

See also "User Marker / AUX I/O Settings" in the Operating Manual.

## 5.8 External Baseband Signal - Baseband Input

The R&S AMU makes it possible to feed an external analog or digital baseband signal into the signal path.

User-specific wanted signals or interference signals can thus be added to internally generated signals, be frequency-shifted as well as loaded with a relative gain and subsequently - provided the instrument is fitted with the required options - be faded, detuned or loaded with noise (see description "Fading Simulator" and [Chapter 5.6, "Impairment of Digital I/Q Signal and Noise Generator - AWGN/IMP Block"](#), on page 222).

The equipment options for the basic unit includes the option R&S AMU-B17 (Baseband I/Q Input digital/analog) and the option R&S AMU-B13 (Baseband Main Module). If the R&S AMU is equipped with a baseband generator module (option R&S AMUB9/B10/B11, BasebandGenerator), internally generated signals can be added to the baseband input. If the R&S AMU is equipped with a fading simulator (option R&S AMU-B14, Fading Simulator and option R&S AMU, the Fading Simulator Extension), the signals can be faded. The fading module can also process external I/Q signals.

For two-path instruments, the external signal can be connected to baseband path A or path B. Up to two baseband input modules can be applied. The signal of the first baseband module can be routed to path A, path B or to both paths. The signal of the second baseband input module is firmly connected to pathB.

The R&S AMU is equipped with the following input interfaces:

- the I/Q connectors as input for the external analog signal  
The external analog signals are internally processed and A/D-converted.

The complex analog baseband input bandwidth is 60 MHz, i.e. the I and Q components of the signal are each filtered with a 30 MHz lowpass.

- the DIGITAL IQ IN at the rear of the instrument as input connector for the external digital signal  
This interface provides direct communication with other R&S instruments. Additionally, the external digital signal interface module (R&S EX-IQ-BOX) can be connected, providing parallel or serial signal transmission from external devices.



The signal source (typically a second R&S Instrument) and the receiving R&S Instrument have to be synchronized.

### 5.8.1 Important Signal Parameters

The correct signal processing of the externally supplied input signals in the instrument require information of some signal parameters, like sampling rate, crest factor and signal level, expressed as peak or as RMS level value.

- **Sample rate**

The sample rate of the input signal can be defined manually or automatically retrieved from the input signal.

- **Crest factor**

Test setups may require feeding of external signal to the digital/analog input of the R&S AMU. As a rule, whenever an I/Q signal is transferred between two instrument, the crest factor at the outputs of the "source" instrument has to match with the crest factor at the inputs of the receiving one.

The crest factor gives the difference in level between the peak level and RMS level value in dB (see [Figure 5-31](#)). The R&S AMU uses the crest factor value by the calculation of power levels. The general principle is, that the R&S AMU compensates the RMS levels of the externally supplied signal by the crest factor.

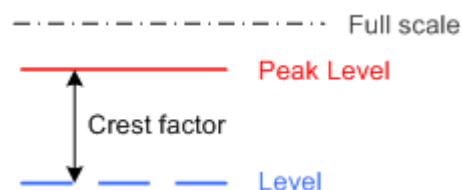

*Figure 5-31: Relation between the level settings*

In the instrument, level values are represented as relative to full scale.

#### Fulfilling the prerequisites for a correct signal processing of the externally supplied baseband signal

In the instrument, the **crest factor**, **peak level** and **RMS level** values can be adjusted in one of the following ways:

- Adjusted manually  
If you have knowledge about these values, it is best to enter them directly (see [Crest Factor](#))



- Estimated automatically by the internal measurement function  
Use the function [Auto Level Set](#) to trigger the R&S AMU to measure the input signal, estimate the the peak level and RMS level and calculate the crest factor out of them.  
**Tip:** To achieve correct signal leveling with external baseband signals, enable an appropriate measurement time and perform a measurement.  
For accurate level measurements, set the measurement period to a time value that is long enough to capture several periods of the input signal.
- Determined automatically (digital baseband input only)  
The R&S AMU can receive the values from the connected transmitter.  
If the external digital signal source is a second Rohde & Schwarz instrument, it signals the peak level and RMS level of the signal over the digital input interface. To enable the R&S AMU to receive these values, trigger the [DIG IQ Auto Setting](#) function.

In the two automatic way, the R&S AMU adjusts the corresponding input fields with the measured/received values. The internal gain control mechanism uses these received values to adjust the input signal gain to achieve an optimal dynamic range.

### Sample rate

- External input signals with sample rates different than the system clock are resampled, as illustrated on [Figure 5-32](#).

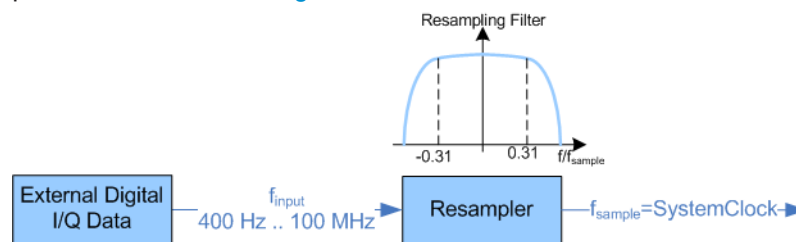

**Figure 5-32: Resampling principle of external digital baseband signals**

The R&S AMU can process digital signals with sample rate from 400 Hz to 100 MHz, where as the internal signal processing is based on a sample rate with 100 MHz.

- **Estimating or defining the sample rate**  
The sample rate of the signal at the digital interface can be determined with one of the following methods:
  - User-defined sample rate  
Provide both the external signal source and the receiving instrument with a common external reference signal and set the sample rate value.
  - Estimated sample rate  
Enable the instrument to evaluate the received I/Q data clock

### Maximum modulation bandwidth

- A baseband signal with a sample rate that is smaller than the used system clock is interpolated (see [Figure 5-32](#)). The resulting modulation bandwidth 40 MHz.

## 5.8.2 BB Input Block

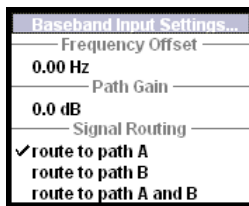

The settings for signal routing, frequency offset and path gain are available in the "BB Input" function block of each path or in the "BB Input" menus which are opened using the MENU key.

If an R&S EX-IQ-BOX is connected, the R&S instrument recognizes this module automatically and indicates a labeled symbol of the R&S EX-IQ-BOX at the corresponding function block. Additionally, the components of the recognized R&S EX-IQ-BOX are listed in the "Hardware Config", section "Baseband Assembly". A button for configuring the settings of the R&S EX-IQ-BOX is displayed in the "Baseband Input Settings" dialog (see "R&S EX-IQ-BOX Manual").

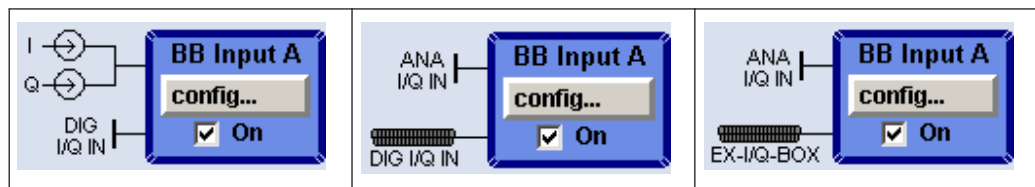

The external baseband signal is activated by switching on in the Baseband Input settings menu as well as by ticking the checkbox of the "BB Input" function block.

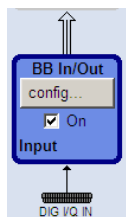

The "Baseband Input Settings" menu containing the external baseband signal settings is opened under the first item of the "BB Input" block menu (see [Chapter 5.8.2.1, "Baseband Input Settings Menu"](#), on page 370).

A frequency offset and a path gain can be set in the two following menu items of the "BB Input" block menu – provided the instrument is equipped with at least two baseband sources.

For two-path instruments the routing of the signals can be defined in the "Signal Routing" section of the "BB Input" block.

### 5.8.2.1 Baseband Input Settings Menu

The settings for the external baseband signal are available in the "BB Input" function block of each path or in the "BB Input" menus which are opened using the MENU key.

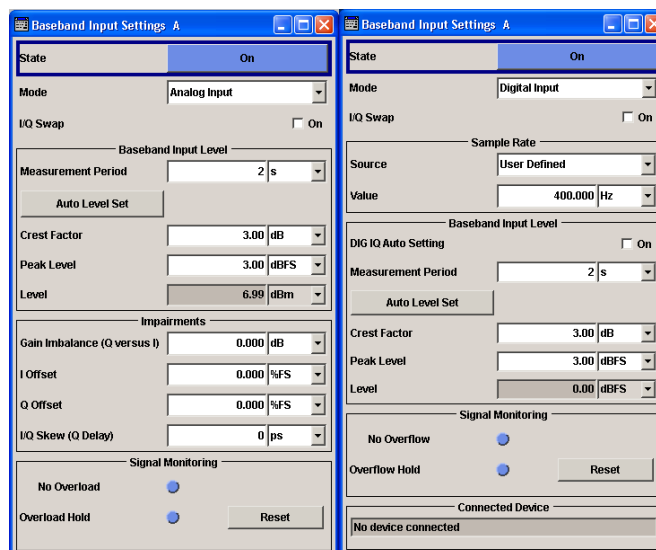

## Baseband Input General Settings

### State

Switches On/Off the feeding of an external analog or digital signal into the signal path. An external analog signal is A/D-converted and fed into path A or path B or into both paths simultaneously.

If no signal is applied at the input selected with parameter "Mode" an error message is displayed.

"On" Switches On the external I/Q input signal of the corresponding BB Input block. The input symbols display the active signal mode (digital DIG I/Q IN or analog I and Q).

"Off" Switches Off the external I/Q input signal of the corresponding BB Input block.

Remote command:

[ :SOURce<hw> ] :BBIN:STATe on page 635

### Mode

Selects the signal mode (analog or digital) of the external input signal for the BB Input block.

"Analog Input" An external analog baseband signal ("BB Input") is fed in via the "I" and "Q" analog inputs. The block diagram shows the BNC connectors at the "BB Input" block. The signals are A/D-converted using the 100MHz system clock and fed into the digital signal path.

"Digital Input" The external digital baseband signal is fed into the digital signal path via the Digital Input connector.  
The internal signal processing is based on a sample rate of 100MHz. External input signals with sample rates less than 100MHz are upsampled. The external sample rate can be estimated or defined by the user in the appropriate entry fields.

**Note:** This item is available only with BBinS Revision 05.02 or higher and BBinR Revision 02.06 or higher (see menu Setup-Hardware Config).

Remote command:

[ :SOURce<hw> ] :BBIN:MODE on page 630

### EX-I/Q-Box Settings...

Digital Input with connected R&S EX-IQ-BOX only.

Opens the main settings dialog of the R&S EX-IQ-BOX.

### I/Q-Swap

Activates swapping of the I and Q signal components, which mirrors the spectrum at the f=0 line and inverts the sign of the frequency.

The I/Q swap may be needed if an external CDMA signal is to be added to an internally generated baseband signal (see description "Digital Standard CDMA2000").

Remote command:

[ :SOURce<hw> ] :BBIN:IQSWap [ :STATe ] on page 630

### Sample Rate

For digital input signals the section "Sample Rate" is available in the "Baseband Input Settings" dialog. The sample rate of the external digital baseband signal can be set and the state of signal transmission is indicated by the FIFO Status.

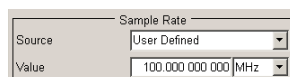

### Sample Rate Source

Digital Input only

Selects the source for estimating the sample rate or defining it by the user.

**Note:** With a connected "R&S EX-IQ-BOX" either the internal clock source (User defined) or an external clock (Digital I/Q In) can be selected in the settings dialog of the R&S EX-IQ-BOX. Therefore, the sample rate source is only indicated in this field.

"User Defined" Enables the user to define the sample rate in the entry field value.

"Digital I/Q In" Estimates the sample rate on the digital I/Q input and displays the value in the value field.

**Note:** Estimation works best if the sample rate is close to the user defined value.

Remote command:

[ :SOURce<hw> ] :BBIN:SRATe:SOURce on page 635

**Sample Rate Value**

Digital Input only

Sets the sample rate of the external digital baseband input signal.

**Note:** The maximum value is 90 MHz with BBinR Revision 02.xx and 100 MHz with BBinR Revision 03.00 or higher.

Remote command:

[\[:SOURce<hw>\]:BBIN:SRATe\[:ACTual\]?](#) on page 634**FIFO Status**

Digital Input only

Indicates the state of the signal transmission.

**Note:** The FIFO status is a SCPI parameter that is not displayed in the GUI.

"OK" Resampling is working properly.

"OFL = Over-flow" The external sample rate frequency is too high which causes an overflow in signal transmission.

"URUN = Underrun" The external sample rate frequency is too low which causes an underrun in signal transmission.

Remote command:

[\[:SOURce<hw>\]:BBIN:SRATe:FIFO\[:STATus\]?](#) on page 635**Baseband Input Level**

The crest factor and the peak power of the external baseband signal are entered in the section "Baseband Input Level". These values are necessary for a correct internal signal processing in the R&S AMU. They can also be automatically estimated by a measurement using the "Auto Level Set" button.

**DIG IQ Auto Setting**

Activates automatic adjustment of the baseband input signal.

The R&amp;S AMU receives Peak Level, level and crest factor values directly from the connected transmitter and recognizes changes automatically.

See also ["Fulfilling the prerequisites for a correct signal processing of the externally supplied baseband signal"](#) on page 368.

Remote command:

[\[:SOURce<hw>\]:BBIN:DIGital:ASETting:STATe](#) on page 629

**Measurement Period**

Sets the recording duration for measuring the baseband input signal by "Auto Level Set". For accurate level measurements, the measurement period should be set to a time value that is long enough to capture several periods of the input signal.

Remote command:

`[ :SOURce<hw> ] :BBIN:MPERiod` on page 631

**Auto Level Set**

Starts measuring the input signal. The measurement estimates the crest factor, the peak power and the rms power. The estimated values are automatically entered into the input fields "Crest Factor", "Peak Level" and "Level". Using these estimated values the internal gain control adjusts the input signal gain to achieve an optimal dynamic range.

See also ["Fulfilling the prerequisites for a correct signal processing of the externally supplied baseband signal"](#) on page 368.

Remote command:

`[ :SOURce<hw> ] :BBIN:ALEVel:EXECute` on page 628

**Crest Factor**

Sets the crest factor of the external analog or digital baseband signal. Indicates the crest factor acquired with "Auto Level Set".

See also ["Fulfilling the prerequisites for a correct signal processing of the externally supplied baseband signal"](#) on page 368.

Remote command:

`[ :SOURce<hw> ] :BBIN:CFACTOR` on page 629

**Peak Level**

Enters the peak level of the external analog or digital baseband signal relative to full scale of 0.5 V (in terms of dB full scale).

Indicates the peak level acquired with "Auto Level Set".

Remote command:

`[ :SOURce<hw> ] :BBIN:POWer:PEAK` on page 633

**Level**

Indicates the estimated rms level acquired with "Auto Level Set".

Remote command:

`[ :SOURce<hw> ] :BBIN:POWer:RMS?` on page 633

**Impairments**

For analog input signals the section "Impairments" is available in the "Baseband Input Settings" dialog. Additionally to the internal calibration of the instrument a DC offset, gain imbalance and time delay can be set to I and Q signal components. The section Signal Monitoring indicates the overload of the A/D - Converter.

Impairments		
Gain Imbalance (Q versus I)	0.000	dB
I Offset	0.000	%FS
Q Offset	0.000	%FS
I/Q Skew (Q Delay)	0.000	ns

### Gain Imbalance (Q versus I)

Analog Input only

Enables to amplify the Q component of the input signal additionally to the internal calibration. This setting is needed e.g. to balance the I and Q signal channel by exactly the same degree.

Remote command:

[\[:SOURCE<hw>\]:BBIN:GIMBalance](#) on page 630

### I Offset

Analog Input only

Sets a DC offset to the I component of the input signal additionally to the internal calibration. This setting is needed to compensate an offset that has been fed in from the external signal.

Remote command:

[\[:SOURCE<hw>\]:BBIN:OFFSet:I](#) on page 631

### Q Offset

Analog Input only

Sets a DC offset to the Q component of the input signal additionally to the internal calibration. This setting is needed to compensate an offset that has been fed in from the external signal.

Remote command:

[\[:SOURCE<hw>\]:BBIN:OFFSet:Q](#) on page 631

### I/Q-Skew (Q Delay)

Analog Input only

Determines the delay between Q and I channel. Positive values represent a delay for Q versus I.

Remote command:

[\[:SOURCE<hw>\]:BBIN:SKEW](#) on page 634

### Signal Monitoring

The section "Signal Monitoring" indicates the overload of the A/D - Converter.

Signal Monitoring	
No Overflow	<input checked="" type="radio"/>
Overflow Hold	<input checked="" type="radio"/>
<input type="button" value="Reset"/>	

**Overload**

Indicates that the I/Q input is currently overloaded. This indication also appears in the block diagram close to the I/Q connector of the Baseband Input block.

If overload is indicated either the amplitude of the external signal is too high (full scale of 0.5 V) and must be reduced or the entered "Peak Level" (in dB full scale) value does not correspond with the real value and must be corrected. It also can be evaluated automatically with button "Auto Level Set".

Remote command:

`[ :SOURce<hw> ] :BBIN:OLOad:STATe?` on page 632

**Overload Hold**

Indicates an overload since last reset for evaluating the measurement.

The Overload Hold state can be reset via the "Reset" button next to the LED, or is reset automatically by starting a new measurement ("Auto Level Set") or by setting new values (Crest Factor, Peak Level, Level).

Remote command:

`[ :SOURce<hw> ] :BBIN:OLOad:HOLD:STATe?` on page 632

**Reset**

Executes a reset of the "Overload Hold" state and LED.

Remote command:

`[ :SOURce<hw> ] :BBIN:OLOad:HOLD:STATe?` on page 632

**Connected Device**

Digital Input only

Indicates the ID of a connected R&S Instrument or R&S device.

If supported by the transmitter, also the transmitter sample rate is shown.

Remote command:

`[ :SOURce<hw> ] :BBIN:CDEvice?` on page 628

### 5.8.2.2 Signal Routing and Frequency Shifting

A frequency offset and a path gain can be set in the corresponding menu items of the "BB Input" block menu.

For two-path instruments, the routing of the signals can be defined in the "Signal Routing" section of the "BB Input block".

The section "Path Gain" is used to enter the relative gain of the external signal compared with the signals of the other baseband sources.

The section "Signal Routing" is used to define the signal routes of a external baseband signals in two-path instruments.

**Frequency Offset**

Enters the frequency offset for the external baseband signal. It shifts the useful baseband signal in the center frequency.

The offset affects the signal on the output of the "Baseband" block.



**Note:** For sample rates of exactly 100 MHz (Baseband In Mode Digital Input, i.e. Sample Rate Source User Defined) it is not possible to enter a frequency offset. The digital signal is fed into the signal path directly and not routed to the resampler where the frequency offset takes place.

The complex I/Q bandwidth of the shifted useful signal must not exceed the total available baseband bandwidth (see data sheet). The setting range of the frequency offset is then calculated as described in "Frequency Offset" on page 237.

Remote command:

[ :SOURce<hw> ] :BBIN:FOFFset on page 629

### Path Gain

Enters the relative gain for the external baseband signal compared with the signals of the other baseband sources. The gain affects the signal on the output of the "BB Input" block.

**Note:** In case the baseband signal is additionally faded and routed at the output of the fading simulator, so that the faded signals from both paths are summed, the real path gain is measured at the output of the "Fading" block and set with the fading parameter "Summation Ratio A/B" (see description "Fading Simulator", section "Summation Ratio A/B").

The relative gain set with the parameter "Path Gain" in the "Baseband" block is ignored.

The "Path Gains" of the different baseband sources (Baseband In A, Baseband In B, Baseband A and Baseband B) determine the gain of the associated signals relative to each other. The actual gain of the different baseband signals depends not only on the path gain setting but also on the signal characteristics like the crest factor, on the number of used sources and on the total output level.

The cumulative baseband signal can be verified in the "Graphics" block in the spectrum view.

Remote command:

[ :SOURce<hw> ] :BBIN:PGAin on page 632

### Signal Routing

Selects the signal routes of external baseband signals in a two-path instrument. Up to two baseband input modules can be applied. The signal of the first baseband module can be routed to path A, path B or to both paths.

**Note:** The second baseband input module Baseband Input B is firmly connected to signal path B. Therefore no routing is provided for this block.

The following table shows some of the possible combinations of signal routes for two-path instruments.

**Note:** The table shows some possible combinations of signal routes in a two-path instrument, containing four signal sources. On the basis of Routing baseband block A to path A the signal routings are shown. Routing baseband block A to path B or Routing baseband block A to path A + B similar routing combinations are possible for the remaining signal sources (Baseband In A, Baseband B and Baseband In B). These possibilities are unlisted to limit the number of figures in the table.

Table 5-15: Combinations of signal routings for two-path instruments

Routing baseband A	Routing baseband In A	Routing baseband In B	Routing baseband B	Block diagram
Route to path A	Route to path A	Route to path B	Route to path A	
Route to path A	Route to path A	Route to path B	Route to path B	
Route to path A	Route to path A	Route to path B	Route to path A + B	
Route to path A	Route to path B	Route to path B	Route to path A	
Route to path A	Route to path B	Route to path B	Route to path B	
Route to path A	Route to path B	Route to path B	Route to path A + B	

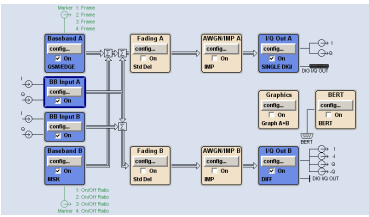
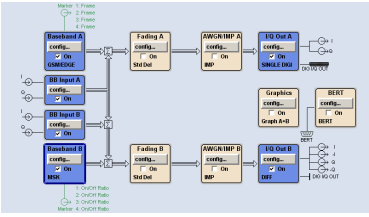
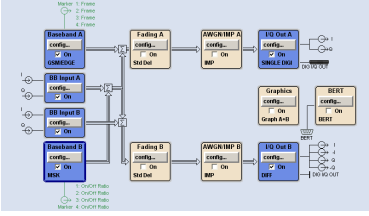
Routing baseband A	Routing baseband In A	Routing baseband In B	Routing baseband B	Block diagram
Route to path A	Route to path A + B	Route to path B	Route to path A	
Route to path A	Route to path A + B	Route to path B	Route to path B	
Route to path A	Route to path A + B	Route to path B	Route to path A + B	

"Route to path A" The external baseband signal is fed into pathA. If an internal signal from pathA is generated at the same time, the two signals are summed.

"Route to path B" The external baseband signal is fed into path B. If an internal signal from pathB is generated at the same time, the two signals are summed.

"Route to path A and B" The external baseband signal is fed into path A and path B. If internal signals from one or two paths are generated at the same time, all signals in each path are summed.

Remote command:

[ :SOURce<hw> ] :BBIN:ROUTe on page 633

External Baseband Signal - Baseband Input

## 6 Remote Control Basics

This chapter provides basic information on operating an instrument via remote control.

### 6.1 Remote Control Interfaces and Protocols

The instrument supports different interfaces for remote control. The following table gives an overview.

**Table 6-1: Remote control interfaces and protocols**

Interface	Protocols, VISA <sup>*)</sup> address string	Remarks
Local Area Network (LAN)	Protocols: <ul style="list-style-type: none"> <li>VXI-11 VISA<sup>*)</sup> address string: TCP/IP::host address[:: LAN device name][::INSTR]</li> <li>socket communication (Raw Ethernet, simple telnet) VISA<sup>*)</sup> address string: TCP/IP::host address[:: LAN device name&gt;::&lt;port&gt;:: SOCKET</li> </ul>	A LAN connector is located on the front or rear panel of the instrument, or both.  The interface is based on TCP/IP and supports various protocols.  For a description of the protocols refer to: <ul style="list-style-type: none"> <li>Chapter 6.1.3.2, "VXI-11 Protocol", on page 385</li> <li>Chapter 6.1.3.3, "Socket Communication", on page 385</li> </ul>
GPIB (IEC/IEEE Bus Interface)	VISA <sup>*)</sup> address string: GPIB::primary address[::INSTR]  (no secondary address)	Optional GPIB bus interfaces according to standard IEC 625.1/IEEE 488.1 are located on the rear panel of the instrument.  For a description of the interface refer to Chapter 6.1.4, "GPIB Interface (IEC/IEEE Bus Interface)", on page 386.  <b>Note:</b> Within this interface description, the term GPIB is used as a synonym for the IEC/IEEE bus interface.

<sup>\*)</sup> VISA is a standardized software interface library providing input and output functions to communicate with instruments. A VISA installation on the controller is a prerequisite for remote control over LAN (when using VXI-11 or HiSLIP protocol), USB and serial interface. For remote control via socket communication VISA installation is optional. For more information, see Chapter 6.1.1, "VISA Libraries", on page 382.



Rohde & Schwarz provides the standardized I/O software library R&S VISA for communication via TCP/IP (LAN: HiSLIP, VXI-11 and raw socket), USB (USBTMC) or serial interfaces.

R&S VISA is available for download at the Rohde & Schwarz website <http://www.rohde-schwarz.com/rsvisa>.

How to configure the remote control interfaces, see Chapter 6.2, "Starting a Remote Control Session", on page 388.

#### SCPI (Standard Commands for Programmable Instruments)

SCPI commands - messages - are used for remote control. Commands that are not taken from the SCPI standard follow the SCPI syntax rules. The instrument supports the SCPI version 1999. The SCPI standard is based on standard IEEE 488.2 and aims

at the standardization of device-specific commands, error handling and the status registers. The tutorial "Automatic Measurement Control - A tutorial on SCPI and IEEE 488.2" from John M. Pieper (R&S order number 0002.3536.00) offers detailed information on concepts and definitions of SCPI.

Tables provide a fast overview of the bit assignment in the status registers. The tables are supplemented by a comprehensive description of the status registers.

### 6.1.1 VISA Libraries

VISA is a standardized software interface library providing input and output functions to communicate with instruments. Thus, you can configure the interface without having to adjust the application program to the used interface. The I/O channel (LAN or TCP/IP, USB, GPIB,...) is selected at initialization time by means of the channel-specific address string ("VISA resource string"), or by an appropriately defined VISA alias (short name). See also [Chapter 6.1, "Remote Control Interfaces and Protocols"](#), on page 381 for an overview.

Instrument access via VXI-11 or HiSLIP protocols is achieved from high level programming platforms using VISA as an intermediate abstraction layer. VISA encapsulates the low-level VXI or GPIB function calls and thus makes the transport interface transparent for the user.

A VISA installation is a prerequisite for remote control using the following interfaces:

- LAN Interface using [Chapter 6.1.3, "LAN Interface"](#), on page 383
- LAN interface using [Chapter 6.1.3.2, "VXI-11 Protocol"](#), on page 385
- [Chapter 6.1.4, "GPIB Interface \(IEC/IEEE Bus Interface\)"](#), on page 386

Instrument access via the LAN socket protocol or GPIB connections can be operated both, with or without the VISA library.

See also [Chapter 6.1.3.3, "Socket Communication"](#), on page 385 and [Chapter 6.1.4, "GPIB Interface \(IEC/IEEE Bus Interface\)"](#), on page 386.

For more information about VISA refer to the user documentation.

### 6.1.2 Messages

The messages transferred on the data lines are divided into the following categories:

- Interface messages  
Interface messages are transmitted to the instrument on the data lines, with the attention line being active (LOW). They are used to communicate between the controller and the instrument. Interface messages can only be sent by instruments that have GPIB bus functionality. For details see the sections for the required interface.
- Instrument messages  
Instrument messages are employed in the same way for all interfaces, if not indicated otherwise in the description. Structure and syntax of the instrument messages are described in [Chapter 6.3, "SCPI Command Structure"](#), on page 404. A detailed

description of all messages available for the instrument is provided in the chapter "Remote Control Commands".

There are different types of instrument messages, depending on the direction they are sent:

- Commands
- Instrument responses

### Commands

Commands (program messages) are messages the controller sends to the instrument. They operate the instrument functions and request information. The commands are subdivided according to two criteria:

- According to the effect they have on the instrument:
  - **Setting commands** cause instrument settings such as a reset of the instrument or setting the frequency.
  - **Queries** cause data to be provided for remote control, e.g. for identification of the instrument or polling a parameter value. Queries are formed by directly appending a question mark to the command header.
- According to their definition in standards:
  - **Common commands**: their function and syntax are precisely defined in standard IEEE 488.2. They are employed identically on all instruments (if implemented). They refer to functions such as management of the standardized status registers, reset and self-test.
  - **Instrument control commands** refer to functions depending on the features of the instrument such as frequency settings. Many of these commands have also been standardized by the SCPI committee. These commands are marked as "SCPI confirmed" in the command reference chapters. Commands without this SCPI label are device-specific; however, their syntax follows SCPI rules as permitted by the standard.

### Instrument responses

Instrument responses (response messages and service requests) are messages the instrument sends to the controller after a query. They can contain measurement results, instrument settings and information on the instrument status.

## 6.1.3 LAN Interface

To be integrated in a LAN, the instrument is equipped with a LAN interface, consisting of a connector, a network interface card and protocols. For remote control via a network, the PC and the instrument must be connected via the LAN interface to a common network with TCP/IP network protocol. They are connected using a commercial RJ45 cable. The TCP/IP network protocol and the associated network services are preconfigured on the instrument. Software for instrument control and (for specified protocols only) the VISA program library must be installed on the controller.

### VISA library

Instrument access via VXI-11 protocols is usually achieved from high level programming platforms using VISA as an intermediate abstraction layer. VISA encapsulates the low level VXI or GPIB function calls and thus makes the transport interface transparent for the user. See [Chapter 6.1.1, "VISA Libraries"](#), on page 382 for details.

### IP address

Only the IP address or the computer name (LAN device name) is required to set up the connection. The IP address/computer name is part of the "visa resource string" used by the programs to identify and control the instrument.

Forms of the VISA resource string:

```
TCPIP::host address[::LAN device name][::INSTR]
```

or

```
TCPIP::host address::port::SOCKET
```

where

- **TCPIP** designates the network protocol used
- **host address** is the IP address or host name of the device
- **LAN device name** defines the protocol and the instance number of a sub-instrument:
  - `inst0` selects the VXI-11 protocol (optional, default)
  - `hislip0` selects the newer HiSLIP protocol
- **INSTR** indicates the instrument resource class (optional)
- **port** determines the used port number
- **SOCKET** indicates the raw network socket resource class

### Example:

- Instrument has the IP address `192.1.2.3`; the valid resource string using VXI-11 protocol is:  

```
TCPIP::192.1.2.3::INSTR
```
- The DNS host name name is `RSSM1`; the valid resource string is:  

```
TCPIP::RSSM1::hislip0 (HiSLIP)
```

```
TCPIP::RSSM1::INSTR (VXI-11)
```
- A raw socket connection can be established using:  

```
TCPIP::192.1.2.3::5025::SOCKET
```



### Identifying instruments in a network

If several instruments are connected to the network, each instrument has its own IP address and associated resource string. The controller identifies these instruments by the resource string.



### 6.1.3.1 HiSLIP Protocol

The HiSLIP (**H**igh **S**peed **L**AN **I**nstrument **P**rotocol) is the successor protocol for VXI-11 for TCP-based instruments specified by the IVI foundation. The protocol uses two TCP sockets for a single connection - one for fast data transfer, the other for non-sequential control commands (e.g. `Device Clear` or `SRQ`).

HiSLIP has the following characteristics:

- High performance as with raw socket network connections
- Compatible IEEE 488.2 support for Message Exchange Protocol, Device Clear, Serial Poll, Remote/Local, Trigger, and Service Request
- Uses a single IANA registered port (4880), which simplifies the configuration of firewalls
- Supports simultaneous access of multiple users by providing versatile locking mechanisms
- Usable for IPv6 or IPv4 networks



Using VXI-11, each operation is blocked until a VXI-11 device handshake returns. However, using HiSLIP, data is sent to the device using the "fire and forget" method with immediate return. Thus, a successful return of a VISA operation such as `viWrite()` does not guarantee that the instrument has finished or started the requested command, but is delivered to the TCP/IP buffers.

---

For more information see also the application note: [1MA208: Fast Remote Instrument Control with HiSLIP](#).

### 6.1.3.2 VXI-11 Protocol

The VXI-11 standard is based on the ONC RPC (Open Network Computing Remote Procedure Call) protocol which in turn relies on TCP/IP as the network/transport layer. The TCP/IP network protocol and the associated network services are preconfigured. TCP/IP ensures connection-oriented communication, where the order of the exchanged messages is adhered to and interrupted links are identified. With this protocol, messages cannot be lost.

### 6.1.3.3 Socket Communication

An alternative way for remote control of the software is to establish a simple network communication using sockets. The socket communication, also referred to as "Raw Ethernet communication", does not necessarily require a VISA installation on the remote controller side. It is available by default on all operating systems.

The simplest way to establish socket communication is to use the built-in telnet program. The telnet program is part of every operating system and supports a communication with the software on a command-by-command basis. For more convenience and to enable automation by means of programs, user-defined sockets can be programmed.

Socket connections are established on a specially defined port. The socket address is a combination of the IP address or the host name of the instrument and the number of the port configured for remote-control. All R&S AMU use port number 5025 for this purpose. The port is configured for communication on a command-to-command basis and for remote control from a program.

#### 6.1.3.4 LAN Interface Messages

In the LAN connection, the interface messages are called low-level control messages. These messages can be used to emulate interface messages of the GPIB bus.

Command	Long term	Effect on the instrument
&ABO	Abort	Aborts processing of the commands just received.
&DCL	Device Clear	Aborts processing of the commands just received and sets the command processing software to a defined initial state. Does not change the instrument setting.
&GTL	Go to Local	Transition to the "local" state (manual control). (The instrument automatically returns to remote state when a remote command is sent UNLESS &NREN was sent before.)
&GTR	Go to Remote	Enables automatic transition from local state to remote state by a subsequent remote command (after &NREN was sent).
&GET	Group Execute Trigger	Triggers a previously active instrument function (e.g. a sweep). The effect of the command is the same as with that of a pulse at the external trigger signal input.
&LLO	Local Lockout	Disables transition from remote control to manual control by means of the front panel keys.
&NREN	Not Remote Enable	Disables automatic transition from local state to remote state by a subsequent remote command. (To re-activate automatic transition use &GTR.)
&POL	Serial Poll	Starts a serial poll.

#### 6.1.4 GPIB Interface (IEC/IEEE Bus Interface)

To be able to control the instrument via the GPIB bus, the instrument and the controller must be linked by a GPIB bus cable. A GPIB bus card, the card drivers and the program libraries for the programming language used must be provided in the controller. The controller must address the instrument with the GPIB bus address (see [Chapter 6.1.4.2, "GPIB Instrument Address"](#), on page 388).

##### Characteristics

The GPIB interface is described by the following characteristics:

- Up to 15 instruments can be connected
- The total cable length is restricted to a maximum of 15 m; the cable length between two instruments should not exceed 2m.

- A wired "OR"-connection is used if several instruments are connected in parallel, since the slowest instrument determines the speed.



Any connected IEC bus cable must be terminated by an instrument or controller.

#### 6.1.4.1 GPIB Interface Messages

Interface messages are transmitted to the instrument on the data lines, with the attention line (ATN) being active (LOW). They are used for communication between the controller and the instrument and can only be sent by a computer which has the function of a GPIB bus controller. GPIB interface messages can be further subdivided into:

- **Universal commands:** act on all instruments connected to the GPIB bus without previous addressing
- **Addressed commands:** only act on instruments previously addressed as listeners

##### Universal Commands

Universal commands are encoded in the range 10 through 1F hex. They affect all instruments connected to the bus and do not require addressing.

Command	Effect on the instrument
DCL (Device Clear)	Aborts the processing of the commands just received and sets the command processing software to a defined initial state. Does not change the instrument settings.
IFC (Interface Clear *)	Resets the interfaces to the default setting.
LLO (Local Lockout)	The LOC/IEC ADDR key is disabled.
SPE (Serial Poll Enable)	Ready for serial poll.
SPD (Serial Poll Disable)	End of serial poll.
PPU (Parallel Poll Unconfigure)	End of the parallel-poll state.
*) IFC is not a real universal command, it is sent via a separate line; however, it also affects all instruments connected to the bus and does not require addressing	

##### Addressed Commands

Addressed commands are encoded in the range 00 through 0F hex. They only affect instruments addressed as listeners.

Command	Effect on the instrument
GET (Group Execute Trigger)	Triggers a previously active instrument function (e.g. a sweep). The effect of the command is the same as with that of a pulse at the external trigger signal input.
GTL (Go to Local)	Transition to the "local" state (manual control).
GTR (Go to Remote)	Transition to the "remote" state (remote control).

Command	Effect on the instrument
PPC (Parallel Poll Configure)	Configures the instrument for parallel poll.
SDC (Selected Device Clear)	Aborts the processing of the commands just received and sets the command processing software to a defined initial state. Does not change the instrument setting.

#### 6.1.4.2 GPIB Instrument Address

In order to operate the instrument via remote control, it must be addressed using the GPIB address. The remote control address is factory preset, but it can be changed if it does not fit in the network environment. For remote control, addresses 0 through 30 are allowed. The GPIB address is maintained after a reset of the instrument settings.

##### Changing the GPIB address of the instrument

The GPIB address can be changed manually or using a remote control command.

1. Manually: press the SETUP key and select "Remote > GPIB".



Select parameter "GPIB channel address" and set the GPIB address.

2. Using remote control command:

```
SYST:COMM:GPIB:ADDR 18
```

#### 6.1.5 LXI Browser Interface

LAN extension for instrumentation (LXI) is an instrumentation platform for measuring instruments and test systems that is based on standard Ethernet technology, see also [Chapter 2.9, "LXI Configuration"](#), on page 60.

The LXI browser interface allows easy configuration of the LAN and remote control of the R&S AMU without additional installation requirements. The instrument's LXI browser interface works correctly with all W3C compliant browsers.

The LAN settings are configured using the LXI Browser Interface of the R&S AMU described in [Chapter 2.9.2, "LAN Configuration"](#), on page 64. The LXI status settings in the R&S AMU are described in [Chapter 5.2.3.13, "LXI Status"](#), on page 156.

## 6.2 Starting a Remote Control Session

The instrument and the controller have to be connected with the suitable cable and switched on.

A remote control program must open a connection to the instrument (using VISA functionality), before it can send commands to and receive device responses from the instrument.



### Instrument Address

In order to operate the instrument via remote control it must be addressed using the defined interface address. See [Chapter 6.1.3, "LAN Interface"](#), on page 383, [Chapter 6.1.4, "GPIB Interface \(IEC/IEEE Bus Interface\)"](#), on page 386 or [Chapter 6.1.5, "LXI Browser Interface"](#), on page 388 for details.

The VISA resource strings are indicated in the "Setup > Remote Channel Settings" menu.

---



### Securing the display

To prevent unauthorized personnel from reading the display, you can disable the frequency and level display explicitly. This is useful when you remotely control the instrument from a different location.

For information on how to disable the frequency and level display, refer to ["Annotation Frequency"](#) on page 160 and ["Annotation Amplitude"](#) on page 160.

---

Refer to [Chapter 6.2.3, "Examples"](#), on page 391 for practical examples on setting up of a remote control link and starting of a remote control session.

## 6.2.1 Switching to Remote Control

After switching on, the instrument is usually in the local state and can be operated via the front panel controls (for instruments equipped with a display), a mouse and an external keyboard.

### Starting remote control

1. Send a command from a controller to the instrument.

The instrument changes to remote state as soon as it receives the command from the controller.

**Note:** If you have sent `&NREN` before, the automatic transition from local state to manual control by a subsequent remote command is disabled (use `&GTR` to enable it again).

In remote state, operation via the front panel or via mouse and keyboard is disabled. The status line indicates the "REMOTE" state.

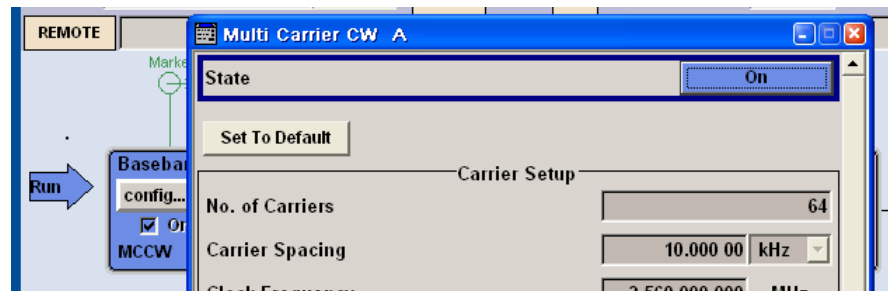

The instrument remains in the remote state until it is reset to the local state, see [Chapter 6.2.2, "Returning to Manual Operation"](#), on page 390).

**Tip:** Switching from manual operation to remote control and vice versa does not affect the other instrument settings.

- Although operation via front panel, mouse and keyboard is disabled, the dialog boxes can still be opened, for example to verify settings. The buttons and setting fields are grayed out and cannot be activated. Additionally, you can disable the access to the dialogs with the command `SYST:KLOC ON` to protect the instrument against unauthorized readings.
- To prevent unintentional return to manual operation, disable the LOCAL key of the instrument with the `&LLO` command (see [Chapter 6.1.3.4, "LAN Interface Messages"](#), on page 386).

The instrument switches to "REM-LLO" state.

The automatic transition from local state to remote state by a subsequent remote command, and the command `*GTL` are disabled.

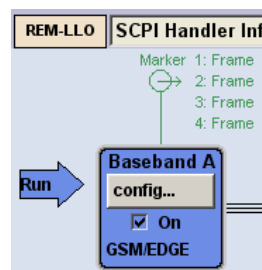

To return to manual mode is only possible via remote control.

- Unlock the LOCAL key with `&GTR`.

## 6.2.2 Returning to Manual Operation



Before returning to manual control, command processing must be completed. Otherwise, the instrument switches back to remote control immediately.

To return to manual operation, perform one of the following:

- Press the LOCAL key on the front panel.

- Select "Setup > Remote Control Channels > Local".
- While using the socket communication, terminate the remote control session.
- Send the interface command `&GTL` via the remote control interface.



Use the `&GTR` to enable the LOCAL key if it is locked.

### 6.2.3 Examples

This sections provides examples for setting up the remote control connection, and starting a remote control session.

This section assumes basic knowledge of programming and operation of the controller. A description of the interface commands can be obtained from the corresponding manuals.

#### 6.2.3.1 Remote Control over GPIB

The program example in this section is written in VISUAL BASIC. A condition for programming in VISUAL BASIC is that the modules NIGLOBAL (`Niglobal.bas`) and VBIB32 (`Vbib_32.bas`) are added to the projects.



Drivers for instrument, e.g. IVI-COM and LabVIEW drivers, are available in the download area of the product website ([http://www.rohde-schwarz.com/en/products/test\\_and\\_measurement/product\\_categories/signal\\_generation/](http://www.rohde-schwarz.com/en/products/test_and_measurement/product_categories/signal_generation/)).

#### Starting a remote control session over GPIB

As a prerequisite, the GPIB address of the instrument, which is factory-set to 28, must not have been changed.

1. Connect instrument and controller using GPIB cable and switch them on.
2. Execute following commands on the controller:
  - a) Open port to the instrument  
`CALL IBFIND("DEV1", generator%)`
  - b) Inform controller about instrument address  
`CALL IBPAD(generator%, 28)`
  - c) Reset instrument  
`CALL IBWRT(generator%, "*RST;*CLS")`
  - d) Set instrument to new address  
`CALL IBWRT(generator%, "SYST:COMM:GPIB:ADDR 18")`
  - e) Inform controller about new address  
`CALL IBPAD(generator%, 18)`

The GPIB address of the instrument is changed.

3. To return to manual operation sent `CALL IBLOC (generator%)` or press the LOCAL key at the front panel.

### 6.2.3.2 Remote Control over LAN using VXI-11 Protocol

In this example, the I/O software library R&S VISA from Rohde & Schwarz is used to set up a LAN remote control link and remotely control the R&S AMU. R&S VISA is running on a controller PC with Windows operating system. When the connection is set up you can send commands to the instrument, and receive the responses.

The remote control connection requires a VISA installation but no additional hardware on the controller PC. The LAN I/O channel is selected at initialization time using the VISA resource string (also referred to as "address string"). A VISA alias (short name) is used to replace the complete resource string. The host address is either the R&S AMU's hostname or IP address. See also [Chapter 6.1.3, "LAN Interface"](#), on page 383.



In this example, it is assumed that:

- A LAN remote control link between the controller and the R&S AMU is already set up.
- The R&S VISA program is installed on the remote PC, see "<http://www.rohde-schwarz.com/rsvisa> > RS VISA Release Notes".

---

#### Configuring the controller

To remote control the R&S AMU, we use the R&S VISA Tester application.



The instrument is preconfigured for networks using DHCP (dynamic host configuration protocol). If this configuration is used, enter the computer name in the position of the IP address.

---

To enable the external controller to communicate with the R&S AMU via TCP/IP protocol, set up a remote control link as follows:

1. Make sure that the controller and the instrument are connected in the network (network cable) and switched on.
2. On the controller, start "R&S VISA > Tester 32bit" or "R&S VISA > Tester 64bit", respectively.



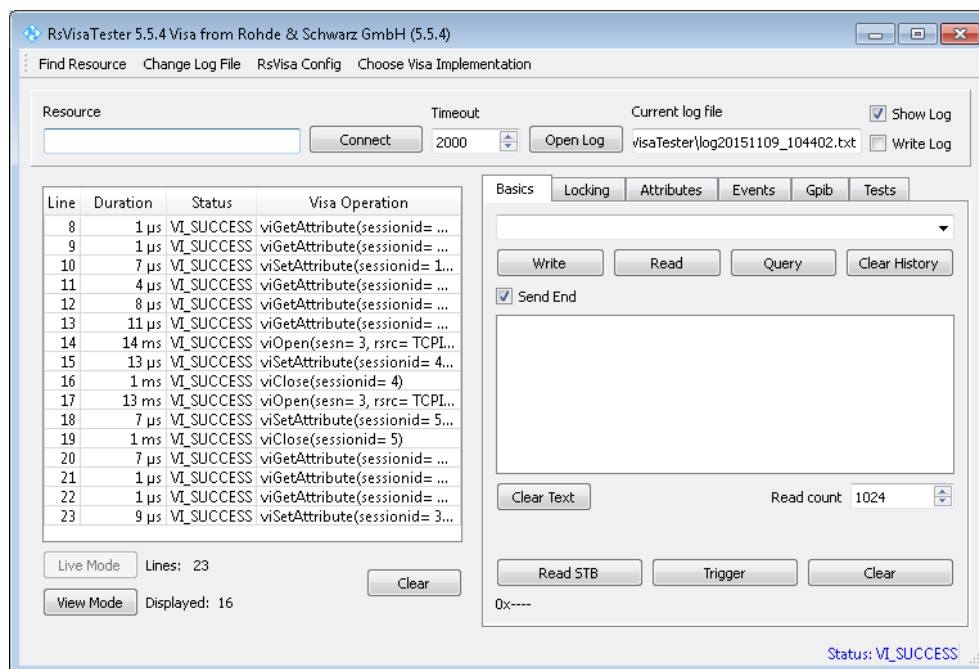

- In the menu bar, select "Choose VISA Implementation > Rohde & Schwarz Visa".

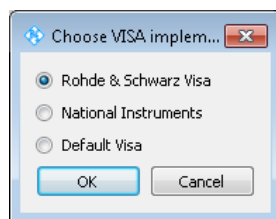

- Select "Rohde & Schwarz Visa" and confirm with "OK".
- In the menu bar, select "Find Resource" to search for the instrument in the LAN.

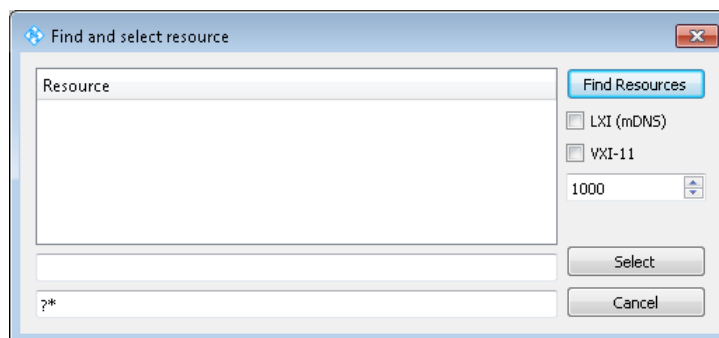

- Select "VXI-11" and "Find Resources".  
R&S VISA scans the network for connected instruments and lists all detected instruments in the "Resource" list.  
**Note:** The search may take some time, particularly in large networks.
- Select the required instrument and confirm with "Select".

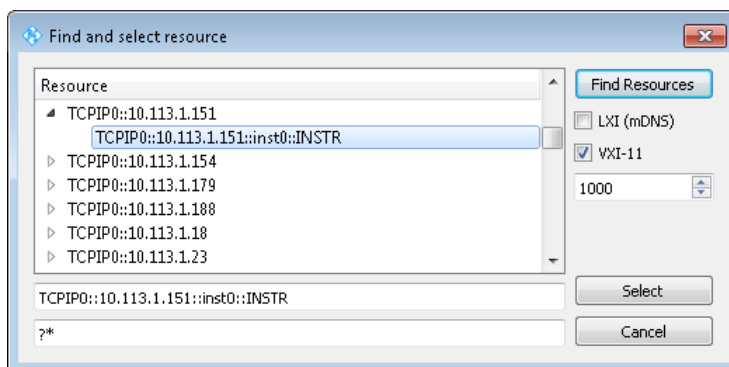

The "Find and select resource" dialog closes and R&S VISA indicates the instruments IP address in the "Resource" field of the main application window.

8. As an alternative to the IP address, you can assign an alias name to the R&S AMU:
  - a) In the menu bar, select "RsVisaConfig".

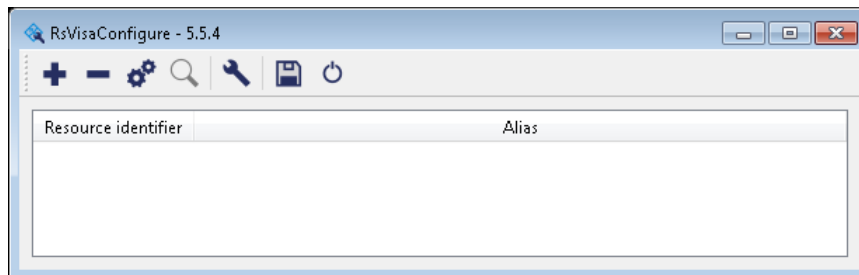

- b) In the toolbar, select "+" to access the "VISA Resource String Composer".

- c) Fill in the "Alias" name, the "VISA Resource String" and the "Device IP Address or host name" as shown in the figure, and confirm with "OK".

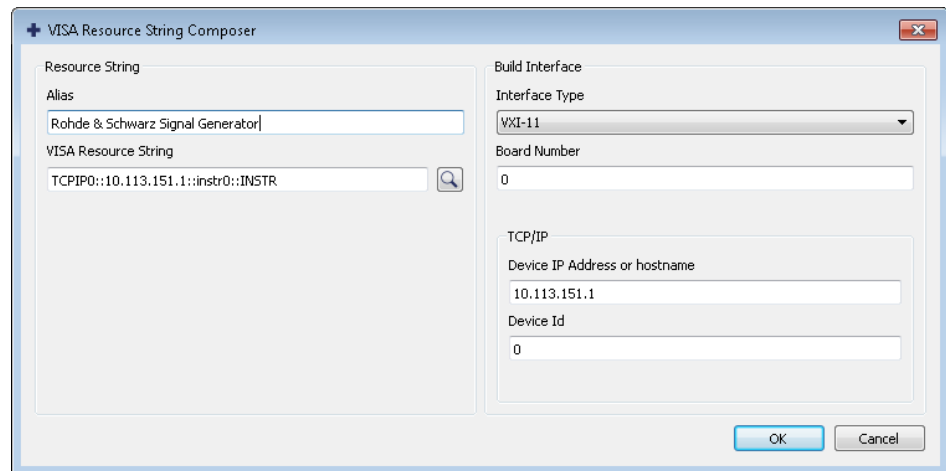

The "Alias" name is assigned to the instrument.

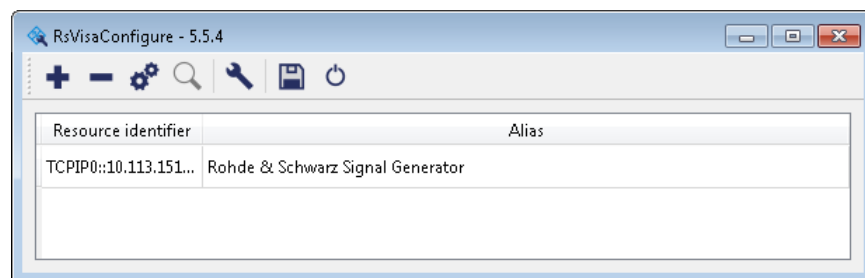

- d) Close the dialog.  
The R&S AMU is now registered in the program and can be addressed via the resource string or alias name.

9. In the main window, select "Connect".

R&S VISA establishes the connection to the R&S AMU.

Now you can send settings to configure the instrument and receive its responses.

**Note:** If the connection cannot be set up, R&S VISA displays an error in the log view. For information on how to proceed when network failures occur, see [Chapter 9.5, "Resolving Network Connection Failures"](#), on page 680.

For further information on the functions to read and write to an open session, as well as the utility applications the software provides, see the R&S VISA User Manual.

### Starting a remote control over LAN (using VXI-11)

To set the instrument to remote control, you can use the addressed command `&GTR`, or send any command from the controller.

1. Start the R&S VISA Tester and establish the connection to the R&S AMU, see ["Configuring the controller"](#) on page 392.

- In the R&S VISA "Basics" tab, enter a SCPI command, e.g. "\*IDN?" and confirm with "Query".

The instrument is switched to remote control when it receives a command from the controller.

- Select "Read" to obtain the instrument response.

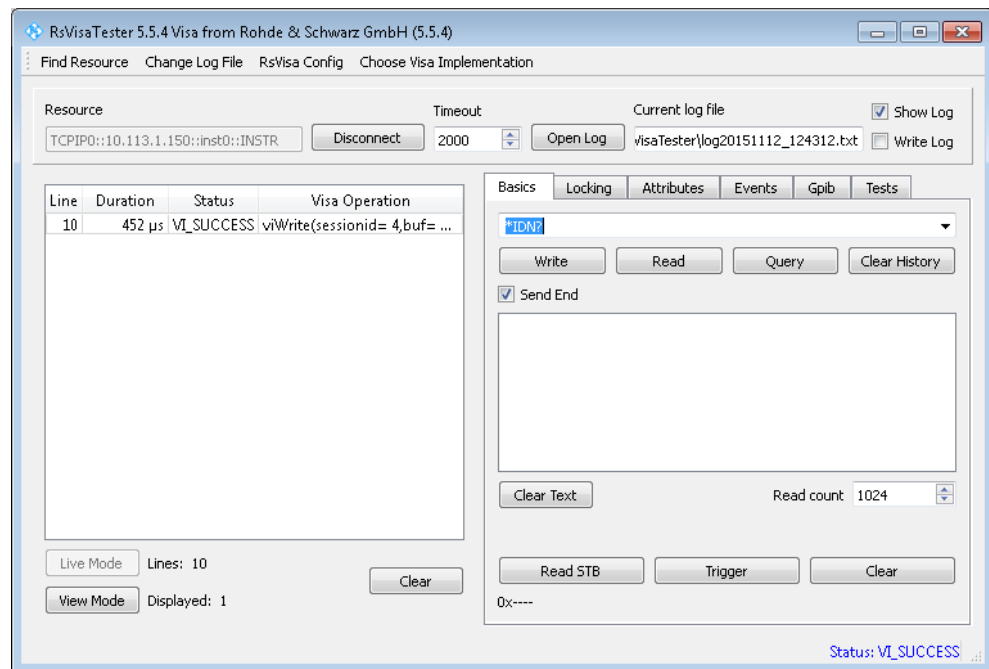

**Tip:** If the "Show Log" checkbox is checked R&S VISA displays each VISA function call in the log-view on the left. If you check the "Write Log" checkbox the log-view entry is written to the log file as well. You can operate the log-view in two modes: the "Live Mode" shows only the most recent messages whereas the "View Mode" allows you to scroll the history.

- To set, e.g. the frequency, enter `SOUR1:FREQ 4 GHz` and select "Write". To check the performed setting, `SOUR1:FREQ?` and select "Read". The instrument response is `4000000000`, i.e. the frequency is returned in Hz.

While remote control is active, the "Remote" icon in the status bar indicates that the instrument is in remote control mode. The operation via the front panel or via mouse and keyboard are locked, allowing a remote control program to be performed without interruption.

On the display, keys and entry fields are grayed out and cannot be activated or modified, but you can still open dialogs, for example to verify settings.

- To disable the access to the dialogs, use the command `SYST:KLOC ON`.
- To prevent unintentional return to manual operation, use the command `&LLO`. See also [Chapter 6.1.3.4, "LAN Interface Messages"](#), on page 386. The instrument switches to "Remote LLO" state. The LOCAL key is disabled.

7. To enable the LOCAL key, use the command `&GTR`.
8. To return to manual operation, see [Chapter 6.2.2, "Returning to Manual Operation"](#), on page 390.

**Tip:** Switching from manual operation to remote control and vice versa does not affect the other instrument settings.

### 6.2.3.3 Remote Control over LAN using Socket Communication

This chapter provides an example on how to establish a remote control connection over telnet protocol and a simple sockets-based program example that can be further developed.

#### Setting up a Telnet Connection

To control the software, only a telnet program is required. The telnet program is part of every operating system.

1. To establish a Telnet connection with the R&S AMU, start the telnet program.
2. Enter the access string to connect to the instrument and confirm with ENTER. The access string is composed of the open command short form) and the socket address. The socket address is a combination of the IP address or the host name of the R&S AMU and the number of the port configured for remote-control via telnet. The R&S AMU uses the port number 5025 for remote connection via Telnet. Example: `o 10.113.1.150 5025`

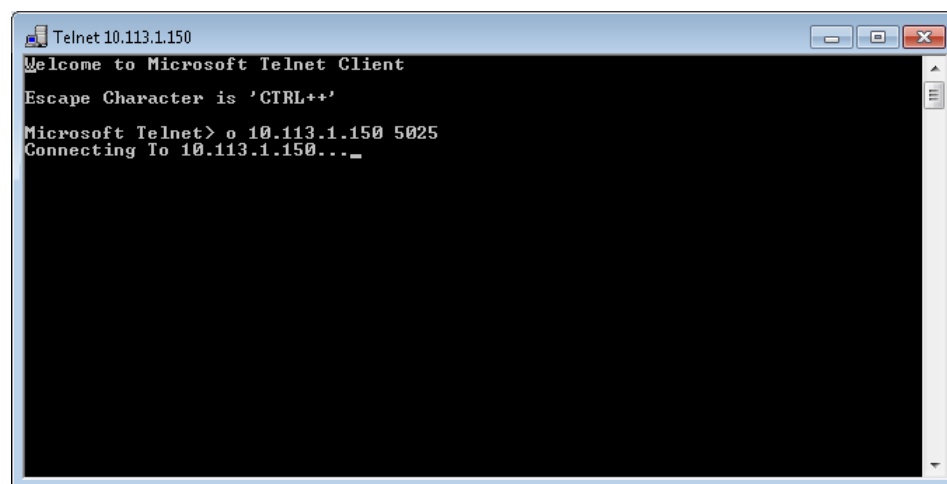

The connection to the instrument is set up and you can send remote-control commands.

3. Even if the cursor is not visible on the screen, enter blind a remote-control command and confirm with "Enter".

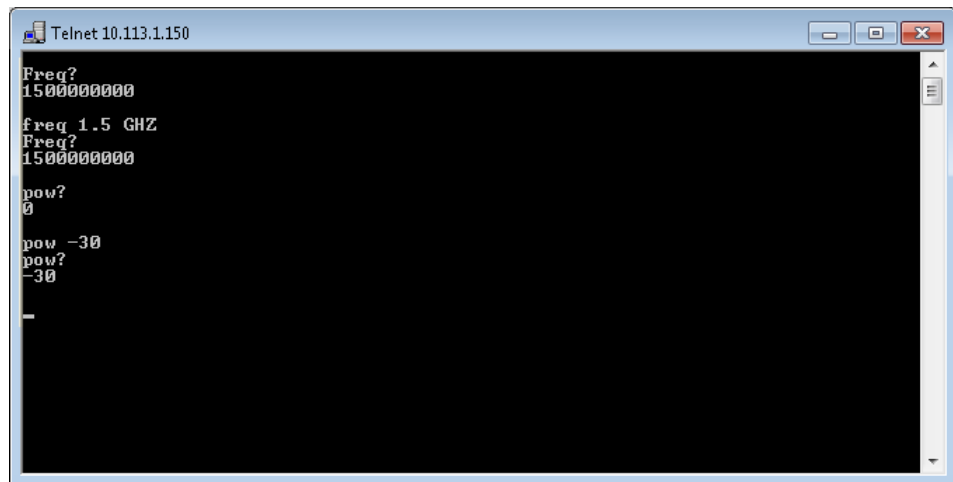
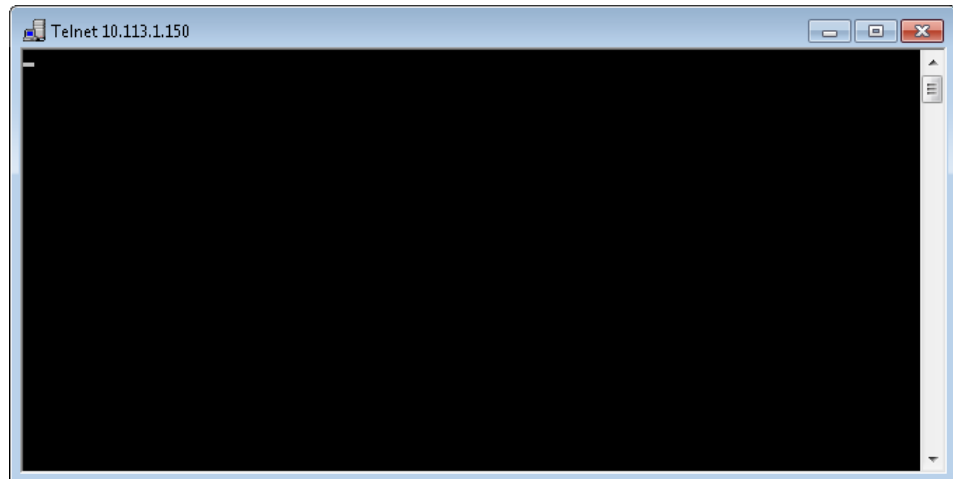

After the first remote-control command has been sent, the instrument is in the "REMOTE" state, i.e. instrument control from the front panel or via mouse and keyboard is disabled and "REMOTE" is displayed in the status line.

### TcpClient program examples

The following program example shows a simple TcpClient class that is intended to explain on how to get started with programming of sockets.

The example sets up a socket communication to R&S AMU and opens a simple user interface, very similar to the telnet, which allows input of commands. To enable real automation, further development of the program is required.

#### TcpClient.h

```

#include <string>
using namespace std;

//defines structs for socket handling
#ifndef LINUX
#include "Winsock2.h"
  
```

```

#else
    #include <netinet/in.h>
#endif

typedef struct sockaddr_in SockAddrStruct;
typedef struct hostent HostInfoStruct;
class TcpClient
{
public:
    TcpClient();
    ~TcpClient();
    void connectToServer( string &hostname, int port );
    void disconnect( );
    void transmit( string &txString );
    void receive( string &rxString );
    string getCurrentHostName( ) const;
    int getCurrentPort( ) const;
private:
    string currentHostName;
    int currentPort;
    int currentSocketDescr;
    SockAddrStruct serverAddress;
    HostInfoStruct * currentHostInfo;
    bool clientIsConnected;
    int receiveBufferSize;
};

```

### TcpClient.cpp

```

#ifdef LINUX
    #include <netdb.h>
    #include <unistd.h>
#endif

#include "TcpClient.h"
TcpClient::TcpClient()
: currentHostName( "" )
, currentPort( 0 )
, currentSocketDescr( 0 )
, serverAddress ( )
, currentHostInfo( NULL )
, clientIsConnected( false )
, receiveBufferSize( 1024 )
{}
TcpClient::~~TcpClient()
{
    currentHostInfo = NULL;
}
void TcpClient::connectToServer( string &hostname, int port )
{

```

```

currentHostInfo = gethostbyname( hostname.c_str( ) );
if( currentHostInfo == NULL )
{
#ifdef LINUX
int error = WSAGetLastError();
switch (error)
{
case WSANOTINITIALISED: throw string(" A successful case WSStartup
call must occur before using this function."); break;
case WSAENETDOWN: throw string
(" The network subsystem has failed."); break;
case WSAHOST_NOT_FOUND: throw string
(" Authoritative answer host not found."); break;
case WSATRY_AGAIN: throw string
(" Nonauthoritative host not found, or server failure."); break;
case WSANO_RECOVERY: throw string
(" A nonrecoverable error occurred."); break;
case WSANO_DATA: throw string
(" Valid name, no data record of requested type."); break;
case WSAEINPROGRESS: throw string(" A blocking Windows Sockets 1.1 call
is in progress, or the service provider is still processing a callback function.");
break;
case WSAEFAULT: throw string
(" The name parameter is not a valid part of the user address space."); break;
case WSAEINTR: throw string
(" A blocking Windows Socket 1.1 call was canceled through case
WSACancelBlockingCall."); break;
}
#endif

currentHostName = "";
currentPort = 0;
currentHostInfo = NULL;
clientIsConnected = false;
throw string("error connecting host\n" );
}
else
{
currentHostName = hostname;
currentPort = port;
currentSocketDescr = socket(AF_INET, SOCK_STREAM, 0);
if( currentSocketDescr == 0 )
{
currentHostName = "";
currentPort = 0;
currentHostInfo = NULL;
clientIsConnected = false;
throw string("can't create socket\n" );
}
serverAddress.sin_family = currentHostInfo->h_addrtype;

```



```

        serverAddress.sin_port = htons( currentPort );
        memcpy( (char *) &serverAddress.sin_addr.s_addr, currentHostInfo->
h_addr_list[0], currentHostInfo->h_length );
        if( connect( currentSocketDescr, ( struct sockaddr *) &serverAddress,
sizeof(serverAddress) ) < 0 )
        {
            throw string("can't connect server\n" );
        }
        clientIsConnected = true;
    }
}
void TcpClient::disconnect( )
{
    if( clientIsConnected )
    {
#ifdef LINUX
        closesocket( currentSocketDescr );
#else
        close( currentSocketDescr );
#endif
    }
    currentSocketDescr = 0;
    currentHostName = "";
    currentPort = 0;
    currentHostInfo = NULL;
    clientIsConnected = false;
}
void TcpClient::transmit( string &txString )
{
    if( !clientIsConnected )
    {
        throw string("connection must be established before any data can be sent\n");
    }
    char * transmitBuffer = new char[txString.length() +1];
    memcpy( transmitBuffer, txString.c_str(), txString.length() );
    transmitBuffer[txString.length()] = '\n'; //newline is needed!
    if( send( currentSocketDescr, transmitBuffer, txString.length() + 1, 0 ) < 0 )
    {
        throw string("can't transmit data\n");
    }
    delete [] transmitBuffer;
}
void TcpClient::receive( string &rxString )
{
    if( !clientIsConnected )
    {
        throw string("connection must be established before any data can be received\n");
    }
    char * receiveBuffer = new char[receiveBufferSize];
    memset( receiveBuffer, 0, receiveBufferSize );

```

```

bool receiving = true;
while( receiving )
{
    int receivedByteCount = recv( currentSocketDescr, receiveBuffer,
        receiveBufferSize, 0 );
    if( receivedByteCount < 0 )
    {
        throw string("error while receiving data\n");
    }
    rxString += string( receiveBuffer );
    receiving = ( receivedByteCount == receiveBufferSize );
}
delete [] receiveBuffer;
}
string TcpClient::getCurrentHostName( ) const
{
    return currentHostName;
}
int TcpClient::getCurrentPort( ) const
{
    return currentPort;
}

```

### TelnetClient.cpp

```

//TelnetClient.cpp: Defines the entry point for the console application.//

#include <iostream>
#include "TcpClient.h"
void printUsage()
{
    cout<<"usage: EthernetRawCommand <server-ip> [scpi-command]"<<endl;
}
int main( int argc, char *argv[] )
{
    int errorCode = 0; //no error
    bool useSingleCommand = false;
    string singleCommand = "";
    string hostname = "";
    int port = 5025;
    string input = "";
    TcpClient client;
    switch( argc )
    {
        case 3:
            useSingleCommand = true;
            singleCommand = argv[2];
        case 2:
            hostname = argv[1];
            break;
    }
}

```

```

default:
    printUsage();
    getchar();
    return(-1);
}
try
{
#ifdef LINUX
    WORD wVersionRequested = MAKEWORD( 2, 2 );
    WSADATA wsaData;
    int err = WSASStartup( wVersionRequested, &wsaData );
    if ( err != 0 )
    {
        throw string ("Could not find a usable WinSock DLL.");
    }
#endif
    client.connectToServer( hostname, port );
    bool terminate = false;
    while( !terminate )
    {
        char buffer[1024];
        if( useSingleCommand )
        {
            input = singleCommand; //send string
        }
        else
        {
            cout <<">";
            cin.getline( buffer, 1024 );
            input = buffer;
            if( input == "end" )
            {
                terminate = true;
            }
        }
        if( !terminate)
        {
            client.transmit( input ); //send string
            int qPos = input.find( "?", 0 );
            //receive string only when needed
            if( qPos > 0 )
            {
                string rcStr = "";
                client.receive( rcStr );
                cout << rcStr;
            }
        }
        if( useSingleCommand )
        {
            terminate = true;
        }
    }
}

```

```

    }
  }
} catch( const string errorString )
{
  cout<<errorString<<endl<<endl;
  cout<<"Press Enter to exit"<<endl;
  getchar();
}
client.disconnect( );
return errorCode;
}

```

## 6.3 SCPI Command Structure

SCPI commands consist of a so-called header and, in most cases, one or more parameters. The header and the parameters are separated by a "white space" (ASCII code 0 to 9, 11 to 32 decimal, e.g. blank). The headers may consist of several mnemonics (keywords). Queries are formed by appending a question mark directly to the header.

The commands can be either device-specific or device-independent (common commands). Common and device-specific commands differ in their syntax.

### 6.3.1 Syntax for Common Commands

Common (=device-independent) commands consist of a header preceded by an asterisk (\*) and possibly one or more parameters.

#### Examples:

*RST	RESET	Resets the instrument.
*ESE	EVENT STATUS ENABLE	Sets the bits of the event status enable registers.
*ESR?	EVENT STATUS QUERY	Queries the contents of the event status register.
*IDN?	IDENTIFICATION QUERY	Queries the instrument identification string.

### 6.3.2 Syntax for Device-Specific Commands



Not all commands used in the following examples are necessarily implemented in the instrument.

For demonstration purposes only, assume the existence of the following commands for this section:

- `DISPlay[:WINDow<1...4>]:MAXimize <Boolean>`
- `FORMat:READings:DATA <type>[,<length>]`
- `HCOpy:DEvice:COLor <Boolean>`
- `HCOpy:DEvice:CMAP:COLor:RGB <red>,<green>,<blue>`
- `HCOpy[:IMMediate]`
- `HCOpy:ITEM:ALL`
- `HCOpy:ITEM:LABel <string>`
- `HCOpy:PAGE:DIMensions:QUADrant [<N>]`
- `HCOpy:PAGE:ORientation LANDscape | PORTrait`
- `HCOpy:PAGE:SCALE <numeric value>`
- `MMEMory:COpy <file_source>,<file_destination>`
- `SENSE:BANDwidth|BWIDth[:RESolution] <numeric_value>`
- `SENSe:FREQuency:STOP <numeric value>`
- `SENSe:LIST:FREQuency <numeric_value>{,<numeric_value>}`

#### Long and short form

The mnemonics feature a long form and a short form. The short form is marked by upper case letters, the long form corresponds to the complete word. Either the short form or the long form can be entered; other abbreviations are not permitted.

#### Example:

`HCOpy:DEvice:COLor ON` is equivalent to `HCOP:DEV:COL ON`.



#### Case-insensitivity

Upper case and lower case notation only serves to distinguish the two forms in the manual, the instrument itself is case-insensitive.

#### Numeric suffixes

If a command can be applied to multiple instances of an object, e.g. specific channels or sources, the required instances can be specified by a suffix added to the command. Numeric suffixes are indicated by angular brackets (<1...4>, <n>, <i>) and are replaced by a single value in the command. Entries without a suffix are interpreted as having the suffix 1.

**Example:**

Definition: `HCOPY:PAGE:DIMensions:QUADrant [<N>]`

Command: `HCOP:PAGE:DIM:QUAD2`

This command refers to the quadrant 2.

**Different numbering in remote control**

For remote control, the suffix may differ from the number of the corresponding selection used in manual operation. SCPI prescribes that suffix counting starts with 1. Suffix 1 is the default state and used when no specific suffix is specified.

Some standards define a fixed numbering, starting with 0. If the numbering differs in manual operation and remote control, it is indicated for the corresponding command.

**Optional mnemonics**

Some command systems permit certain mnemonics to be inserted into the header or omitted. These mnemonics are marked by square brackets in the description. The instrument must recognize the long command to comply with the SCPI standard. Some commands are considerably shortened by these optional mnemonics.

**Example:**

Definition: `HCOPY[:IMMEDIATE]`

Command: `HCOP:IMM` is equivalent to `HCOP`

**Optional mnemonics with numeric suffixes**

Do not omit an optional mnemonic if it includes a numeric suffix that is relevant for the effect of the command.

**Example:**

Definition: `DISPlay[:WINDow<1...4>]:MAXimize <Boolean>`

Command: `DISP:MAX ON` refers to window 1.

In order to refer to a window other than 1, you must include the optional `WINDow` parameter with the suffix for the required window.

`DISP:WIND2:MAX ON` refers to window 2.

**Parameters**

Parameters must be separated from the header by a "white space". If several parameters are specified in a command, they are separated by a comma (.). For a description of the parameter types, refer to [Chapter 6.3.3, "SCPI Parameters"](#), on page 407.

**Example:**

Definition: `HCOPY:DEvice:CMAP:COLor:RGB <red>, <green>, <blue>`

Command: `HCOP:DEV:CMAP:COL:RGB 3, 32, 44`

## Special characters

	<p><b>Parameters</b></p> <p>A vertical stroke in parameter definitions indicates alternative possibilities in the sense of "or". The effect of the command differs, depending on which parameter is used.</p> <p><b>Example:</b></p> <pre>Definition:HCOPy:PAGE:ORIENTATION LANDscape   PORTRait</pre> <p>Command <code>HCOP:PAGE:ORI LAND</code> specifies landscape orientation</p> <p>Command <code>HCOP:PAGE:ORI PORT</code> specifies portrait orientation</p> <p><b>Mnemonics</b></p> <p>A selection of mnemonics with an identical effect exists for several commands. These mnemonics are indicated in the same line; they are separated by a vertical stroke. Only one of these mnemonics needs to be included in the header of the command. The effect of the command is independent of which of the mnemonics is used.</p> <p><b>Example:</b></p> <pre>DefinitionSENSE:BANDwidth BWIDTH[:RESolution] &lt;numeric_value&gt;</pre> <p>The two following commands with identical meaning can be created:</p> <pre>SENS:BAND:RES 1 SENS:BWID:RES 1</pre>
[]	<p>Mnemonics in square brackets are optional and may be inserted into the header or omitted.</p> <p><b>Example:</b> <code>HCOPy[:IMMEDIATE]</code></p> <p><code>HCOP:IMM</code> is equivalent to <code>HCOP</code></p>
{ }	<p>Parameters in curly brackets are optional and can be inserted once or several times, or omitted.</p> <p><b>Example:</b> <code>SENSe:LIST:FREQuency &lt;numeric_value&gt;{,&lt;numeric_value&gt;}</code></p> <p>The following are valid commands:</p> <pre>SENS:LIST:FREQ 10 SENS:LIST:FREQ 10,20 SENS:LIST:FREQ 10,20,30,40</pre>

### 6.3.3 SCPI Parameters

Many commands are supplemented by a parameter or a list of parameters. The parameters must be separated from the header by a "white space" (ASCII code 0 to 9, 11 to 32 decimal, e.g. blank). Allowed parameters are:

- Numeric values
- Special numeric values
- Boolean parameters
- Text
- Character strings
- Block data

The parameters required for each command and the allowed range of values are specified in the command description.

### Numeric values

Numeric values can be entered in any form, i.e. with sign, decimal point and exponent. Values exceeding the resolution of the instrument are rounded up or down. The mantissa may comprise up to 255 characters, the exponent must lie inside the value range -32000 to 32000. The exponent is introduced by an "E" or "e". Entry of the exponent alone is not allowed. In the case of physical quantities, the unit can be entered.

Allowed unit prefixes are G (giga), MA (mega), MOHM and MHZ (also allowed), K (kilo), M (milli), U (micro) and N (nano). If the unit is missing, the basic unit is used.

**Example:** `SENS:FREQ:STOP 1.5GHz = SENS:FREQ:STOP 1.5E9`

### Units

For physical quantities, the unit can be entered. Allowed unit prefixes are:

- G (giga)
- MA (mega), MOHM, MHZ
- K (kilo)
- M (milli)
- U (micro)
- N (nano)

If the unit is missing, the basic unit is used.

### Example:

`SENSe:FREQ:STOP 1.5GHz = SENSe:FREQ:STOP 1.5E9`

Some settings allow relative values to be stated in percent. According to SCPI, this unit is represented by the `PCT` string.

### Example:

`HCOP:PAGE:SCAL 90PCT`

### Special numeric values

The texts listed below are interpreted as special numeric values. In the case of a query, the numeric value is provided.

- **MIN/MAX**  
MINimum and MAXimum denote the minimum and maximum value.
- **DEF**  
DEFault denotes a preset value which has been stored in the EPROM. This value conforms to the default setting, as it is called by the `*RST` command.
- **UP/DOWN**  
UP, DOWN increases or reduces the numeric value by one step. The step width can be specified via an allocated step command for each parameter which can be set via UP, DOWN.
- **INF/NINF**



INFINITY, Negative INFINITY (NINF) represent the numeric values 9.9E37 or -9.9E37, respectively. INF and NINF are only sent as instrument responses.

- **NAN**

Not A Number (NAN) represents the value 9.91E37. NAN is only sent as a instrument response. This value is not defined. Possible causes are the division of zero by zero, the subtraction of infinite from infinite and the representation of missing values.

**Example:**

Setting command: `SENSe:LIST:FREQ MAXimum`

Query: `SENS:LIST:FREQ?`, Response: `3.5E9`



**Queries for special numeric values**

The numeric values associated to `MAXimum`/`MINimum`/`DEFault` can be queried by adding the corresponding mnemonics to the command. They must be entered following the quotation mark.

Example: `SENSe:LIST:FREQ? MAXimum`

Returns the maximum numeric value as a result.

**Boolean Parameters**

Boolean parameters represent two states. The "ON" state (logically true) is represented by "ON" or a numeric value 1. The "OFF" state (logically untrue) is represented by "OFF" or the numeric value 0. The numeric values are provided as the response for a query.

**Example:**

Setting command: `HCOpy:DEV:COL ON`

Query: `HCOpy:DEV:COL?`

Response: `1`

**Text parameters**

Text parameters observe the syntactic rules for mnemonics, i.e. they can be entered using a short or long form. Like any parameter, they have to be separated from the header by a white space. In the case of a query, the short form of the text is provided.

**Example:**

Setting command: `HCOpy:PAGE:ORientation LANDscape`

Query: `HCOp:PAGE:ORI?`

Response: `LAND`

**Character strings**

Strings must always be entered in quotation marks (' or ").

**Example:**

```
HCOP:ITEM:LABel "Test1" or HCOP:ITEM:LABel 'Test1'
```

**Block data**

Block data is a format which is suitable for the transmission of large amounts of data. A command using a block data parameter has the following structure:

**Example:**

```
FORMat:READings:DATA #45168xxxxxxxx
```

The ASCII character # introduces the data block. The next number indicates how many of the following digits describe the length of the data block. In the example the 4 following digits indicate the length to be 5168 bytes. The data bytes follow. During the transmission of these data bytes all end or other control signs are ignored until all bytes are transmitted.

#0 specifies a data block of indefinite length. The use of the indefinite format requires a `NL^END` message to terminate the data block. This format is useful when the length of the transmission is not known or if speed or other considerations prevent segmentation of the data into blocks of definite length.

### 6.3.4 Overview of Syntax Elements

The following table provides an overview of the syntax elements:

:	The colon separates the mnemonics of a command. In a command line the separating semicolon marks the uppermost command level.
;	The semicolon separates two commands of a command line. It does not alter the path.
,	The comma separates several parameters of a command.
?	The question mark forms a query.
*	The asterisk marks a common command.
''	Quotation marks introduce a string and terminate it (both single and double quotation marks are possible).
#	The hash symbol introduces binary, octal, hexadecimal and block data. <ul style="list-style-type: none"> <li>• Binary: #B10110</li> <li>• Octal: #O7612</li> <li>• Hexa: #HF3A7</li> <li>• Block: #21312</li> </ul>
	A "white space" (ASCII-Code 0 to 9, 11 to 32 decimal, e.g. blank) separates the header from the parameters.

### 6.3.5 Structure of a command line

A command line may consist of one or several commands. It is terminated by one of the following:

- a <New Line>
- a <New Line> with EOI
- an EOI together with the last data byte

Several commands in a command line must be separated by a semicolon ";". If the next command belongs to a different command system, the semicolon is followed by a colon.

**Example:**

```
MMEM:COPY "Test1", "MeasurementXY";:HCOP:ITEM ALL
```

This command line contains two commands. The first command belongs to the MMEM system, the second command belongs to the HCOP system.

If the successive commands belong to the same system, having one or several levels in common, the command line can be abbreviated. To this end, the second command after the semicolon starts with the level that lies below the common levels. The colon following the semicolon must be omitted in this case.

**Example:**

```
HCOP:ITEM ALL;:HCOP:IMM
```

This command line contains two commands. Both commands are part of the HCOP command system, i.e. they have one level in common.

When abbreviating the command line, the second command begins with the level below HCOP. The colon after the semicolon is omitted. The abbreviated form of the command line reads as follows:

```
HCOP:ITEM ALL;IMM
```

A new command line always begins with the complete path.

**Example:**

```
HCOP:ITEM ALL
```

```
HCOP:IMM
```

### 6.3.6 Responses to Queries

A query is defined for each setting command unless explicitly specified otherwise. It is formed by adding a question mark to the associated setting command. According to SCPI, the responses to queries are partly subject to stricter rules than in standard IEEE 488.2.

- The requested parameter is transmitted without a header.  
**Example:** `HCOP:PAGE:ORI?`, **Response:** `LAND`
- Maximum values, minimum values and all other quantities that are requested via a special text parameter are returned as numeric values.  
**Example:** `SENSe:FREQuency:STOP? MAX`, **Response:** `3.5E9`

- Numeric values are output without a unit. Physical quantities are referred to the basic units or to the units set using the `Unit` command. The response `3.5E9` in the previous example stands for 3.5 GHz.
- Truth values (Boolean values) are returned as 0 (for OFF) and 1 (for ON).

**Example:**

Setting command: `HCOPY:DEV:COL ON`

Query: `HCOPY:DEV:COL?`

Response: 1

- Text (character data) is returned in a short form.

**Example:**

Setting command: `HCOPY:PAGE:ORIENTATION LANDscape`

Query: `HCOP:PAGE:ORI?`

Response: LAND

## 6.4 Command Sequence and Synchronization

IEEE 488.2 defines a distinction between overlapped and sequential commands:

- A sequential command is one which finishes executing before the next command starts executing. Commands that are processed quickly are usually implemented as sequential commands. Sequential commands are not implemented in the instrument, however the execution time of most commands is so short that they act as sequential commands when sent in different command lines.
- An overlapping command is one which does not automatically finish executing before the next command starts executing. Usually, overlapping commands take longer to process and allow the program to do other tasks while being executed. If overlapping commands do have to be executed in a defined order, e.g. in order to avoid wrong measurement results, they must be serviced sequentially. This is called synchronization between the controller and the instrument.

Setting commands within one command line, even though they may be implemented as sequential commands, are not necessarily serviced in the order in which they have been received. In order to make sure that commands are actually carried out in a certain order, each command must be sent in a separate command line.

**Example: Commands and queries in one message**

The response to a query combined in a program message with commands that affect the queried value is not predictable.

The following commands always return the specified result:

```
:FREQ:STAR 1GHZ;SPAN 100 :FREQ:STAR?
```

Result:

```
1000000000 (1 GHz)
```

Whereas the result for the following commands is not specified by SCPI:

```
:FREQ:STAR 1GHz;STAR?;SPAN 1000000
```

The result could be the value of `START` before the command was sent since the instrument might defer executing the individual commands until a program message terminator is received. The result could also be 1 GHz if the instrument executes commands as they are received.



As a general rule, send commands and queries in different program messages.

**Example: Overlapping command with \*OPC**

The instrument implements `INITiate[:IMMEDIATE]` as an overlapped command. Assuming that `INITiate[:IMMEDIATE]` takes longer to execute than `*OPC`, sending the following command sequence results in initiating a sweep and, after some time, setting the `OPC` bit in the `ESR`:

```
INIT; *OPC.
```

Sending the following commands still initiates a sweep:

```
INIT; *OPC; *CLS
```

However, since the operation is still pending when the instrument executes `*CLS`, forcing it into the "Operation Complete Command Idle" State (OCIS), `*OPC` is effectively skipped. The `OPC` bit is not set until the instrument executes another `*OPC` command.

**Example: Overlapped command followed by non-conflicting commands**

Suppose that the instrument is switched on to provide a real time test signal that requires some calculation time. At the same time some settings for the configuration of a different signal are made which do not interact with the generated signal (e.g. the signal may be used later on). The signal generation and the signal configuration are independent from each other, so none of the following overlapped commands needs to be synchronized:

```
SOUR:BB:3GPP:STAT ON
```

```
SOUR:BB:GSM:FORM FSK2
```

**Example: Overlapped command followed by conflicting commands**

Suppose that the generator is switched on to provide a real time test signal that requires some calculation time. This signal is to be added to a waveform from the second baseband generator. In this case the application program must ensure that the real signal is actually available in the added signal before further action is started. This involves an appropriate synchronization technique for the first command (the following sequence assumes an appropriate routing):

```
SOUR:BB:3GPP:STAT ON
```

The instrument waits until command has finished.

```
SOUR2:BB:GSM:STAT ON
```

Depending on the selected synchronization techniques, non-conflicting commands can be executed while waiting until the synchronized overlapped command has finished.

**6.4.1 Preventing Overlapping Execution**

To prevent an overlapping execution of commands, one of the commands \*OPC, \*OPC? or \*WAI can be used. All three commands cause a certain action only to be carried out after the hardware has been set. By suitable programming, the controller can be forced to wait for the corresponding action to occur.

**Table 6-2: Synchronization using \*OPC, \*OPC? and \*WAI**

Command	Action	Programming the controller
*OPC	Sets the Operation Complete bit in the ESR after all previous commands have been executed.	<ul style="list-style-type: none"> <li>Setting bit 0 in the ESE</li> <li>Setting bit 5 in the SRE</li> <li>Waiting for service request (SRQ)</li> </ul>
*OPC?	Stops command processing until 1 is returned. This is only the case after the Operation Complete bit has been set in the ESR. This bit indicates that the previous setting has been completed.	Sending *OPC? directly after the command whose processing should be terminated before other commands can be executed.
*WAI	Stops further command processing until all commands sent before *WAI have been executed.	Sending *WAI directly after the command whose processing should be terminated before other commands are executed.

Command synchronization using \*WAI or \*OPC? appended to an overlapped command is a good choice if the overlapped command takes only little time to process. The two synchronization techniques simply block overlapped execution of the command.

For time consuming overlapped commands it is usually desirable to allow the controller or the instrument to do other useful work while waiting for command execution. Use one of the following methods:

**\*OPC with a service request**

1. Set the OPC mask bit (bit no. 0) in the ESE: \*ESE 1
2. Set bit no. 5 in the SRE: \*SRE 32 to enable ESB service request.
3. Send the overlapped command with \*OPC

4. Wait for a service request

The service request indicates that the overlapped command has finished.

#### **\*OPC? with a service request**

1. Set bit no. 4 in the SRE: \*SRE 16 to enable MAV service request.
2. Send the overlapped command with \*OPC?
3. Wait for a service request

The service request indicates that the overlapped command has finished.

#### **Event Status Register (ESE)**

1. Set the OPC mask bit (bit no. 0) in the ESE: \*ESE 1
2. Send the overlapped command without \*OPC, \*OPC? or \*WAI
3. Poll the operation complete state periodically (by means of a timer) using the sequence: \*OPC; \*ESR?

A return value (LSB) of 1 indicates that the overlapped command has finished.

#### **\*OPC? with short timeout**

1. Send the overlapped command without \*OPC, \*OPC? or \*WAI
2. Poll the operation complete state periodically (by means of a timer) using the sequence: <short timeout>; \*OPC?
3. A return value (LSB) of 1 indicates that the overlapped command has finished. In case of a timeout, the operation is ongoing.
4. Reset timeout to former value
5. Clear the error queue with `SYStem:ERROR?` to remove the "-410, Query interrupted" entries.

#### **Using several threads in the controller application**

As an alternative, provided the programming environment of the controller application supports threads, separate threads can be used for the application GUI and for controlling the instrument(s) via SCPI.

A thread waiting for a \*OPC? thus will not block the GUI or the communication with other instruments.

## **6.5 Status Reporting System**

The status reporting system stores all information on the current operating state of the instrument, and on errors which have occurred. This information is stored in the status registers and in the error queue.

You can query both with the commands of the [STATus Subsystem](#).

### 6.5.1 Hierarchy of the Status Registers

The [Figure 6-1](#) shows the hierarchical structure of information in the status registers (ascending from left to right).

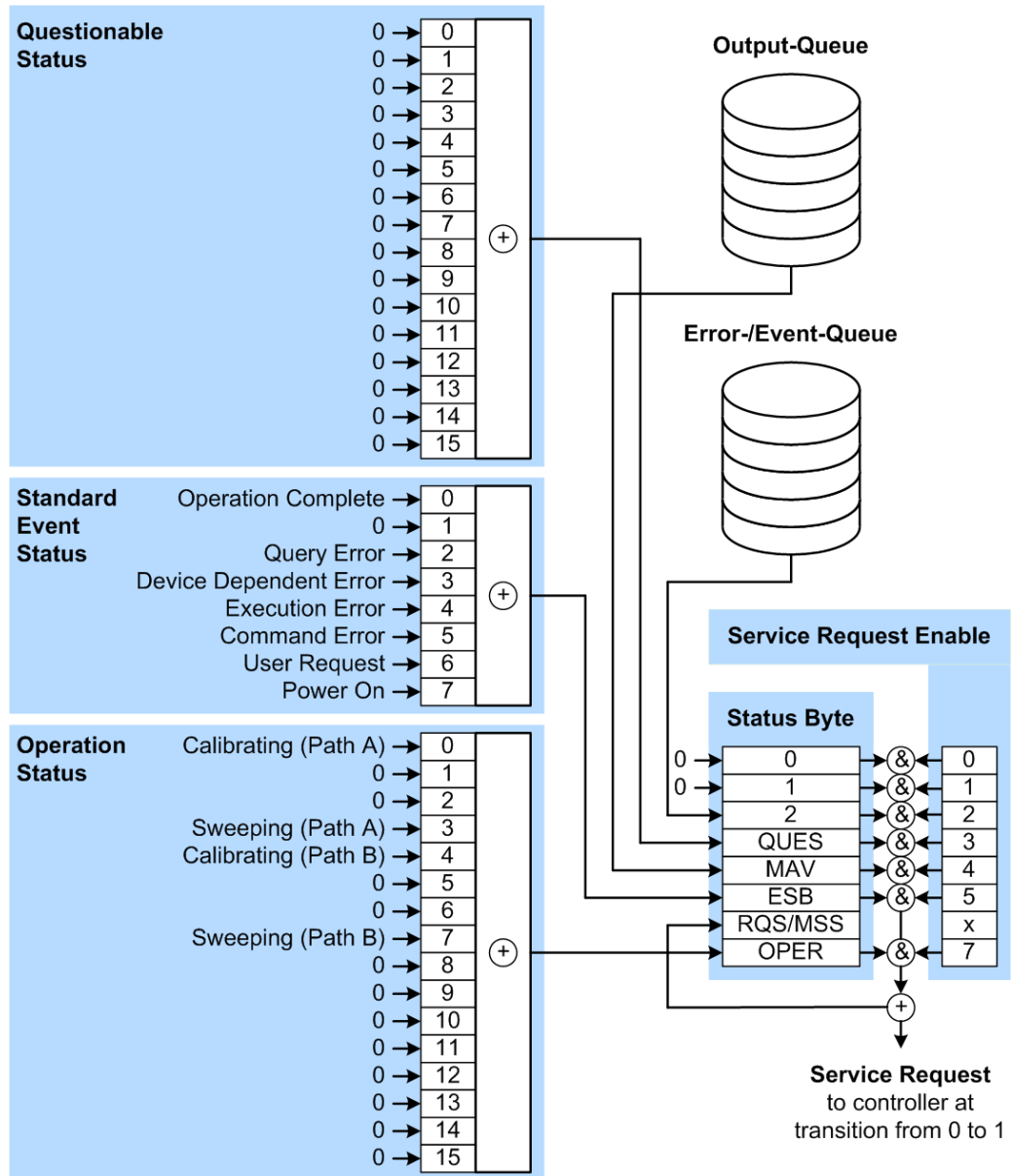

Figure 6-1: Graphical overview of the status registers hierarchy

- OPER = Operation Status Summary Bit
- RQS/MSS = Service Request Generation
- ESB = Standard Event Status Summary Bit
- MAV = Message Available in Output Queue



QUES = Questionable Status Summary Bit  
 2 = Error- /Event-Queue  
 1, 0 = not used

**Note:** This legend explains the abbreviations to the Status Byte Register.

The R&S AMU uses the following status registers:

- **Status Byte (STB) and Service Request Enable (SRE)**, see [Chapter 6.5.3, "Status Byte \(STB\) and Service Request Enable Register \(SRE\)"](#), on page 419.
- **Standard Event Status**, i.e. the Event status Register (ESR) and the Event Status Enable (ESE), see [Chapter 6.5.4, "Event Status Register \(ESR\) and Event Status Enable Register \(ESE\)"](#), on page 420.
- **Questionable Status and Operation Status**, the (SCPI status registers, see [Chapter 6.5.2, "Structure of a SCPI Status Register"](#), on page 417, [Chapter 6.5.5, "Questionable Status Register \(STATus:QUEStionable\)"](#), on page 421 and [Chapter 6.5.6, "Operation Status Register \(STATus:OPERation\)"](#), on page 421.
- **Output-Queue**  
 The output queue contains the messages the instrument returns to the controller. It is not part of the status reporting system but determines the value of the `MAV` bit in the `STB` and thus is represented in the overview.
- **Error- /Event-Queue**  
 The error-/event-queue contains all errors and events that have occurred in the past. When reading the queue, the instrument starts with the first occurred error/ event.

All status registers have the same internal structure.



### SRE, ESE

The service request enable register `SRE` can be used as `ENABLE` part of the `STB` if the `STB` is structured according to SCPI. By analogy, the `ESE` can be used as the `ENABLE` part of the `ESR`.

## 6.5.2 Structure of a SCPI Status Register

Each standard SCPI register consists of 5 parts. Each part has a width of 16 bits and has different functions. The individual bits are independent of each other, i.e. each hardware status is assigned a bit number which is valid for all five parts. Bit 15 (the most significant bit) is set to zero for all parts. Thus the contents of the register parts can be processed by the controller as positive integers.

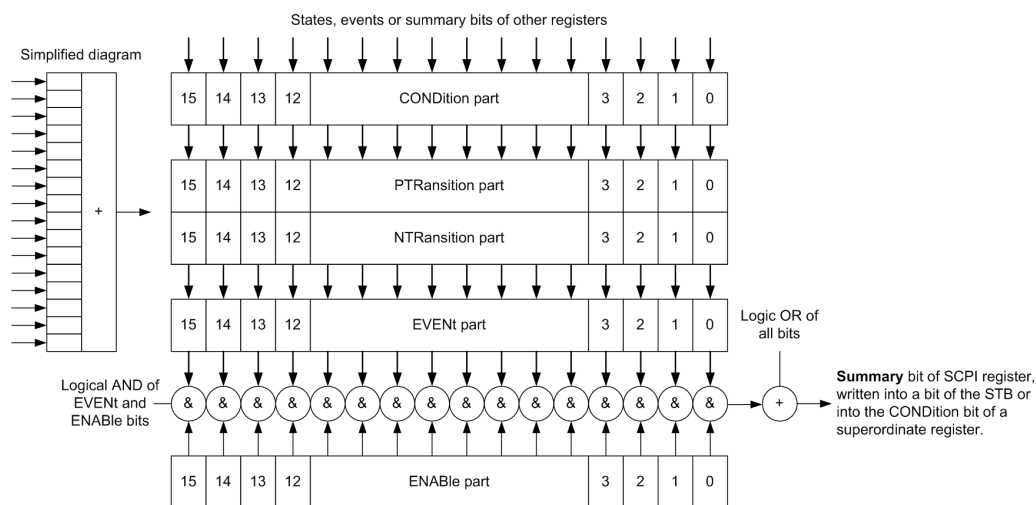

Figure 6-2: The status-register model

### Description of the five status register parts

The five parts of a SCPI register have different properties and functions:

- **CONDition**

The **CONDition** part is written into directly by the hardware or the sum bit of the next lower register. Its contents reflect the current instrument status. This register part can only be read, but not written into or cleared. Its contents are not affected by reading.

- **PTRansition / NTRansition**

The two transition register parts define which state transition of the **CONDition** part (none, 0 to 1, 1 to 0 or both) is stored in the **EVENT** part.

The **Positive-TRansition** part acts as a transition filter. When a bit of the **CONDition** part is changed from 0 to 1, the associated **PTR** bit decides whether the **EVENT** bit is set to 1.

- **PTR** bit =1: the **EVENT** bit is set.
- **PTR** bit =0: the **EVENT** bit is not set.

This part can be written into and read as required. Its contents are not affected by reading.

The **Negative-TRansition** part also acts as a transition filter. When a bit of the **CONDition** part is changed from 1 to 0, the associated **NTR** bit decides whether the **EVENT** bit is set to 1.

- **NTR** bit =1: the **EVENT** bit is set.
- **NTR** bit =0: the **EVENT** bit is not set.

This part can be written into and read as required. Its contents are not affected by reading.

- **EVENT**

The **EVENT** part indicates whether an event has occurred since the last reading, it is the "memory" of the condition part. It only indicates events passed on by the transition filters. It is permanently updated by the instrument. This part can only be

read by the user. Reading the register clears it. This part is often equated with the entire register.

- **ENABLE**

The `ENABLE` part determines whether the associated `EVENT` bit contributes to the sum bit (see below). Each bit of the `EVENT` part is "ANDed" with the associated `ENABLE` bit (symbol '&'). The results of all logical operations of this part are passed on to the sum bit via an "OR" function (symbol '+').

`ENABLE` bit = 0: the associated `EVENT` bit does not contribute to the sum bit

`ENABLE` bit = 1: if the associated `EVENT` bit is "1", the sum bit is set to "1" as well.

This part can be written into and read by the user as required. Its contents are not affected by reading.

### Sum bit

The sum bit is obtained from the `EVENT` and `ENABLE` part for each register. The result is then entered into a bit of the `CONDition` part of the higher-order register.

The instrument automatically generates the sum bit for each register. Thus an event can lead to a service request throughout all levels of the hierarchy.

## 6.5.3 Status Byte (STB) and Service Request Enable Register (SRE)

The `Status Byte` (STB) is already defined in IEEE 488.2. It provides a rough overview of the instrument status by collecting the pieces of information of the lower registers. A special feature is that bit 6 acts as the sum bit of the remaining bits of the status byte.

The STB is read using the command `*STB?` or a serial poll.

The `Status Byte` (STB) is linked to the `Service Request Enable` (SRE) register. Each bit of the STB is assigned a bit in the SRE. Bit 6 of the SRE is ignored. If a bit is set in the SRE and the associated bit in the STB changes from 0 to 1, a service request (SRQ) is generated. The SRE can be set using the command `*SRE` and read using the command `*SRE?`.

**Table 6-3: Meaning of the bits used in the status byte**

Bit No.	Meaning
0...1	Not used
2	Error Queue not empty The bit is set when an entry is made in the error queue. If this bit is enabled by the SRE, each entry of the error queue generates a service request. Thus an error can be recognized and specified in greater detail by polling the error queue. The poll provides an informative error message. This procedure is to be recommended since it considerably reduces the problems involved with remote control.
3	QUESTIONable status register summary bit The bit is set if an <code>EVENT</code> bit is set in the <code>QUESTIONable</code> status register and the associated <code>ENABLE</code> bit is set to 1. A set bit indicates a questionable instrument status, which can be specified in greater detail by querying the <code>STATUS:QUESTIONable</code> status register.

Bit No.	Meaning
4	MAV bit (message available) The bit is set if a message is available in the output queue which can be read. This bit can be used to enable data to be automatically read from the instrument to the controller.
5	ESB bit Sum bit of the event status register. It is set if one of the bits in the event status register is set and enabled in the event status enable register. Setting of this bit indicates a serious error which can be specified in greater detail by polling the event status register.
6	MSS bit (master status summary bit) The bit is set if the instrument triggers a service request. This is the case if one of the other bits of this registers is set together with its mask bit in the service request enable register SRE.
7	STATUS:OPERation status register summary bit The bit is set if an EVENT bit is set in the OPERATION status register and the associated ENABLE bit is set to 1. A set bit indicates that the instrument is just performing an action. The type of action can be determined by querying the STATUS:OPERation status register.

#### 6.5.4 Event Status Register (ESR) and Event Status Enable Register (ESE)

The ESR is defined in IEEE 488.2. It can be compared with the EVENT part of a SCPI register. The event status register can be read out using command \*ESR?.

The ESE corresponds to the ENABLE part of a SCPI register. If a bit is set in the ESE and the associated bit in the ESR changes from 0 to 1, the ESB bit in the STB is set. The ESE register can be set using the command \*ESE and read using the command \*ESE?.

**Table 6-4: Meaning of the bits used in the event status register**

Bit No.	Meaning
0	Operation Complete This bit is set on receipt of the command *OPC exactly when all previous commands have been executed.
1	Not used
2	Query Error This bit is set if either the controller wants to read data from the instrument without having sent a query, or if it does not fetch requested data and sends new instructions to the instrument instead. The cause is often a query which is faulty and hence cannot be executed.
3	Device-dependent Error This bit is set if a device-dependent error occurs. An error message with a number between -300 and -399 or a positive error number, which denotes the error in greater detail, is entered into the error queue.
4	Execution Error This bit is set if a received command is syntactically correct but cannot be performed for other reasons. An error message with a number between -200 and -300, which denotes the error in greater detail, is entered into the error queue.

Bit No.	Meaning
5	Command Error This bit is set if a command is received, which is undefined or syntactically incorrect. An error message with a number between -100 and -200, which denotes the error in greater detail, is entered into the error queue.
6	User Request This bit is set when the instrument is switched over to manual control.
7	Power On (supply voltage on) This bit is set on switching on the instrument.

### 6.5.5 Questionable Status Register (STATus:QUESTionable)

This register contains information on questionable instrument states. Such states may occur when the instrument is not operated in compliance with its specifications.

To read the register, use the query commands [STAT:QUEST:COND?](#) or [STAT:QUEST\[:EVEN\]?](#).

*Table 6-5: Meaning of the bits used in the questionable status register*

Bit No.	Meaning
0–15	Not used

### 6.5.6 Operation Status Register (STATus:OPERation)

This condition part contains information on the actions currently being performed by the instrument, while the event part contains information on the actions performed by the instrument since the last readout of the register.

To read the register, use the query commands [STAT:OPER:COND?](#) or [STAT:OPER\[:EVEN\]?](#).

*Table 6-6: Meaning of the bits used in the operation status register*

Bit No.	Meaning
0	Calibrating
4	The bit is set during the calibration phase.
1–2 5–6	Not used
3	Sweeping
7	This bit is set during a sweep in automatic or single mode.
8–15	Not used

## 6.5.7 Application of the Status Reporting System

The purpose of the status reporting system is to monitor the status of one or several devices in a measuring system. To do this and react appropriately, the controller must receive and evaluate the information of all devices. The following standard methods are used:

- **Service request** (SRQ) initiated by the instrument
- **Serial poll** of all devices in the bus system, initiated by the controller to find out who sent an SRQ and why
- Query of a **specific instrument status** by commands
- Query of the **error queue**

### 6.5.7.1 Service Request

Under certain circumstances, the instrument can send a service request (SRQ) to the controller. Usually this service request initiates an interrupt at the controller, to which the control program can react appropriately. An SRQ is always initiated if one or several of bits 2, 4 or 5 of the status byte are set and enabled in the SRE. Each of these bits combines the information of the error queue or the output buffer. To use the possibilities of the service request effectively, all bits should be set to "1" in the enable registers SRE and ESE.

#### Example:

Use command `*OPC` to generate an SRQ .

`*ESE 1` - set bit 0 of ESE (Operation Complete)

`*SRE 32` - set bit 5 of SRE (ESB).

After its settings have been completed, the instrument generates an SRQ.

The SRQ is the only possibility for the instrument to become active on its own. Each controller program should set the instrument such that a service request is initiated in the case of malfunction. The program should react appropriately to the service request.

### 6.5.7.2 Serial Poll

In a serial poll, just as with command `*STB`, the status byte of an instrument is queried. However, the query is realized via interface messages and is thus clearly faster.

The serial poll method is defined in IEEE 488.1 and used to be the only standard possibility for different instruments to poll the status byte. The method also works for instruments which do not adhere to SCPI or IEEE 488.2.

The serial poll is mainly used to obtain a fast overview of the state of several instruments connected to the controller.

### 6.5.7.3 Query of an instrument status

Each part of any status register can be read using queries. There are two types of commands:

- The common commands `*ESR?`, `*IDN?`, `*IST?`, `*STB?` query the higher-level registers.
- The commands of the `STATus` system query the SCPI registers (`STATus:QUESTionable...`)

The returned value is always a decimal number that represents the bit pattern of the queried register. This number is evaluated by the controller program.

Queries are usually used after an SRQ in order to obtain more detailed information on the cause of the SRQ.

### 6.5.7.4 Error Queue

Each error state in the instrument leads to an entry in the error queue. The entries of the error queue are detailed plain text error messages that can be looked up in the Error Log or queried via remote control using `SYSTEM:ERROR[:NEXT]?` or `SYSTEM:ERROR:ALL?`. Each call of `SYSTEM:ERROR[:NEXT]?` provides one entry from the error queue. If no error messages are stored there any more, the instrument responds with 0, "No error".

The error queue should be queried after every SRQ in the controller program as the entries describe the cause of an error more precisely than the status registers. Especially in the test phase of a controller program the error queue should be queried regularly since faulty commands from the controller to the instrument are recorded there as well.

## 6.5.8 Reset Values of the Status Reporting System

The following table contains the different commands and events causing the status reporting system to be reset. None of the commands, except of `*RST` and `SYSTEM:PRESet` affect the functional instrument settings. In particular, `DCL` does not change the instrument settings.

**Table 6-7: Resetting the status reporting system**

Event	Switching on supply voltage Power-On-Status-Clear		DCL, SDC (Device Clear, Selected Device Clear)	*RST or SYSTEM: PRESet	STATus: PRESet	*CLS
	0	1				
Clear STB, ESR	-	Yes	-	-	-	Yes
Clear SRE, ESE	-	Yes	-	-	-	-
Clear PPE	-	Yes	-	-	-	-

Event	Switching on supply voltage		DCL, SDC  (Device Clear, Selected Device Clear)	*RST or SYSTem: PRESet	STATus: PRESet	*CLS
	Power-On-Status-Clear					
Effect	0	1				
Clear error queue	Yes	Yes	-	-	-	Yes
Clear output buffer	Yes	Yes	Yes	1)	1)	1)
Clear command processing and input buffer	Yes	Yes	Yes	-	-	-

1) The first command in a command line that immediately follows a <PROGRAM MESSAGE TERMINATOR> clears the output buffer.

## 6.6 General Programming Recommendations

### Initial instrument status before changing settings

Manual operation is designed for maximum possible operating convenience. In contrast, the priority of remote control is the "predictability" of the instrument status. Thus, when a command attempts to define incompatible settings, the command is ignored and the instrument status remains unchanged, i.e. other settings are not automatically adapted. Therefore, control programs should always define an initial instrument status (e.g. using the \*RST command) and then implement the required settings.

### Command sequence

As a general rule, send commands and queries in different program messages. Otherwise, the result of the query may vary depending on which operation is performed first (see also Preventing Overlapping Execution).

### Reacting to malfunctions

The service request is the only possibility for the instrument to become active on its own. Each controller program should instruct the instrument to initiate a service request in case of malfunction. The program should react appropriately to the service request.

### Error queues

The error queue should be queried after every service request in the controller program as the entries describe the cause of an error more precisely than the status registers. Especially in the test phase of a controller program the error queue should be queried regularly since faulty commands from the controller to the instrument are recorded there as well.



## 7 Remote Control Commands

In the following, all remote-control commands will be presented in detail with their parameters and the ranges of numerical values.

For an introduction to remote control and the status registers, refer to [Chapter 6, "Remote Control Basics"](#), on page 381.

### 7.1 Conventions used in SCPI Command Descriptions

Note the following conventions used in the remote command descriptions:

- **Command usage**  
If not specified otherwise, commands can be used both for setting and for querying parameters.  
If a command can be used for setting or querying only, or if it initiates an event, the usage is stated explicitly.
- **Parameter usage**  
If not specified otherwise, a parameter can be used to set a value and it is the result of a query.  
Parameters required only for setting are indicated as **Setting parameters**.  
Parameters required only to refine a query are indicated as **Query parameters**.  
Parameters that are only returned as the result of a query are indicated as **Return values**.
- **Conformity**  
Commands that are taken from the SCPI standard are indicated as **SCPI confirmed**. All commands used by the R&S AMU follow the SCPI syntax rules.
- **Asynchronous commands**  
A command which does not automatically finish executing before the next command starts executing (overlapping command) is indicated as an **Asynchronous command**.
- **Reset values (\*RST)**  
Default parameter values that are used directly after resetting the instrument (\*RST command) are indicated as **\*RST** values, if available.
- **Default unit**  
This is the unit used for numeric values if no other unit is provided with the parameter.
- **Manual operation**  
If the result of a remote command can also be achieved in manual operation, a link to the description is inserted.

### 7.2 Common Commands

Common commands are described in the IEEE 488.2 (IEC 625-2) standard. These commands have the same effect and are employed in the same way on different devi-

ces. The headers of these commands consist of "\*" followed by three letters. Many common commands are related to the Status Reporting System.

Available common commands:

*CLS.....	426
*ESE.....	426
*ESR?.....	426
*IDN?.....	427
*IST?.....	427
*OPC.....	427
*OPT?.....	427
*PRE.....	428
*PSC.....	428
*RCL.....	428
*RST.....	428
*SAV.....	429
*SRE.....	429
*STB?.....	429
*TRG.....	429
*TST?.....	429
*WAI.....	430

---

### \*CLS

Clear status

Sets the status byte (STB), the standard event register (ESR) and the `EVENT` part of the `QUESTIONABLE` and the `OPERATION` registers to zero. The command does not alter the mask and transition parts of the registers. It clears the output buffer.

**Usage:**                    Setting only

---

### \*ESE <Value>

Event status enable

Sets the event status enable register to the specified value. The query returns the contents of the event status enable register in decimal form.

**Parameters:**

<Value>                    Range:     0 to 255

---

### \*ESR?

Event status read

Returns the contents of the event status register in decimal form and subsequently sets the register to zero.

**Return values:**

<Contents>                Range:     0 to 255

**Usage:** Query only

### \*IDN?

Identification

Returns the instrument identification.

**Return values:**

<ID> "Rohde&Schwarz,<device type>,<serial number>,<firmware version>"

**Example:**

Rohde&Schwarz,AMU,  
1407.6004k02/000000,3.1.17.1-03.01.158

**Usage:** Query only

**Manual operation:** See "[Hardware Options / Software Options](#)" on page 144

### \*IST?

Individual status query

Returns the contents of the IST flag in decimal form. The IST flag is the status bit which is sent during a parallel poll.

**Return values:**

<ISTflag> 0 | 1

**Usage:** Query only

### \*OPC

Operation complete

Sets bit 0 in the event status register when all preceding commands have been executed. This bit can be used to initiate a service request. The query form writes a "1" into the output buffer as soon as all preceding commands have been executed. This is used for command synchronization.

### \*OPT?

Option identification query

Queries the options included in the instrument. For a list of all available options and their description refer to the data sheet.

**Return values:**

<Options> The query returns a list of options. The options are returned at fixed positions in a comma-separated string. A zero is returned for options that are not installed.

**Usage:** Query only

**Manual operation:** See "[Hardware Options / Software Options](#)" on page 144

---

**\*PRE** <Value>

Parallel poll register enable

Sets parallel poll enable register to the indicated value. The query returns the contents of the parallel poll enable register in decimal form.

**Parameters:**

<Value>                      Range:      0 to 255

---

**\*PSC** <Action>

Power on status clear

Determines whether the contents of the `ENABLE` registers are preserved or reset when the instrument is switched on. Thus a service request can be triggered when the instrument is switched on, if the status registers ESE and SRE are suitably configured. The query reads out the contents of the "power-on-status-clear" flag.

**Parameters:**

<Action>                      0 | 1

**0**

The contents of the status registers are preserved.

**1**

Resets the status registers.

---

**\*RCL** <Number>

Recall

Loads the instrument settings from an intermediate memory identified by the specified number. The instrument settings can be stored to this memory using the command `*SAV` with the associated number.

It also activates the instrument settings which are stored in a file and loaded using the `MMEMory:LOAD <number>, <file_name.extension>` command.

**Manual operation:** See "[Recall](#)" on page 171

---

**\*RST**

Reset

Sets the instrument to a defined default status. The default settings are indicated in the description of commands.

The command is equivalent to `SYSTem:PRESet`.

**Usage:**                      Setting only

**Manual operation:** See "[Preset](#)" on page 136

---

**\*SAV** <Number>

Save

Stores the current instrument settings under the specified number in an intermediate memory. The settings can be recalled using the command **\*RCL** with the associated number.

To transfer the stored instrument settings in a file, use the command **:MMEMory:STORe:STATe**.

**Manual operation:** See "Save" on page 169

---

**\*SRE** <Contents>

Service request enable

Sets the service request enable register to the indicated value. This command determines under which conditions a service request is triggered.

**Parameters:**

<Contents>                      Contents of the service request enable register in decimal form.  
   Bit 6 (MSS mask bit) is always 0.  
   Range:        0 to 255

---

**\*STB?**

Status byte query

Reads the contents of the status byte in decimal form.

**Usage:**                      Query only

---

**\*TRG**

Trigger

Triggers all actions waiting for a trigger event. In particular, **\*TRG** generates a manual trigger signal. This common command complements the commands of the **TRIGger** subsystem.

**Usage:**                      Event

---

**\*TST?**

Self-test query

Initiates self-tests of the instrument and returns an error code

---

**Return values:**

<ErrorCode>            **integer > 0 (in decimal format)**  
 An error occurred.  
 (For details see the Service Manual supplied with the instrument).

**0**  
 No errors occurred.

**Usage:**                Query only

**\*WAI**

Wait to continue

Prevents servicing of the subsequent commands until all preceding commands have been executed and all signals have settled (see also command synchronization and [\\*OPC](#)).

**Usage:**                Event

## 7.3 Preset Commands

The preset commands are not bundled in one subsystem. Therefore, they are listed separately in this section. In addition, a specific preset command is provided for each digital standard and for the fader. These specific commands are described in the associated subsystems.

Four presetting actions are available:

- Activating the default state of all internal instrument functions ([\\*RST](#) on page 428). Functions that concern the integration of the instrument into a measurement setup are not changed, e.g. GPIB address or reference oscillator source settings.
- Activating the preset state of the parameters related to the selected signal path ([:SOURCE<hw>:PRESet](#) on page 431)
- Activating the preset state of all parameters that are not related to the signal path ([:DEVICE:PRESet](#) on page 430)
- Activating the original state of delivery (factory reset, [:SYSTEM:FPRreset](#) on page 431). Only functions that are protected by a password remain unchanged as well as the passwords themselves.

**:DEVICE:PRESet**

Presets all parameters which are not related to the signal path, including the LF generator.

It also includes presetting the bit/block error measurement.

**Example:**                presets all instruments settings that are not related to the signal path

**Usage:**                Event

---

**:SOURce<hw>:PRESet**

The command presets all parameters which are related to the selected signal path.

This includes option 'Baseband In'.

Fading (if available) and transient recorder are only preset by command \*RST.

**Example:**                 SOUR:PRES  
                              presets all settings that are related to signal path

**Usage:**                    Event

---

**:SYSTem:PRESet**

Triggers an instrument reset. It has the same effect as:

- the PRESET key on the front panel
- the \*RST command

For an overview of the settings affected by the preset function, see [Chapter 5.2.2, "Default Instrument Settings - Preset Key"](#), on page 136.

**Example:**                 SYST:PRES  
                              All instrument settings (also those that are not currently active)  
                              are reset to their default values.

**Usage:**                    Setting only

---

**:SYSTem:FPReset**

Triggers an instrument reset to the original state of delivery.

**Note:** Since Factory Preset resets the Remote Channel and network settings to the default values, executing Factory Preset via remote control terminates the connection to the instrument, if these settings had been configured to values different to the default ones!

The factory preset function resets nearly all instrument settings. In addition to the regular preset by means of the PRESET key, a "Factory Preset" resets also the following values:

- Reference frequency settings ("Ref Oscillator" menu)
- Power on settings ("Level/EMF" menu)
- Network settings including hostname ("Setup" menu)
- Remote Channel settings including GPIB address ("Setup" menu)
- Start/Stop Display Update ("Setup" menu)
- Display and keyboard settings ("Setup" menu).

To maintain security, password settings and all settings protected by these passwords like disabled USB and LAN connections are not changed.

Not affected by the "Factory Preset" are also user data, lists or instrument settings files, created for example by means of the Save/Recall function.

<b>Example:</b>	<code>SYST:FPR</code> all instrument settings (also those that are not currently active) are reset to the factory values.
<b>Usage:</b>	Event
<b>Manual operation:</b>	See "Factory Preset" on page 161

## 7.4 Waveform and List Format

The R&S AMU uses a tag-oriented format for externally or internally generated waveforms as well as for data and control lists. The data can be transmitted via the GPIB interface from an external computer to the instrument and vice versa.

For these purposes the file is transmitted as a binary data block, using SCPI command `[ :SOURCE<hw> ] :BB:ARbitrary:WAVEform:DATA`.



A waveform version number is not necessary due to the flexible, tag-based form.

Tags are self-contained information units. Their general format is `{Name: Data}` or `{Name-Length: Data}`. The colon separates the name part and the data part. The colon can be followed by a space for the sake of legibility.

The **Name** identifies the tag. It is always expressed in capital letters.

The **Data** is tag-specific, and in most cases it is in ASCII plain text.

The **Length** specifies the number of bytes in a `WAVEFORM` tag, a `DATA LIST` tag or a `EMPTYTAG` (from `:to` }, ASCII integer).

Each waveform file must begin with the `TYPE` tag. The sequence of the remaining tags is arbitrary. For each tag an indication shows whether it must be included in the file concerned (mandatory) or may be included (optional).

Unknown tags are not analyzed by the R&S AMU. On the other hand they are left unchanged, are saved without an error message and can be read back again.

R&S AMIQ waveforms can also be loaded on the instrument, where they are converted internally into an R&S AMU waveform.

### 7.4.1 Tag Description

This section first describe the mandatory `TYPE` tag which identifies the file and is always located at the start of the file. The rest of the tags used in the R&S AMU are then described in alphabetical order. Most tags are valid for all three file types. If a tag is valid only for a single file type, e.g. only for a waveform, this fact is indicated in the description.



{TYPE: magic, xxxxxxxx}.....	433
{CLOCK: frequency}.....	434
{COMMENT: string} .....	434
{COPYRIGHT: string}.....	435
{DATA BITLENGTH: BitLength}.....	435
{DATA LIST-Length: #d0d1...dx...dN-1...}.....	435
{DATE: yyyy-mm-dd;hh:mm:ss}.....	436
{EMPTYTAG-Length: #EmptySequence}.....	436
{CONTROL LENGTH: ControlLength}.....	437
{LEVEL OFFS: RMSOffset_dB,PeakOffset_dB}.....	438
{SAMPLES: Samples}.....	439
{[TRACE] LIST [#]: Pos0:State0; Pos1:State1; ...PosN-1:StateN-1}.....	439
{WAVEFORM-Length: #I0Q0I1Q1...IxQx...IN-1QN-1...}.....	440
{MWV_SEGMENT_COUNT: NumOfSeg}.....	441
{MWV_SEGMENT_LENGTH: SamplesSeg0, SamplesSeg1, ..., SamplesSegN-1}.....	442
{MWV_SEGMENT_START: SampleStartOffsetSeg0, SampleStartOffsetSeg1, ..., SampleStartOffsetSegN-1}.....	442
{MWV_SEGMENT_CLOCK_MODE: Mode}.....	442
{MWV_SEGMENT_CLOCK: ClockSeg0, ClockSeg1, ..., ClockSegN-1}.....	443
{MWV_SEGMENT_LEVEL_OFFS: RMSOffs_dBSg0,PeakOffs_dBSg0, ..., RMSOffs_dBSgN-1, PeakOffs_dBSgN-1}.....	444
{MWV_SEGMENT_FILES: "FileNameSeg0.wv", "FileNameSeg1.wv", ..., "FileNameSegN-1.wv"}.....	444
{MWV_SEGMENTx_COMMENT: text}.....	444
{CONTROL LIST WIDTH4-Length: #m0m1...mx...mM-1}.....	444

---

### **{TYPE: magic, xxxxxxxx}**

#### **(mandatory, must be the first tag in the file)**

Identifies the file as a valid R&S AMU file. It must be present and must be the first in the waveform. If a file of the same name exists on the target medium, it is overwritten.

#### **Setting parameters:**

magic                      Designates the file type and has the following values:

##### **SMU-WV**

A valid R&S AMU waveform.

##### **SMU-MWV**

A valid R&S AMU multi-segment waveform.

##### **SMU-DL**

A valid R&S AMU data list.

##### **SMU-CL**

A valid R&S AMU control list.

xxxxxxx

Is an ASCII-coded checksum of the data part of the `WAVEFORM` tag in the file. This value is always 0 for data lists and control lists.

The checksum for waveforms is used for detecting transmission errors. If the `TYPE` tag contains 0 or a non-numeric value for the checksum, it is ignored.

It is calculated in accordance with the algorithm given below, where 'start' is a pointer to the first byte after the '#' character in the `WAVEFORM` tag and 'length' is the number of bytes between 'start' and the closing curly bracket (excluding the latter; 'length' must be divisible by 4 without a remainder):

```
UINT32 checksum(void *start, UINT32 length)
{
    UINT32 i, result = 0xA50F74FF;
    for(i=0; i < length/4; i++)
        result = result ^ ((UINT32 *)start)[i];
    return(result);
}
```

**Example:**

```
{TYPE: SMU-WV,106656}
BB:ARB:WAV:TAG? 'TYPE'
Queries the content of the TYPE tag.
Response: 'SMU-WV,106656'
This is a valid waveform.
```

**{CLOCK: frequency}****(mandatory for waveforms)**

The tag specifies the clock frequency at which the waveform has to be output, in Hz (on multi-segment waveforms this tag contains the maximal clock of all segments).

A query of `ARB:CLOCK?` after loading the waveform returns the value set using the `CLOCK` tag. This value can later be altered with the command `ARB:CLOCK?`.

**Example:**

```
{CLOCK: 54000000}
BB:ARB:WAV:TAG? 'CLOCK'
Queries the content of the CLOCK tag.
Response: 54000000
The clock frequency is set to 54 MHz.
```

**Usage:**

Setting only

**{COMMENT: string}**

The tag contains a plain text ASCII string of arbitrary length. The string is not analyzed in the R&S AMU. It is used to describe the file. The string is allowed to contain all printable ASCII characters except the closing curly bracket.

**Example:**           {COMMENT: File with data for 3GPP enhanced channels}  
 BB:ARB:WAV:TAG? 'COMMENT'  
 queries the content of the COMMENT tag of the selected waveform file.  
 Response: 'File with data for 3GPP enhanced channels'  
 the comment on the waveform reads "File with data for 3GPP enhanced channels".

**Usage:**           Setting only

### {COPYRIGHT: string}

The tag contains an ASCII string of arbitrary length. The string is not analyzed in the R&S AMU. It is used to store copyright information about the file content.

**Example:**           {COPYRIGHT: Rohde&Schwarz}  
 BB:ARB:WAV:TAG? 'COPYRIGHT'  
 queries the content of the COPYRIGHT tag of the selected waveform file.  
 Response: 'Rohde&Schwarz'  
 copyright resides with Rohde&Schwarz.

**Usage:**           Setting only

### {DATA BITLENGTH: BitLength}

(mandatory for data lists)

The tag contains the length of the data held in the DATA LIST tag in bits in ASCII format.

**Example:**           {DATA BITLENGTH: 444}  
 BB:DM:DLIS:TAG? 'DATA BITLENGTH'  
 queries the content of the DATA BITLENGTH tag of the selected data list file.  
 Response: '444'  
 the data list is 444 bits long.

**Usage:**           Setting only

### {DATA LIST-Length: #d0d1...dx...dN-1...}

(mandatory for data lists)

The tag contains the actual bit sequence of the data list in binary format.

#### Setting parameters:

Length	Defines the number of bytes in the DATA LIST tag in ASCII Format (for format see WAVEFORM length).
dx	Data bits in binary format (8-bit unsigned characters, MSB first).

**Example:** DATA LIST-17: #d0d1...dx...d127}  
16 bytes containing 128 data bits, first bit is the MS bit of the first byte.

**Usage:** Setting only

**{DATE: yyyy-mm-dd;hh:mm:ss}**

(optional)

The tag contains the date and time at which the file was created. The year must be expressed as four digits. The instrument does not analyze this tag.

**Example:** {DATE: 2009-04-02;14:32:12}  
BB:ARB:WAV:TAG? 'DATE'  
queries the content of the DATE tag of the selected waveform file.

Response: '2009-04-02;14:32:12'  
the waveform was created on April 2, 2009 at 14 hrs 32 min

**Usage:** Setting only

**{EMPTYTAG-Length: #EmptySequence}**

(mandatory in automatically generated one and multi-segment waveforms)

This tag is empty, i.e. contains no data, and is used as placeholder.

**Setting parameters:**

**Length** An ASCII integer value that specifies the number of bytes in the EMPTYTAG, i.e. defines the number of bytes from the colon : to the end brace }  
**Note:** If you change the content of a waveform file, change also the {EMPTYTAG-Length} value. For example, if you add a tag or add bytes to a tag, reduce the length by the number of newly introduced bytes.

**EmptySequence** An empty sequence containing blanks only. The number of used blanks is calculated as the difference between the hex addresses of the {WAVEFORM} tag and the hash sign # in the {EMPTYTAG}.  
The {WAVEFORM} tag always starts at hex address #4000.

**Example:**

```
{TYPE:SMU-WV, 837236424}
{COPYRIGHT:2003 Rohde&Schwarz SMU}
{DATE:2012-07-11;14:38:01}
{SAMPLES:80000}
{CLOCK:86666666.666666666}
{VECTOR MAX:1.000000038569158}
{LEVEL OFFS:3.333553817875577e-07,0}
{MARKER LIST 1:0:1;1:0;1249:0}
{MARKER LIST 2:0:1;1:0;1249:0}
{MARKER LIST 3:0:1;1:0;1249:0}
{MARKER LIST 4:0:1;1:0;1249:0}
{EMPTYTAG-15947:# ...}
{WAVEFORM-320017:#IQIQIQ...}
```

The example waveform file contains 436 (0x1b4) bytes before the # sign in the EMPTYTAG; the hex address of the # sign is 0x1b5. The {WAVEFORM} starts at 0x4000. The EMPTYTAG contains 15946 blanks and has a length of (15946+1) bytes.

**Usage:** Setting only

### {CONTROL LENGTH: ControlLength}

(optional / recommended for marker and control lists)

The tag specifies the length of *all* control or marker list in ASCII format.

The control length influences the way the marker and control lists are processed, in particular the way traces are repeated; see [Figure 7-1](#).

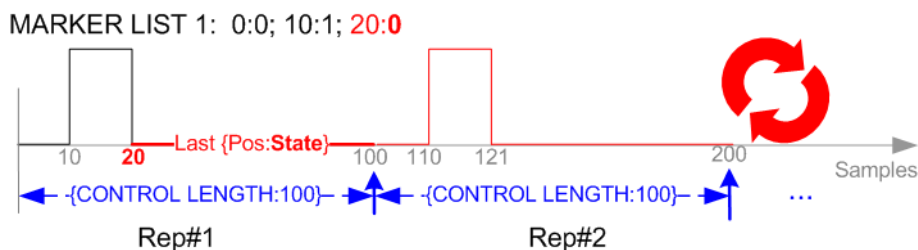

**Figure 7-1: Example: Processing of MARKER TRACE if CONTROL LENGHT is specified**

If the CONTROL LENGTH tag is not used, the marker and control list length are determined by the last position, that is the last {Pos:State} couple, defined in the particular [TRACE] LIST tag; see [Figure 7-2](#).

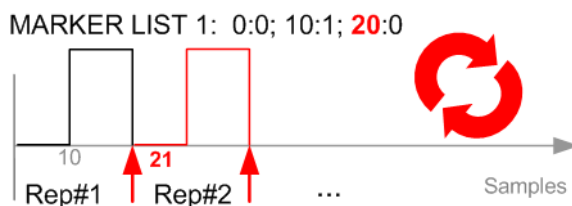

**Figure 7-2: Example: Processing of MARKER TRACE if CONTROL LENGHT is not used**

To maintain marker signals and waveform data synchronized, set the `CONTROL LENGTH` to be equal to the number of samples specified with the tag `SAMPLES`.

See also [Chapter 7.4.2, "How to Define Periodically Repeating Traces"](#), on page 445.

**Example:**

```
{CONTROL LENGTH: 500}
SOURCE:BB:ARBitary:CLISt:TAG? 'CONTROL LENGTH'
Queries the length of the control list.
Response: 500
```

---

### **{LEVEL OFFS: RMSOffset\_dB,PeakOffset\_dB}**

#### **(recommended for waveforms)**

The tag determines the level of the ARB signal in the waveform file. The offset levels define the offset of RMS and peak value relative to the 16-bit full scale modulation (-32767 to + 32767) = 0 dB.

#### **Setting parameters:**

**RMSOffset\_dB** Defines the RMS level offset of the signal relative to full scale ARB signal in the `WAVEFORM` tag. The offset is defined in ASCII float format. The value is always positive.  
A 3 dB value indicates that the RMS level of the signal is 3 dBs below the full scale.  
full scale = max. amplitude of vector of I/Q samples =  $|S_{IQ}|_{max} = \sqrt{I^2+Q^2}_{max} = 0$  dB

**PeakOffset\_dB** Defines the peak level offset of the signal relative to full scale for the ARB signal in the `WAVEFORM` tag. The offset is defined in ASCII float format.  
The value usually equals 0 dB as usually the I/Q samples (signed 16-bit integer values) are modulated to full scale: Full scale = 0 dB = max. amplitude of vector of I/Q samples =  $|S_{IQ}|_{max} = \sqrt{I^2+Q^2}_{max} = (2^{15})-1 = 32767$ .  
A positive `PeakOffset_dB` value indicates that a headroom to full scale is provided when generating the waveform. A negative `PeakOffset_dB` value indicates that overrange is likely for some samples, i.e. clipping might occur.  
The crest factor can be calculated from the two values as follows:  
Crest Factor =  $|PeakOffset\_dB - RMSOffset\_dB|$

**Example:**

```
{LEVEL OFFS: 3.45,2}
BB:ARB:WAV:TAG? 'LEVEL OFFS'
Queries the content of the LEVEL OFFS tag of the selected waveform file.
Response: 3.45,2
The level of the waveform is below full scale, clipping does not occur.
```

**Usage:** Setting only

**{SAMPLES: Samples}****(recommended for waveforms)**

The tag contains the number of I/Q samples in the waveform in ASCII format.

On multi-segment waveforms, this tag contains the total I/Q samples of all segments.

**Example:**                   {SAMPLES: 1000}  
                                   BB:ARB:WAV:TAG? 'SAMPLES'  
 Queries the content of the SAMPLES tag of the selected waveform file.  
 Response: 1000  
 The waveform contains 1000 I/Q samples.

**Usage:**                    Setting only

See also [Chapter 7.4.2, "How to Define Periodically Repeating Traces"](#), on page 445.

**{[TRACE] LIST [#]: Pos0:State0; Pos1:State1; ...PosN-1:StateN-1}****(mandatory for control lists / optional for waveforms)**

The tag contains the data for the marker and control signals in the control list or the marker signals of ARB waveforms.

Traces are processed different, depending on the selected [CONTROL LENGTH](#).

See also [Chapter 7.4.2, "How to Define Periodically Repeating Traces"](#), on page 445.

**Setting parameters:**

[TRACE]	MARKER   BURST   LEVATT   CW MODE   HOP   MAP Name of the marker or control signal. For ARB waveforms, it is only meaningful to define marker signals; in the ARB multi-segment waveforms these tags are ignored!
[#]	1 .. 4 Sets the marker or control trace number; supported is only LEVATT LIST 1.
Pos	Specifies in ASCII format the position (i.e. sample number or data value), with effect from which the binary State of the marker or of the control signal changes.
State	0   1 Specifies the binary state of the marker or of the control signal from Pos <sub>x</sub> to Pos <sub>x+1</sub> exclusive in ASCII format.

**Example:** `{MARKER LIST 1: 0:0;10:1;20:0;30:1}`  
`BB:DM:CLIS:TAG? 'MARKER LIST 1'`  
 Queries the content of the `MARKER LIST 1` tag of the selected control list file.

Response: `'0:0;10:1;20:0;30:1'`

The marker setting for samples 0 to 9 = 0 (low), for 10 to 19 = 1 (high) and for 20 to 29 = 0. From sample 30 onward the marker setting = 1.

**Example:** `{LEVATT LIST 1: 0:0;10:1;20:0;30:1}`  
`BB:DM:CLIS:TAG? 'LEVATT LIST 1'`  
 Queries the content of the `LEVATT LIST 1` tag of the selected control list file.

Response: `'0:0;10:1;20:0;30:1'`

Level attenuation applies to data values 10 to 19 (high) and from data value 30 onward.

**Usage:** Setting only

---

**{WAVEFORM-Length: #I0Q0I1Q1...IxQx...IN-1QN-1...}**

**(mandatory for waveforms)**

The tag contains the actual waveform data or multi-segment waveform data (I/Q stream).

Use the `TYPE` tag to define whether the waveform file contains a normal waveform or a multi-segment waveform.

The following figure shows the principle of multi-segment work mode.

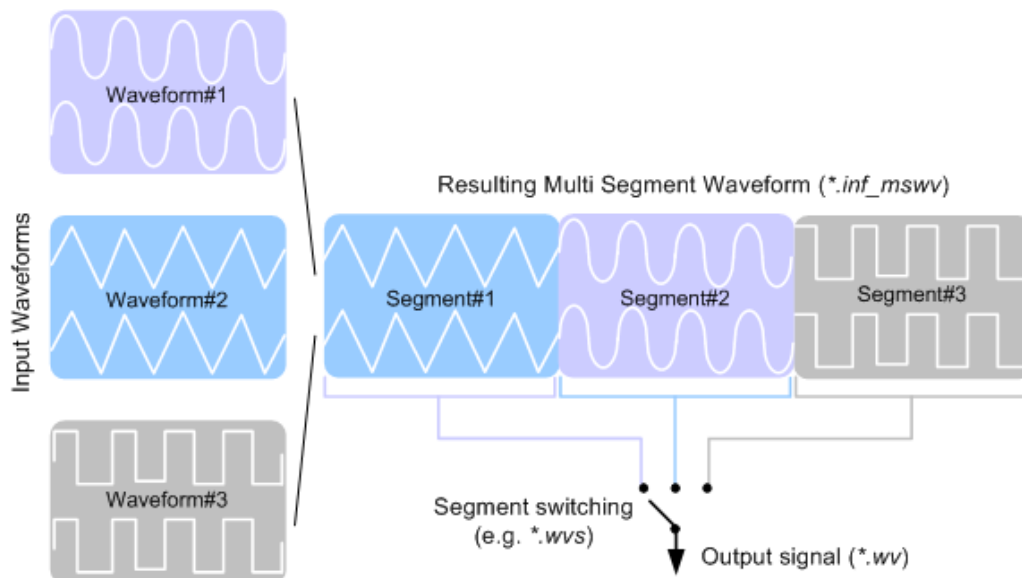



**Setting parameters:**

<b>Length</b>	Specifies the number of bytes in a <code>WAVEFORM</code> tag and is calculated as follows: $\text{Length} = \text{Number of I/Q pairs} * 4 \text{ (2 bytes per I and 2 bytes per Q value)} + 1 \text{ byte (the length of the \#)}$
<b>IxQx</b>	<code>IxQx...</code> represents binary data (16-bit signed integer in 2's complement notation) containing the I and Q component alternately and starting with the I component. Each component consists of 2 bytes in Little endian format representation, i.e least significant byte (LSB) first. The values of the 2 bytes in an I component and a Q component are in the range 0x0 to 0xFFFF (-32767 to +32767). This value is transferred to the D/A converter. This tag is also used to store multi-segment waveforms. The I/Q streams of the individual waveforms are directly concatenated to one collectively waveform I/Q stream. The number of segments and the start offset and length of the individual segments inside the total waveform I/Q stream is determined by the additional tags <code>MWV_SEGMENT_COUNT</code> , <code>MWV_SEGMENT_START</code> , and <code>MWV_SEGMENT_LENGTH</code> . Further <code>MWV_SEGMENT_...</code> tags are also available, for example for level and clock information.

**Example:****One segment waveform**

```
{WAVEFORM-401:#I0,Q0,I1,Q1,I2,Q2,...I99,Q99}
```

100 I/Q pairs with 4 bytes each are transmitted - none multi-segment

**Example:****Multi-segment waveform**

```
{WAVEFORM-1201:
```

```
#I0,Seg0,Q0,Seg0,I1,Seg0,Q1,Seg0,...I99,Seg0,Q99,Seg0,I0,Seg1,Q0,Seg1,I1,Seg1,  
Q1,Seg1,... I199,Seg1,Q199,Seg1}
```

2 segments: segment 0 with 100 I/Q pairs; segment 1 with 200 I/Q pairs. Each I/Q pair consists of 2\*16 bit = 4 bytes

**Usage:**

Setting only

**{MWV\_SEGMENT\_COUNT: NumOfSeg}****(mandatory for multi-segment waveforms)**

The tag contains the number of segments in the multi-segment waveform in ASCII integer format.

**Example:**

```
{MWV_SEGMENT_COUNT: 2}
```

Multi-segment waveform with 2 segments

**Usage:**

Setting only

---

**{MWV\_SEGMENT\_LENGTH: SamplesSeg0, SamplesSeg1, ..., SamplesSegN-1}**

**(mandatory for multi-segment waveforms)**

The tag contains a list of I/Q sample lengths for every segment in the multi-segment waveform in ASCII integer format.

**Example:**                    {MWV\_SEGMENT\_LENGTH: 100,200}  
2 segments: 100 samples in segment 0 and 200 samples in segment 1.

**Usage:**                     Setting only

---

**{MWV\_SEGMENT\_START:**

**SampleStartOffsetSeg0, SampleStartOffsetSeg1, ..., SampleStartOffsetSegN-1}**

**(mandatory for multi-segment waveforms)**

The tag contains a list of I/Q sample start offsets for every segment in the multi-segment waveform in ASCII integer format.

**Example:**                    {MWV\_SEGMENT\_START: 0,100}  
2 segments with 100 samples in segment 0 and 200 samples in segment 1.  
The start offset of first segment is 0 samples, start offset of next segment 1 is the sample length of segment 0 = 100 samples.

**Usage:**                     Setting only

---

**{MWV\_SEGMENT\_CLOCK\_MODE: Mode}**

**(mandatory for multi segment waveforms)**

The tag contains a string in ASCII format which supplies the clock rate mode, that was used for calculation of the multi segment output waveform.

The tag `CLOCK` contains always the highest clock rate of all segments.

The tag `MWV_SEGMENT_CLOCK` contains the clock rates of the individual segments.

**Setting parameters:**

Mode

**UNCHANGED**

The segments may have different clock rates.

During the multi segment calculation, the clock rates of all individual original waveforms were taken over unchanged in the segments of the multi segment output waveform (no software resampling is done).

If the segments have different clock rates, there are some restrictions on signal output, i.e. switching per external trigger and seamless switching between segments is not possible.

If all segments have already an identical clock rate, this mode is usually set to `HIGHEST`.

**HIGHEST**

All segments have an identical clock rate, which is the highest clock rate of all original waveforms.

If an individual original waveform has a lower clock rate, an upsampling to the highest clock rate will be performed on calculation of the multi segment output waveform.

**USER**

All segments have an identical clock rate, which is given by the user.

Note: Only upsampling is allowed, no downsampling!

If an individual original waveform has a lower clock rate, an upsampling to the user clock rate will be performed on calculation of the multi segment output waveform.

**Example:**

```
{MWV_SEGMENT_CLOCK_MODE: UNCHANGED}
{MWV_SEGMENT_CLOCK_MODE: HIGHEST}
{MWV_SEGMENT_CLOCK_MODE: USER}
```

**Usage:**

Setting only

**{MWV\_SEGMENT\_CLOCK: ClockSeg0, ClockSeg1, ..., ClockSegN-1}****(mandatory for multi segment waveforms)**

The tag contains a list of clock frequencies for every segment in the multi segment waveform in ASCII floating point format.

**Example:**

```
{MWV_SEGMENT_CLOCK: 100e6,80e6}
```

2 segments: clock of segment 0 is 100 MHz, clock of segment 1 is 80 MHz.

Note: If the segments have different clock frequencies, there are some restrictions on signal output, i.e. seamless switching between segments is only possible, if all segments have the same clock frequency. Software resampling (upsampling) can be used to bring all segments to the same clock.

**Usage:**

Setting only

---

**{MWV\_SEGMENT\_LEVEL\_OFFS:**  
**RMSOffs\_dBSg0,PeakOffs\_dBSg0, ..., RMSOffs\_dBSgN-1, PeakOffs\_dBSgN-1}**

**(mandatory for multi segment waveforms)**

The tag contains a list of level pairs in ASCII floating point format, one pair for every segment in the multi segment waveform. The first value of a level pair defines the rms offset and the second value the peak offset relative to the 16-bit full scale modulation (-32767; + 32767) = 0 dB. The meaning of one level value pair is the same as in the **LEVEL OFFS** tag for normal waveforms.

**Example:**                    {MWV\_SEGMENT\_LEVEL\_OFFS: 3.0,0.0,6.0,0.0}  
 2 segments: RMS level of segment 0 is 3dB below full scale;  
 RMS level of segment 1 is 6dB below full scale. Peak level of  
 both segments is 0 dB full scale.

**Usage:**                    Setting only

---

**{MWV\_SEGMENT\_FILES:**  
**"FileNameSeg0.wv", "FileNameSeg1.wv", ..., "FileNameSegN-1.wv"}**

**(optional for multi segment waveforms)**

The tag contains a list of file names for every segment in the multi segment waveform in ASCII format.

**Example:**                    {MWV\_SEGMENT\_FILES: "D:\user\sine.wv", "D:  
 \user\rect.wv"}

**Usage:**                    Setting only

---

**{MWV\_SEGMENTx\_COMMENT: text}**

**(optional for multi segment waveforms)**

The tag contains a user comment for a specific segment  $x = [0 \dots \text{NumOfSeg}-1]$  in the multi segment waveform in ASCII format.

**Example:**                    {MWV\_SEGMENT1\_FILES: segment 1 contains a QPSK  
 signal.}

**Usage:**                    Setting only

---

**{CONTROL LIST WIDTH4–Length: #m0m1...mx...mM-1}**

**(optional for waveforms and multi segment waveforms)**

The tag contains a binary marker element stream, which will be given out synchronously to the I/Q sample sequence. One marker element  $m_x$  consists of 4 bit, which are assigned to the 4 possible marker lines of the instrument (one bit per marker line). One 4 bit marker elements is needed for every I/Q sample in the **WAVEFORM** tag - so the number of marker elements  $M$  should be equal to the number of I/Q samples. The **CONTROL LENGTH** tag has to contain the number of all marker elements  $M$ .

MSB 7	Byte						LSB 1
Marker element $m_x$ (synchronous to I/Q Sample $x$ )				Marker element $m_{x+1}$ (synchronous to I/Q Sample $x+1$ )			
Marker 4	Marker 3	Marker 2	Marker 1	Marker 4	Marker 3	Marker 2	Marker 1

Figure 7-3: Marker element in 4-bit binary format bit order

For standard waveforms the `MARKER LIST x` tags are a more compact way to define markers, but in principle this `CONTROL LIST WIDTH4` format can also be used instead of the `MARKER LIST x` tags.

For multi segment waveforms this `CONTROL LIST WIDTH4` format is required for marker definition. The binary marker streams of the individual segments are directly concatenated (without any gap) to one collectively marker stream.

#### Setting parameters:

**Length** Defines the number of bytes in the `CONTROL LIST WIDTH4` tag in ASCII Format and is calculated as follow:  

$$\text{Length} = \text{Size of "\#"} (1 \text{ byte}) + \text{Number of marker elements } m_x * (4 \text{ bit}) / (8 \text{ bits/byte})$$
 The value is rounded up for byte alignment.

**$m_x$**  Marker element in 4-bit binary format.

**Example:** `{CONTROL LIST WIDTH4-51: # $m_0m_1\dots m_x\dots m_{99}$ }`  
 100 marker elements, each marker element with 4 bits

**Usage:** Setting only

## 7.4.2 How to Define Periodically Repeating Traces

If a marker trace is required that marks for example each frame start, it is sufficient to define the trace ones and repeat it over the length of a waveform. This is useful if you describe a long waveform and a periodical marker is required.

The following examples use marker traces; control lists are processed in the same way.

#### To define periodical marker trace

The waveform in the example on [Figure 7-4](#) consists of 3 frames, each frame is 100-samples long. The waveform is processed continuously ("Trigger Mode > Auto").

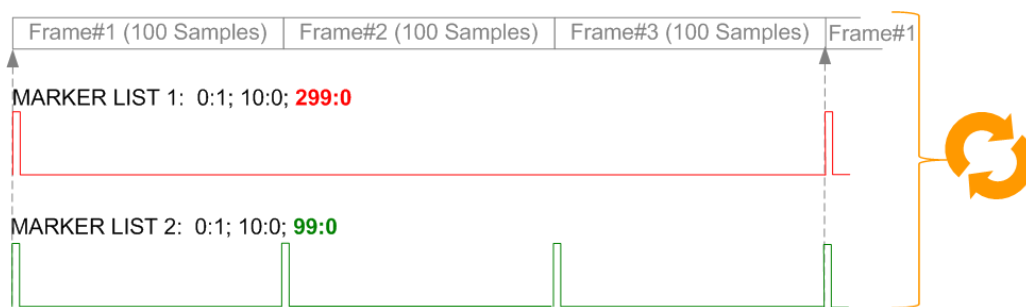

Figure 7-4: Example: Defining marker traces (*CONTROL LENGTH* tag is not used)

To define a restart marker and a frame start marker, use the following tags:

1. The waveform is 300 samples long, i.e. set `{SAMPLES: 300}`.
2. Set two `[TRACE] LIST` tags:
  - For Marker 1 that acts as a restart marker:  
`{MARKER LIST 1: 0:1; 10:0; 299:0}`
  - For Marker 2 that marks each frame start:  
`{MARKER LIST 2: 0:1; 10:0; 99:0}`
3. Do not use the `CONTROL LENGTH` tag.

The length of the repeated patterns is determined by the last sample number in the `[TRACE] LIST`, that is the last `{Pos:State}`.

#### Example: How the `CONTROL LENGTH` tag influences the processing of the traces

For the example on Figure 7-4, use the same marker traces and set the `CONTROL LENGTH` tag, e.g. `{CONTROL LENGTH: 150}`.

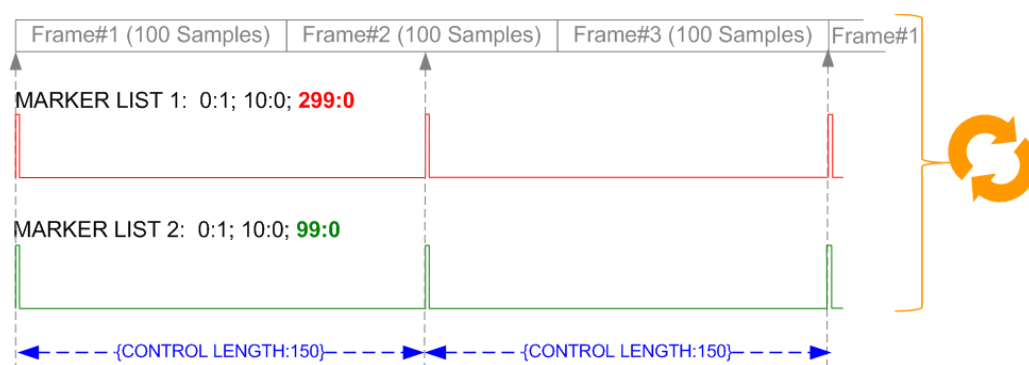

Figure 7-5: Example: Processing of control signals if the `CONTROL LENGTH` tag is used

The length of **all** control signals is determined by the `CONTROL LENGTH`. Observe how the marker traces are processed. In this example, both marker traces are repeated each 150 samples.

### 7.4.3 How to Manually Create a Waveform Using Tag File Format

The provided example uses a sine function in the I channel and a cosine function in the Q channel, each with 20 points. The example uses a short program written in the programming language C to calculate the sine and cosine values (see [Example "C-program for creating a waveform file"](#) on page 450). They are stored in the file `SICO.txt`. The decimal values in `SICO.txt` are normalized such that they are between  $-1.0$  and  $+1.0$ . The data is converted into binary format. The appropriate mandatory tags are added and the data is packed into the `WAVEFORM` tag. As result, the waveform file `SICO.wv` is generated.

This example follows the general principle of creating of a waveform manually, using the tag file format. The [Figure 7-6](#) illustrates this general workflow.

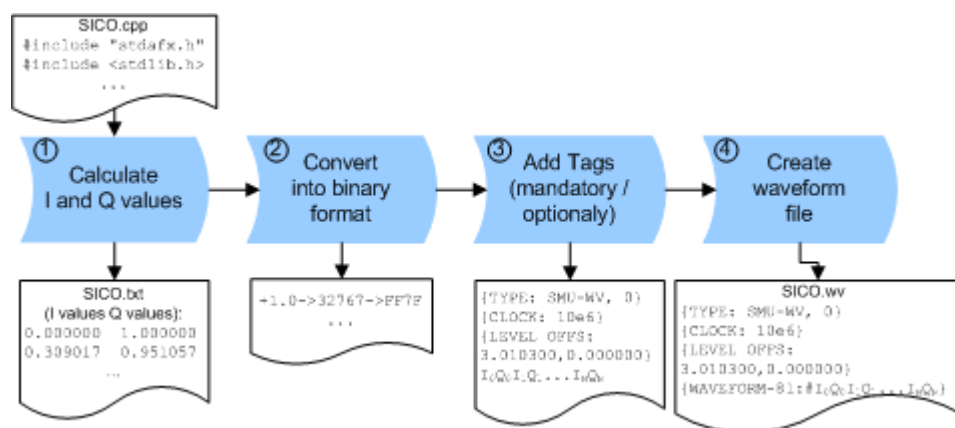

**Figure 7-6: Principle of creating a waveform manually**

The following steps outline how to create the waveform file `SICO.wv`:

1. Calculate the sine and cosine values, e.g. use the `SICO.cpp` program.  
The result is stored in the file `SICO.txt`.

```

0.000000  1.000000
0.309017  0.951057
0.587785  0.809017
0.809017  0.587785
0.951057  0.309017
1.000000  -0.000000
0.951057  -0.309017
0.809017  -0.587785
0.587785  -0.809017
0.309017  -0.951057
-0.000000 -1.000000
-0.309017 -0.951056
-0.587785 -0.809017
-0.809017 -0.587785
-0.951056 -0.309017
-1.000000  0.000000
-0.951056  0.309017
-0.809017  0.587785
-0.587785  0.809017
-0.309017  0.951057

```

*Figure 7-7: Contents of SICO.txt: first column Sine (I), second column Cosine (Q)*

- Convert the values from the file `SICO.txt` into binary format consisting of 16-bit signed integer numbers. The numeric range between  $-1.0$  and  $+1.0$  corresponds to the modulation range of the waveform 16-bit D/A converter of  $-32767$  to  $+32767$ .

```

+1.0 -> 32767 -> = 0x7FFF
0.0 -> 0 -> = 0x0000
-1.0 -> -32767 -> = 0x8001

```

The [Figure 7-8](#) shows the calculation and conversion steps. The highlighted columns contain the resulting I and Q values represented in Little endian format.



Sample n	deg = 360°/20 * n	I = sin(deg)	I <sub>quant,dec</sub> = I * FS = I * (2 <sup>15</sup> -1)	I <sub>quant,hex</sub>	I <sub>quant,hex</sub> (Little endian waveform file representation)	Q = cos(deg)	Q <sub>quant,dec</sub> = I * FS = I * (2 <sup>15</sup> -1)	Q <sub>quant,hex</sub>	Q <sub>quant,hex</sub> (Little endian waveform file representation)
0	0	0.000000	0	0000	0000 I <sub>0</sub>	1.000000	32767	7FFF	FF7F Q <sub>0</sub>
1	18	0.309017	10126	278E	8E27	0.951057	31163	79BB	BB79
2	36	0.587785	19260	4B3C	3C4B	0.809017	26509	678D	8D67
3	54	0.809017	26509	678D	8D67	0.587785	19260	4B3C	3C4B
4	72	0.951057	31163	79BB	BB79	0.309017	10126	278E	8E27
5	90	1.000000	32767	7FFF	FF7F	0.000000	0	0000	0000
6	108	0.951057	31163	79BB	BB79	-0.309017	-10126	D872	72D8
7	126	0.809017	26509	678D	8D67	-0.587785	-19260	B4C4	C4B4
8	144	0.587785	19260	4B3C	3C4B	-0.809017	-26509	9873	7398
9	162	0.309017	10126	278E	8E27	-0.951057	-31163	8645	4586
10	180	0.000000	0	0000	0000	-1.000000	-32767	8001	0180
11	198	-0.309017	-10126	D872	72D8	-0.951057	-31163	8645	4586
12	216	-0.587785	-19260	B4C4	C4B4	-0.809017	-26509	9873	7398
13	234	-0.809017	-26509	9873	7398	-0.587785	-19260	B4C4	C4B4
14	252	-0.951057	-31163	8645	4586	-0.309017	-10126	D872	72D8
15	270	-1.000000	-32767	8001	0180	0.000000	0	0000	0000
16	288	-0.951057	-31163	8645	4586	0.309017	10126	278E	8E27
17	306	-0.809017	-26509	9873	7398	0.587785	19260	4B3C	3C4B
18	324	-0.587785	-19260	B4C4	C4B4	0.809017	26509	678D	8D67
19	342	-0.309017	-10126	D872	72D8	0.951057	31163	79BB	BB79

Figure 7-8: I and Q values calculation and conversion

- Use an ASCII editor which is able to handle binary data. Create and add the following mandatory tags before this binary data set can be further processed:
  - TYPE
  - CLOCK
  - LEVEL OFFS

An example of the SICO.wv file contents could be:

```
{TYPE: SMU-WV, 0}{CLOCK: 10e6}{LEVEL OFFS: 3.010300,0.000000}
0000FF7F8E27BB79 ... 72D8BB79
```

To simplify the example, the checksum is set to 0, i.e. the instrument does not evaluate a checksum.

**Tip:** The tags TYPE, CLOCK, LEVEL OFFS and WAVEFORM are mandatory for each waveform. All other tags are optional and can be inserted after the TYPE tag in arbitrary order.

- Pack the binary data into a WAVEFORM tag with the described structure.

```
{WAVEFORM-Length: #I0Q0I1Q1I2Q2 ... InQn}
```

- Calculate the Length  
Length = Number of I/Q pairs \* 4 + 1 = 20\*4 + 1 = 81 bytes
- Place the string {WAVEFORM-81: # at the beginning of the data set
- Place the symbol } at the end of the data set

The contents of the waveform file SICO.wv for 20 I/Q pairs is now ready for operation and reads:

```
{TYPE: SMU-WV, 0}
{CLOCK: 10e6}
{LEVEL OFFS: 3.010300,0.000000}
{WAVEFORM-81: #I0Q0I1Q1...InQn}
```

**Note:** There is no readable representation for binary values in this document. This is why we use the sequence I0Q0I1Q1...InQn to characterize the binary code in the present example.

The following figure shows this waveform in a data editor.

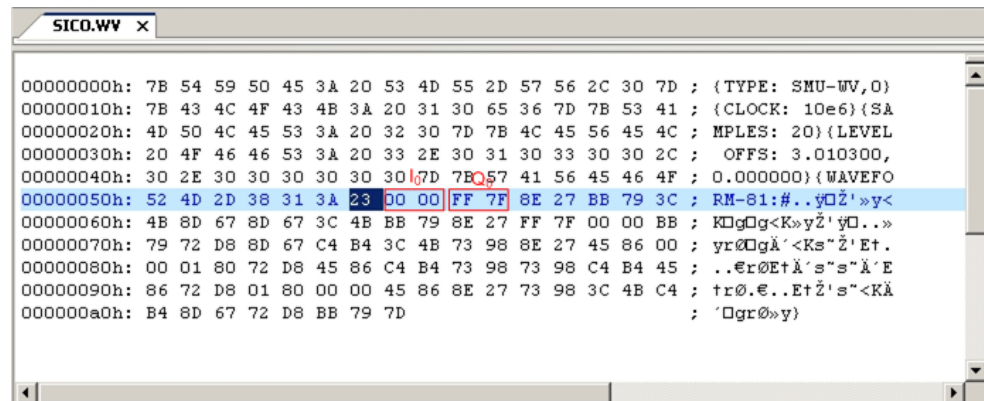

### Example: C-program for creating a waveform file

C-program SICO.cpp for creating the file SICO.txt containing 20 sine and cosine pairs, converting them into binary data and creating the waveform file SICO.wv.

```
// SICO.cpp
// Defines the entry point for the console application

#include "stdafx.h"
#include <stdlib.h>
#include <stdio.h>
#include <math.h>

int _tmain(int argc, _TCHAR* argv[])
{
    const unsigned int samples = 20;
    const float pi = 3.141592654f;
    int i;

    // SICO.txt
    // Creating the file SICO.txt containing 20 sine and cosine pairs
    float grad, rad;
    FILE *fp;
    fp = fopen("SICO.txt", "w");
    if (fp == 0)
        return;
    for (i=0; i<samples; i++)
    {
        grad = (360.0f / (float)samples) * (float)i;
        rad = grad * (pi / 180.0f);
        fprintf(fp, "%f %f\n", sin(rad), cos(rad));
    }
    fclose(fp);
}
```

```

// SICO.wv
// Generating a binary data set from the I/Q pairs in the file SICO.txt
// and storing the result to file SICO.wv
FILE *fp_sour, *fp_dest;
float i_float, q_float;
unsigned short i_usint, q_usint;
fp_sour = fopen("SICO.TXT", "rt");
if (fp_sour == 0)
    return -1;
fp_dest = fopen("SICO.WV", "wb");
if (fp_dest == 0)
{
    fclose(fp_sour);
    return -1;
}
// Write required tags to waveform file
fprintf(fp_dest, "{TYPE: SMU-WV,0}");
fprintf(fp_dest, "{CLOCK: 10e6}");
fprintf(fp_dest, "{SAMPLES: %d}", samples);
// RMS, Peak
fprintf(fp_dest, "{LEVEL OFFS: %f,%f}", -1.0f * 20.0f * log10(1.0f/sqrt(2.0f)), 0.0f);
fprintf(fp_dest, "{WAVEFORM-%d:#", (samples * 4) + 1);
for (i=0; i<samples; i++)
{
    // Read I/Q pair from ASCII file
    if (fscanf(fp_sour, "%f %f", &i_float, &q_float) == EOF)
        break;
    // Convert I/Q pair to unsigned short
    i_usint = (unsigned short)floor((i_float * 32767.0) + 0.5);
    q_usint = (unsigned short)floor((q_float * 32767.0) + 0.5);
    // Write converted I/Q pair to waveform file
    fwrite(&i_usint, 2, 1, fp_dest);
    fwrite(&q_usint, 2, 1, fp_dest);
}
fprintf(fp_dest, "});");
fclose(fp_dest);
fclose(fp_sour);
return 0;
}

```

#### 7.4.4 Creating an ASCII C-List Manually

When you create the C-list in the editor, as shown in the figure, you get an ASCII file with the extension \*.dm\_iqc (see the example [C-List ASCII File](#)).

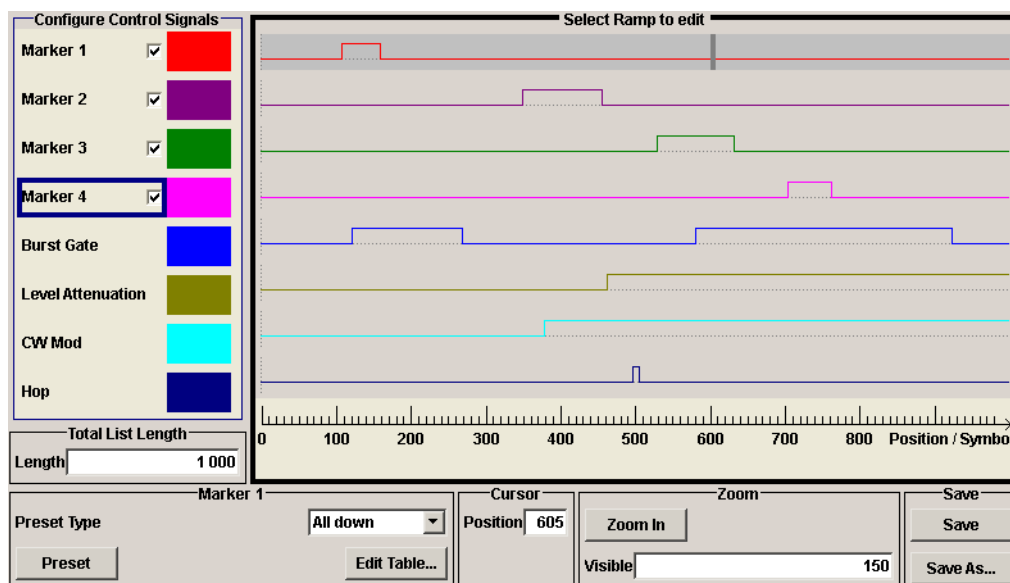

Figure 7-9: Representation in the C-List Editor

### Example: C-List ASCII File

C-List in ASCII format, corresponding to C-List editor [Figure 7-9](#):

```
{TYPE:SMU-CL}{COPYRIGHT:2003 Rohde&Schwarz SMU}{DATE:2011-07-19;14:58:44}
{HOP LIST:0:0;498:1;506:0}{CW MODE LIST:0:0;380:1}{LEVATT LIST 1:0:0;464:1}
{BURST LIST:0:0;122:1;270:0;582:1;924:0}
{MARKER LIST 4:0:0;706:1;764:0}{MARKER LIST 3:0:0;530:1;633:0}
{MARKER LIST 2:0:0;350:1;457:0}{MARKER LIST 1:0:0;108:1;160:0}
{CONTROL LENGTH:1000}
```

The tags to the traces in the C-List editor are:

- HOP LIST
- CW MODE LIST
- LEVATT LIST 1
- BURST LIST
- MARKER LIST 4
- MARKER LIST 3
- MARKER LIST 2
- MARKER LIST 1
- CONTROL LENGTH

CONTROL LENGTH defines the periodicity of the total C-List. The remaining tags define the individual markers or control traces in a combined state/starting time way within the C-List period.

If you want to write an ASCII C-List directly without using the C-List editor, a special syntax has to be taken into account:

- The tag and the following [state: start time]-pairs are separated by a colon ":".

- The [state: start time] pairs in turn are separated by semicolons ";".
- The list state can be either 0 or 1.
- The time unit is the simple period.

**Example:**

"CW MODE LIST 0:0;380:1" for a CW trace:

The list status starts at time 0 with 0, and at time point 380 symbol periods after start, it changes to 1.



With the commands `BB:DM:CLIST:...` you can also generate control lists in binary format, if required. See "DM Lists" on page 582.

### 7.4.5 Editing Waveform Files, Data and Control Lists

You can edit the internally and externally created waveform files, data and control lists. The waveform, data and control lists files contain binary and ASCII data.

Consider the following rules while editing files with binary data.

#### Rules for editing binary data (waveforms, data and control lists)

- **Use hex data editor**  
Always use a hex data editor to edit files containing binary data. Editing of binary data file with a text editor, even if you only change the ASCII part of the file, corrupts the file.
- **Adapt the length information in the {EMPTYTAG}**  
If you change the content of a waveform file, change also the {EMPTYTAG-Length} value.  
For example, if you add a tag or add bytes to an existing tag, reduce the length information by the number of newly introduced bytes.

## 7.5 BERT and BLER Subsystems

These subsystems contain the commands for the bit and block error rate measurement. Since the commands for these two subsystems are essentially identical, they are summarized in the following section.

:BLER:RESult?	454
:BERT:RESult?	454
:BLER:SEQuence	456
:BERT:SEQuence	456
:BLER:SETup:CLOCK[:POLarity]	456
:BERT:SETup:CLOCK[:POLarity]	456
:BLER:SETup:CORDer	457
:BLER:SETup:DATA[:POLarity]	457
:BERT:SETup:DATA[:POLarity]	457

:BLER:SETup:DEnable.....	457
:BERT:SETup:DEnable.....	457
:BERT:SETup:IGNore.....	458
:BLER:SETup:MCOunt.....	459
:BERT:SETup:MCOunt.....	459
:BLER:SETup:MERRor.....	459
:BERT:SETup:MERRor.....	459
:BERT:SETup:REStart[:STATe].....	459
:BERT:SETup:TYPE.....	460
:BLER:SETup:TYPE.....	460
:BLER:SETup:TIMeout.....	460
:BERT:SETup:TIMeout.....	460
:BLER:STARt.....	460
:BERT:STARt.....	460
:BLER:STATe.....	461
:BERT:STATe.....	461
:BLER:STOP.....	461
:BERT:STOP.....	461
:BLER:UNIT.....	462
:BERT:UNIT.....	462
[:SOURce]:INPut:BERT:IMPedance.....	462
[:SOURce]:INPut:BERT:THReshold.....	462
:TRIGger:BLER[:IMMediate].....	463
:TRIGger:BERT[:IMMediate].....	463

**:BLER:RESult?****:BERT:RESult?**

Queries the result of the last BER measurement/BLER measurement. The response consists of seven results separated by commas. In the first measurement following the start, intermediate results for the number of data bits/data blocks, error bits/errors and error rate are also queried. In the following measurements (only for `BERT:SEQ AUTO/` for `BLER:SEQ AUTO`) only the final results of each single measurement are queried

**Note:** At the end of a measurement, the restart of a new one is delayed until the first measurement result has been queried with `BERT:RES`. The resulting brief measurement interruption is irrelevant because the subsequent measurement will be synchronized within 24 data bits.

**Return values:**

&lt;Result&gt;

string

**<data bits/data blocks>**

Number of checked data bits/data blocks

**<errors>**

Number of error bits/errors

**<error rate>**

If no termination criterion has been reached since the beginning of the measurement, the current quotient of "Number of error bits/errors" and "Number of data bits/data blocks" is entered. As soon as at least one final result has been reached in continuous measurement, the most recent final result is entered.

**<measurement status>**

Status of measurement.

1 = Measurement has been terminated, i.e. the number of data bits/data blocks or error bits/errors preset by the commands

BERT|BLER:SETup:MCOUNT and

BERT|BLER:SETup:MError has been reached, or the measurement has been stopped by the command

BERT|BLER:STOP.

0 = Measurement has not been terminated.

**<clock detected>**

Status of clock line

1 = Clock line active

0 = Clock line not active

**<data detected>**

Status of data line

1 = Data line active (only clocked data is detected; if the clock signal is missing, a data change is also not detected).

0 = Data line is not active.

**<synchronization status>**

1 = The measurement is synchronized, i.e. the clock and data lines are active and the "Number of error bits/errors" to "Number of data bits/data blocks" ratio is better than 0.1, so that the measurement ratio can be assumed to be realistic.

0 = The measurement is not synchronized.

**Example:**

BERT:RES

queries the results of the bit error rate measurement.

Response: "1000,5,5E-4,1,1,1,1"

The measurement has been terminated, and synchronization has been performed. Out of 1000 data bits, 5 error bits were measured, yielding an error rate of 0.005.

**Usage:**

Query only

**Manual operation:**

See "Data Bits" on page 195

---

**:BLER:SEquence** <Sequence>

**:BERT:SEquence** <Sequence>

Selects the type of measurement: single or continuous measurement.

These commands are automatically set to AUTO by `BERT:START` or `BLER:START`.

**Parameters:**

<Sequence> AUTO | SINGle

**AUTO**

Continuous measurement. If one or both termination criteria are met, the measurement in progress is terminated. At the end of a measurement, the restart of a new one is delayed until the first measurement result has been queried with `BERT:RES`. The resulting brief measurement interruption is irrelevant because the subsequent measurement will be synchronized within 24 data bits.

**SIINGle**

Single measurement. A single measurement must be started with `:TRIG:BERT`. A single measurement is terminated once the set number of data bits/blocks or number of errors is reached

\*RST: AUTO

**Example:**

`BERT:SEQ SING`  
selects single measurement.

**Example:**

`TRIG:BERT`  
starts the single measurement.

**Options:**

Dependencies: These commands are automatically set to AUTO by `BERT:START` or `BLER:START`

**Manual operation:** See "[Mode](#)" on page 198

---

**:BLER:SETup:CLOCK[:POLarity]** <Polarity>

**:BERT:SETup:CLOCK[:POLarity]** <Polarity>

Sets the polarity of the active slope of the feedback clock.

**Parameters:**

<Polarity> RISing | FALLing

**RISing**

The positive slope of the clock signal is active.

**FALLing**

The negative slope of the clock signal is active.

\*RST: RISing

**Example:**

`BERT:SET:CLOC FALL`  
selects the falling slope of the clock signal as the active slope.

**Manual operation:** See "[Clock Slope](#)" on page 199



---

**:BLER:SETup:CORDer** <COrder>

Sets the byte order of the checksum (CRC).

**Parameters:**

<COrder>                    LSB | MSB

**LSB**

The checksum starts with the least significant byte.

**MSB**

The checksum starts with the most significant byte.

\*RST:            LSB

**Example:**

BLER:SET:CORD MSB

the checksum starts with the most significant byte.

**Manual operation:**    See "[CRC Order](#)" on page 206

---

**:BLER:SETup:DATA[:POLarity]** <Polarity>

**:BERT:SETup:DATA[:POLarity]** <Polarity>

Sets the polarity of the feedback data bits.

**Parameters:**

<Polarity>                    NORMal | INVerted

**NORMal**

High level stands for a logic 1, low level for a logic 0.

**INVerted**

Low level stands for a logic 1, high level for a logic 0.

\*RST:            NORMal

**Example:**

BERT:SET:DATA INV

sets inversion of data signal.

**Manual operation:**    See "[Data Polarity](#)" on page 199

---

**:BLER:SETup:DENable** <DENable>

**:BERT:SETup:DENable** <DENable>

Activates/deactivates the use of the **Data Enable** signal and the polarity of the signal if it is used. The **Data Enable** signal marks the data that is actually to be evaluated for the BER measurement. Any data in addition to the PRBS sequence is masked and thus not evaluated (e.g. sync, preambles, other channels, etc that are present in the data bits supplied by the DUT).

**Parameters:**

&lt;DEnable&gt; OFF | LOW | HIGH

**OFF**

Any signal at the **Data Enable** input is ignored; all data at the BERT data input is used for the measurement.

**HIGH**

The **Data Enable** signal is used. The only data measured is the data at the BERT data input during a high level of the **Data Enable** signal. The measurement is interrupted during a low level of the **Data Enable** signal.

**LOW**

The **Data Enable** signal is used. The only data measured is the data at the BERT data input during a low level of the **Data Enable** signal. The measurement is interrupted during a high level of the **Data Enable** signal.

\*RST: OFF

**Example:**

BERT:SET:DEN HIGH

The measurement is interrupted during the low level of the **Data Enable** input.

**Manual operation:** See "[Data Enable](#)" on page 200

:BERT:SETup:IGNore &lt;Ignore&gt;

Activates/deactivates ignoring of pure "0" or "1" bit sequences at least 32 bits long. Activating excludes faulty frames from the measurement. In the case of some mobile radio standards, pure "0" or "1" bit sequences are generated when errors (e.g. an incorrect checksum) are detected within a frame. These sequences, instead of the frame data, are provided for the BER measurement and signal that the frame in question should not be used for the measurement.

**Parameters:**

&lt;Ignore&gt; OFF | ZERO | ONE

**OFF**

Pattern Ignore is not active.

**ONE**

Bit sequences consisting of 32 or more consecutive "1" data are not used (i.e. ignored) for the BER measurement.

**ZERO**

Bit sequence consisting of 32 or more consecutive "0" data are not used (i.e. ignored) for the BER measurement.

\*RST: OFF

**Example:**

BERT:SET:IGN ONE

specifies that bit sequences of "1" data at least 32 bits long are not used for the measurement.

**Manual operation:** See "[Pattern Ignore](#)" on page 201

---

**:BLER:SETup:MCOunt <MCount>**

**:BERT:SETup:MCOunt <MCount>**

Enters the number of transmitted data bits/data blocks to be checked before the measurement is terminated. With a BER measurement, data that was suppressed by `BERT:SETup:DEnable` is not counted. This termination criterion always terminates the measurement after the specified number of data bits/data blocks. Starting from this point, the fourth value is output with 1 (= terminate measurement) if the result is queried with `:BERT|BLER:RES`. If the continuous measurement mode (`BERT|BLER:SEQ AUTO`) has been selected, the measurement is restarted once the results have been queried.

**Parameters:**

<MCount>                    integer  
                                  Range:        0 to 4294967295  
                                  \*RST:        1E7

**Example:**                    `BERT:SET:MCO 1E6`  
                                  sets a measurement over 1000000 data bits.

**Example:**                    `BLER:SET:MCO 1E3`  
                                  sets a measurement over 1000 data blocks.

**Manual operation:**    See "[Max Data Bits](#)" on page 198

---

**:BLER:SETup:MERRor <MError>**

**:BERT:SETup:MERRor <Merror>**

Enters the number of errors to occur before the measurement is terminated. This termination criterion always terminates the measurement after the specified number of errors. Starting from this point, the fourth value is output with 1 (= terminate measurement) if the measurement result is queried with `:BERT|BLER:RES`.

**Parameters:**

<Merror>                    integer  
                                  Range:        0 to 4294967295  
                                  \*RST:        100

**Example:**                    `BERT:SET:MERR 1E4`  
                                  sets a measurement over 1000 errors.

**Manual operation:**    See "[Max Errors](#)" on page 198

---

**:BERT:SETup:REStart[:STATe] <State>**

Activates/deactivates an external restart of the BER measurement.

**Parameters:**

<State>                    INTernal | EXTernal  
                                  \*RST:        INTernal

**Example:**                    `BERT:SET:REST:STAT INTernal`  
                                  The external signal restarts the measurement.

**Manual operation:** See "External Restart" on page 200

---

**:BERT:SETup:TYPE** <Type>

Selects the PRBS sequence. The data generated by the PRBS generator is used as a reference for the measurement.

**Parameters:**

<Type> PRBS9 | PRBS11 | PRBS15 | PRBS16 | PRBS20 | PRBS21 | PRBS23

\*RST: PRBS9

**Example:**

BERT:SET:TYPE PN15

sets a pseudo random binary sequence consisting of 32767 bits.

**Manual operation:** See "PRBS" on page 199

---

**:BLER:SETup:TYPE** <Type>

Queries the CRC polynomial used. CCITT CRC 16 :  $G(x) = x^{16} + x^{12} + x^5 + x^1$  is the CRC polynomial supported.

**Parameters:**

<Type> CRC16

\*RST: CRC16

**Example:**

BLER:SET:TYPE

queries the type of measurement.

**Example:**

Response: CRC16

**Manual operation:** See "BLER Type" on page 206

---

**:BLER:SETup:TIMEout** <Timeout>

**:BERT:SETup:TIMEout** <Timeout>

Sets the time out.

**Parameters:**

<Timeout> float

Range: 0.1 to 1

Increment: 0.001

\*RST: 0.1

---

**:BLER:START**

**:BERT:START**

Starts a continuous measurement.

These commands automatically set BERT:SEquence or BLER:SEquence to AUTO and BERT:STATe or BLER:STATe to ON.

**Example:**            BERT:STAR  
                          starts a continuous measurement.

**Usage:**             Event

**Manual operation:** See "Mode" on page 198

**:BLER:STATe** <State>  
**:BERT:STATe** <State>

Switches the measurement on/off. Depending on the selected mode, either a continuous measurement (BERT|BLER:SEQ AUTO) or a single measurement (BERT|BLER:SEQ SING) is carried out. A single measurement must be triggered (:TRIG:BERT|BLER).

These commands are automatically set to ON by BERT:START or BLER:START and to OFF by BERT:STOP or BLER:STOP.

**Parameters:**

<State>                0 | 1 | OFF | ON  
\*RST:                 0

**Example:**            BERT:SEQ SING  
                          selects a single measurement.  
                          BERT:STAT ON  
                          switches the BER measurement on.

**Example:**            TRIG:BERT  
                          starts a single measurement.

**Manual operation:** See "State" on page 195

**:BLER:STOP**  
**:BERT:STOP**

Stops an ongoing measurement.

These commands automatically set BERT:STATe or BLER:STATe to OFF

.

**Example:**            BERT:STOP  
                          stops the measurement. To start a new measurement, the BER measurement must be switched on again by BERT:STATe ON.

**Usage:**             Event

**Manual operation:** See "Terminated By" on page 196

---

**:BLER:UNIT** <Unit>

**:BERT:UNIT** <Unit>

Sets the unit for the error rate display on the screen. **BERT** | **BLER:RES** always specifies the error rate as the quotient of "Number of errors" and "Number of data items", unaffected by this command.

**Parameters:**

<Unit>                    ENgineering | SCientific | PCT | PPM

**ENgineering**

The error rate is output in exponential notation with the exponent  $-3$  or  $-6$ .

**SCientific**

The error rate is output in scientific notation, i.e. standardized to one place to the left of the decimal.

**PCT**

The error rate is output in percent.

**PPM**

The error rate is output in parts per million.

\*RST:            ENgineering

**Example:**

BERT:UNIT PPM

selects the unit "ppm" for the display of the error rate.

**Manual operation:** See "[Bit Error Rate](#)" on page 195

---

**[:SOURce]:INPut:BERT:IMPedance** <Impedance>

Sets the impedance of the BERT inputs **CLOCK**, **DATA**, **DATA ENABLE** and **RESTART**.

**Parameters:**

<Impedance>            G1K | G50 | G10K

\*RST:            G1K

**Example:**

INP:BERT:IMP G50

The impedance of the BERT inputs is set to 50 ohm to ground.

**Manual operation:** See "[Impedance](#)" on page 199

---

**[:SOURce]:INPut:BERT:THReshold** <Threshold>

Sets the high/low threshold of the BERT inputs **Clock**, **Data**, **Data Enable** and **Restart**. In the case of positive polarity, this threshold determines the point as of which a signal is high (active) or low (inactive).

**Parameters:**

<Threshold> float  
 Range: 0.01 to 2  
 Increment: 0.01  
 \*RST: 1  
 Default unit: Volt

**Example:**

```
INP:BERT:THR 1 V
```

A high/low threshold of 1 volt is set at the BERT inputs. The signal is high (active) for a signal voltage of 1 volt and higher.

**Manual operation:** See ["Threshold"](#) on page 199

**:TRIGger:BLER[:IMMEDIATE]**

**:TRIGger:BERT[:IMMEDIATE]**

Triggers a single bit error rate or block error rate measurement if the single trigger mode (BERT|BLER:SEQ SING) is selected.

**Example:**

```
BERT:SEQ SING
```

selects the single trigger mode.

**Example:**

```
TRIG:BERT
```

starts a single bit error rate measurement.

**Usage:**

Event

## 7.6 CALibration Subsystem

The CALibration system contains the commands for adjustment. Adjustment is triggered by the query commands. The response "0" indicates error-free adjustment, and the response "1" means that an error occurred during adjustment.

<a href="#">:CALibration&lt;hw&gt;:ALL[:MEASure]?.....</a>	463
<a href="#">:CALibration&lt;hw&gt;:BBIN[:MEASure]?.....</a>	464
<a href="#">:CALibration&lt;hw&gt;:DAC[:MEASure]?.....</a>	464
<a href="#">:CALibration&lt;hw&gt;:ROSCillator[:DATA].....</a>	464

**:CALibration<hw>:ALL[:MEASure]? [<Force>]**

Starts all internal adjustments that do not require external measurement equipment.

With two-path instruments, adjustment is performed for both paths.

**Query parameters:**

<Force> string

**Return values:**

<Measure> select

**Example:** `CAL:ALL:MEAS?`  
starts the adjustment of all functions for the entire instrument.  
Response: "0"  
adjustment has been performed successfully.

**Usage:** Query only

**Manual operation:** See "[Adjust All](#)" on page 141

---

#### **:CALibration<hw>:BBIN[:MEASure]?**

Starts adjustment of the analog I/Q input. The I/Q input is adjusted with respect to DC offset and gain.

**Return values:**  
<Measure> 0 | 1 | OFF | ON  
\*RST: 0

**Example:** `CAL:BBIN:MEAS?`  
starts the adjustment of the analog I/Q input.  
Response: 0  
adjustment has been performed successfully.

**Usage:** Query only

**Manual operation:** See "[Adjust Baseband Input](#)" on page 142

---

#### **:CALibration<hw>:DAC[:MEASure]?**

Starts adjustment of the DAC board

**Return values:**  
<Measure> 0 | 1 | OFF | ON  
\*RST: 0

**Example:** `CAL:DAC:MEAS?`  
starts the adjustment of the DAC board of path A.  
Response: 0  
adjustment has been performed successfully.

**Usage:** Query only

**Manual operation:** See "[Adjust DAC Board](#)" on page 141

---

#### **:CALibration<hw>:ROSCillator[:DATA] <Data>**

Sets the calibration value for the custom defined external adjustment.

**Parameters:**  
<Data> integer  
Range: 0 to INT\_MAX  
\*RST: 0



## 7.7 CLOCK Subsystem

The CLOCK system contains the commands for configuration of the signals at the clock output and input connectors.

:CLOCK:INPut:FREQuency?	465
:CLOCK:INPut:SLOPe	465
:CLOCK:OUTPut:MODE	465
:CLOCK:OUTPut:SOURce	466

---

### :CLOCK:INPut:FREQuency?

Queries the measured frequency of the external clock signal. An external clock reference must be supplied at the CLOCK input.

#### Return values:

<Frequency>            float  
                               Range:     0 to max  
                               Increment: 0.001  
                               \*RST:     0

**Example:**            CLOC:INP:FREQ?  
                               queries the measured frequency of the external clock reference.

**Usage:**                Query only

**Manual operation:**   See "[Measured External Clock](#)" on page 296

---

### :CLOCK:INPut:SLOPe <Slope>

Sets the active slope of an externally applied clock signal at the CLOCK connector.

#### Parameters:

<Slope>                NEGative | POSitive  
                               \*RST:     POSitive

**Example:**            CLOC:INP:SLOP NEG  
                               The active slope of the external clock signal is the falling slope.

**Manual operation:**   See "[Clock Input Slope](#)" on page 150

---

### :CLOCK:OUTPut:MODE <Mode>

Sets the output of bit or symbol clock pulses at the CLOCK OUT connector at the rear panel.

#### Parameters:

<Mode>                SYMBol | BIT  
                               \*RST:     SYMBol

**Example:**            CLOC:OUTP:MODE SYMB  
                               The internal symbol clock is output.

**Manual operation:** See "Clock Output Mode " on page 150

---

**:CLOCK:OUTPut:SOURce** <Source>

Queries the path for which the clock signal at the CLOCK OUT connector is to be output.

**Parameters:**

<Source>                   A  
 \*RST:                    A

**Example:**

CLOC:OUTP:SOUR  
 queries the path for which the clock signal at the CLOCK OUT connector is to be output.  
 Response: A  
 The clock signal of path is output at the CLOCK OUT connector.

**Options:**                   R&S AMU-B9/10/11 and B13

**Manual operation:** See "Clock Output Source" on page 150

## 7.8 DIAGnostic Subsystem

The DIAGnostic system contains the commands used for instrument diagnosis and servicing. SCPI does not define any DIAGnostic commands; the commands listed here are all Device-specific. All DIAGnostic commands are query commands which are not influenced by \*RST.

:DIAGnostic<hw>:BGInfo?	466
:DIAGnostic<hw>:BGInfo:CATalog?	467
:DIAGnostic:INFO:OTIMe?	467
:DIAGnostic:INFO:POCounT?	468

---

**:DIAGnostic<hw>:BGInfo?** [<Board>]

Checks the modules available in the instrument using the variant and revision state.

If the command is sent without parameters being specified, a complete list of all modules is returned (the various entries are separated by commas). The length of the list is variable and depends on the instrument equipment configuration.

If the command is sent with parameters, a list of the specified modules is returned (the various entries are separated by commas). A list of modules names can be called up using the command :DIAGnostic<hw>:BGInfo:CATalog? on page 467.

For two-path instruments, the path for which the query is performed is determined by the numerical suffix.

**Query parameters:**

<Board>                   string

**Return values:**

<BgInfo> < Module name> <Module stock number incl. variant> <Module revision> <Module serial number>

Each entry for one module consists of four parts which are separated by space characters.

**Example:**

DIAG:BGIN  
 Queries the instrument configuration.  
 Response: MBRD, SATT3C, BBINS, BBINR, BBOUT, . . . .  
 returns the data of all available modules.  
 DIAG:BGIN? 'MBRD'  
 Queries the configuration of the motherboard.  
 Response: MBRD 1141.3501.02 1.5.3 100023  
 Module motherboard with stock number 1141.3501.01 has revision 1.5.3 and serial number 100023.

**Usage:**

Query only

**Options:**

DIAGnostic2 only with second option R&S AMU-B13 or -B9/10/11

**Manual operation:** See "[Assembly](#)" on page 142

**:DIAGnostic<hw>:BGInfo:CATalog?**

Queries the names of the assemblies available in the instrument.

**Suffix:**

<hw> 1|2  
 Instrument path

**Return values:**

<Catalog> string

A complete list of all assemblies is returned (the various entries are separated by commas). The length of the list is variable and depends on the instrument equipment configuration.

**Example:**

DIAG:BGIN:CAT  
 queries the names of the assemblies.  
 Response: MBRD, SATT3C, BBINS, BBINR, BBOUT, . . . .

**Usage:**

Query only

**Options:**

DIAGnostic2 only with second option R&S AMU-B13 or -B9/10/11

**:DIAGnostic:INFO:OTIME?**

The command queries the number of operation hours.

**Return values:**

<OTIME> float

**Example:**           DIAG:INFO:OTIM  
 queries the operation hours.  
 Response: 100023  
 The instrument was operated for 100023 hours up to now.

**Usage:**            Query only

**Manual operation:** See "Operation Time / h" on page 142

#### **:DIAGnostic:INFO:POCount?**

The command queries the number of power-on events.

**Return values:**

<Pocount>           float

**Example:**           DIAG:INFO:POC  
 queries the number of power on events.  
 Response: 123  
 The instrument was switched on for 123 times up to now.

**Usage:**            Query only

**Manual operation:** See "Power On Count" on page 142

## 7.9 DISPlay Subsystem

The DISPlay subsystem contains the commands to set the power-save mode of the instrument.

:DISPlay:ANNotation:AMPLitude.....	468
:DISPlay:ANNotation:FREQuency.....	469
:DISPlay:ANNotation[:ALL].....	469
:DISPlay:DIALog:CLOSe.....	469
:DISPlay:DIALog:CLOSe:ALL.....	469
:DISPlay:DIALog:ID?.....	469
:DISPlay:DIALog:OPEN.....	470
:DISPlay:IQ:OUTPut:LEVel:TYPE?.....	470
:DISPlay:PSAVe:HOLDoff.....	470
:DISPlay:PSAVe[:STATe].....	471
:DISPlay:UPDate.....	471

#### **:DISPlay:ANNotation:AMPLitude <State>**

Indicates asterisks instead of the level values in the status bar.

**Parameters:**

<State>            0 | 1 | OFF | ON  
 \*RST:            1

**Example:**           DISP:ANN:AMPL ON  
 suppresses the level display.

**Manual operation:** See "Annotation Amplitude" on page 160

---

**:DISPlay:ANNotation:FREQuency <State>**

Indicates asterisks instead of the frequency values in the status bar.

**Parameters:**

<State>            0 | 1 | OFF | ON  
 \*RST:            1

**Example:**            DISP:ANN:FREQ ON  
 suppresses the frequency display.

**Manual operation:** See "Annotation Frequency" on page 160

---

**:DISPlay:ANNotation[:ALL] <State>**

Displays asterisks instead of the level and frequency values in the status bar of the instrument. This setting is particularly useful when you remotely control the instrument.

**Parameters:**

<State>            0 | 1 | OFF | ON  
 \*RST:            1

**Example:**            DISP:ANN:AMPL ON  
 shows asterisks instead of frequency and level values.

---

**:DISPlay:DIALog:CLOSe <DialogId>**

Closes the specified dialog. To determine the dialog identifier, use command : [DISPlay:DIALog:ID?](#).

**Setting parameters:**

<DialogId>            string

**Example:**            DISP:DIAL:CLOS "<dialog ID>"  
 closes the dialog, determined with the "<dialog ID>".

**Usage:**            Setting only

---

**:DISPlay:DIALog:CLOSe:ALL**

Closes all open dialogs.

**Example:**            DISP:DIAL:CLOS:ALL

**Usage:**            Event

---

**:DISPlay:DIALog:ID?**

Returns the dialog identifiers of the open dialogs in a string separated by blanks.

**Return values:**

<DialogIdList> string

**Example:**

DISP:DIAL:ID?

Response: "<dialog ID(1)> <dialog ID(2)> ...

<dialog ID(n)>"

returns the Ids of all opened dialogs.

**Usage:**

Query only

**:DISPlay:DIALog:OPEN <DialogId>**

Opens the specified dialog. To determine the dialog identifier, use command :

[DISPlay:DIALog:ID?](#).

**Setting parameters:**

<DialogId> string

**Example:**

DISP:DIAL:OPEN "<dialog ID>"

opens the dialog, determined with the "<dialog ID>".

**Usage:**

Setting only

**:DISPlay:IQ:OUTPut:LEVel:TYPE?**

Selects the power mode for level output.

**Return values:**

<Type> PLEVel | RPEak

\*RST: PLEVel

**Example:**

DISP:IQ:OUTP:LEV:TYPE PLEVEL

outputs the level.

**Usage:**

Query only

**:DISPlay:PSAVe:HOLDoff <HoldoffTimeMin>**

Sets the waiting time for the screen-save mode of the display.

**Parameters:**

<HoldoffTimeMin> integer

Range: 1 to 60

\*RST: 10

Default unit: minute

**Example:**

DISP:PSAV:HOLD 8

sets the timeout of the screen saver to 8 minutes.

**Manual operation:**

See "[Wait Time](#)" on page 151

**:DISPlay:PSAVe[:STATe] <State>**

Activates the screen-save mode of the display. If activated, the display including back-light is completely switched off after the elapse of the wait time, provided no entries via front panel, external mouse or external keyboard are made. To determine the wait time, use command `:DISPlay:PSAVe:HOLDoff`.

This mode is recommended for protecting the display, especially if you operate the instrument via remote control.

**Parameters:**

<State>            0 | 1 | OFF | ON  
\*RST:            0

**Example:**            `DISP:PSAV ON`  
                          activates screen saver mode.

**Manual operation:** See "[Screen Saver Active](#)" on page 151

**:DISPlay:UPDate <Update>**

Activates the refresh mode of the display.

**Parameters:**

<Update>            0 | 1 | OFF | ON  
\*RST:            1

**Example:**            `DISP:UPD ON`  
                          activates automatic update of the display at defined time intervals.

## 7.10 FORMat Subsystem

The FORMat subsystem contains the commands which determine the format of the data that the R&S AMU returns to the controller. This affects all query commands which return a list of numerical data or block data. Reference is made to this in the descriptions of the commands.

For two-path instruments, the data format is set simultaneously for both paths.

<a href="#">:FORMat:BORDER</a> .....	471
<a href="#">:FORMat[:DATA]</a> .....	472
<a href="#">:FORMat:SREGister</a> .....	472

**:FORMat:BORDER <Border>**

Determines the sequence of bytes within a binary block. This only affects blocks which use the IEEE754 format internally.

**Parameters:**

<Border>                    NORMal | SWAPped

**NORMal**

The instrument expects (with setting commands) and sends (with queries) the least significant byte of each IEEE754 floating-point number first and the most significant byte last.

**SWAPped**

The instrument expects (with setting commands) and sends (with queries) the most significant byte of each IEEE754 floating-point number first and the least significant byte last.

\*RST:            NORMal

**Example:**

FORM:BORD SWAP

the data is transferred with the most significant bit first.

**:FORMat[:DATA] <Data>**

Determines the data format which the R&S AMU uses to return data. When data is transferred from the control computer to the instrument, the instrument detects the data format automatically. In this case, the value set here is irrelevant.

**Parameters:**

<Data>                    ASCii | PACKed

**ASCii**

Numerical data is transferred as plain text separated by commas.

**PACKed**

Numerical data is transferred as binary block data. The format within the binary data depends on the command. The various binary data formats are explained in the description of the parameter types.

\*RST:            ASCii

**Example:**

FORM ASC

The data is transferred as ASCII data.

**:FORMat:SREGister <Format>**

Determines the numerical format which is returned when the status registers are queried.



**Parameters:**

&lt;Format&gt;

ASCIi | BINary | HEXadecimal | OCTal

**ASCIi**

The register content is returned as a decimal number.

**BINary**

The register content is returned as a binary number. #B is placed in front of the number.

**HEXadecimal**

The register content is returned as a hexadecimal number. #H is placed in front of the number.

**OCTal**

The register content is returned as an octal number. #Q is placed in front of the number.

\*RST:       ASCIi

**Example:**

FORM: SREG HEX

The register content is returned as a hexadecimal number.

## 7.11 HCOpy Subsystem

The HCOpy subsystem contains the commands to generate a hardcopy of the display.

:HCOpy:DATA?	474
:HCOpy:DEvice	474
:HCOpy:DEvice:LANGUage	474
:HCOpy[:EXECute]	474
:HCOpy:FILE[:NAME]	475
:HCOpy:FILE[:NAME]:AUTO?	475
:HCOpy:FILE[:NAME]:AUTO:DIRectory	475
:HCOpy:FILE[:NAME]:AUTO:DIRectory:CLEar	476
:HCOpy:FILE[:NAME]:AUTO:FILE?	476
:HCOpy:FILE[:NAME]:AUTO[:FILE]:DAY?	476
:HCOpy:FILE[:NAME]:AUTO[:FILE]:DAY:STATE	477
:HCOpy:FILE[:NAME]:AUTO[:FILE]:MONTH?	477
:HCOpy:FILE[:NAME]:AUTO[:FILE]:MONTH:STATE	477
:HCOpy:FILE[:NAME]:AUTO[:FILE]:NUMBer?	478
:HCOpy:FILE[:NAME]:AUTO[:FILE]:PREFix	478
:HCOpy:FILE[:NAME]:AUTO[:FILE]:PREFix:STATE	478
:HCOpy:FILE[:NAME]:AUTO[:FILE]:YEAR?	479
:HCOpy:FILE[:NAME]:AUTO[:FILE]:YEAR:STATE	479
:HCOpy:FILE[:NAME]:AUTO:STATE	479
:HCOpy:IMAGe:FORMat	479
:HCOpy:IMAGe:SIZE	480
:HCOpy:REGion	480
:HCOpy:PRINter:COLor[:STATE]	480
:HCOpy:PRINter:LIST?	480
:HCOpy:PRINter[:NAME]	481
:HCOpy:PRINter:PAGE:MARGins	481

:HCOPY:PRINter:PAGE:ORientation.....	481
:HCOPY:PRINter:PAGE:SIZE.....	482
:HCOPY:PRINter:PAGE:UNIT.....	482

---

### :HCOPY:DATA?

The command transfers the hardcopy data directly as a NByte stream to the remote client.

#### Return values:

<Data>                    block data

**Example:**                HCOP:DEV:LANG JPG  
                               HCOP:DATA?  
                               transfers the hardcopy to the remote client.

**Usage:**                    Query only

---

### :HCOPY:DEvice <Device>

#### Parameters:

<Device>                    FILE  
                               \*RST:            FILE

**Example:**                HCOP:DEV FILE  
                               the hardcopy will be stored in a file.

**Manual operation:**    See "[Destination](#)" on page 163

---

### :HCOPY:DEvice:LANGuage <Language>

Selects the bitmap graphic format for the screenshot. It is also possible to directly retrieve the data using command HCOP:DATA?. This command is an alias to command HCOPY:IMAGE:FORMat.

#### Parameters:

<Language>                BMP | JPG | XPM | PNG  
                               \*RST:            PNG

**Example:**                HCOP:DEV:LANG BMP  
                               selects bitmap as image format.  
                               HCOP:FILE 'E:\HCOPY'  
                               defines the directory, path and file name for storing the hard-  
                               copy.  
                               HCOP  
                               triggers the hardcopy generation.

**Manual operation:**    See "[File Options](#)" on page 164

---

### :HCOPY[:EXECute]

Triggers the generation of a hardcopy.

**Example:** HCOPI  
triggers the generation of a hardcopy of the current display.

**Usage:** Event

**Manual operation:** See "Save" on page 166

#### :HCOPY:FILE[:NAME] <Name>

Creates/selects a file into which the hardcopy will be stored. The path is specified together with the file name. Access to the file via remote control is possible using the commands of the MMEM-Subsystem. In contrast, command `HCOPY:DATA?` transfers the hardcopy contents directly to the remote client where they can be further processed.

If automatic file naming is activated, the hardcopy is stored into a file with an automatically generated name (commands `HCOPY:FILE[:NAME]:AUTO:...`).

**Parameters:**

<Name> string

**Example:** `HCOPY:FILE:NAME 'E:\HCOPY'`  
defines the hardcopy file name.

**Manual operation:** See "File Info" on page 164

#### :HCOPY:FILE[:NAME]:AUTO?

Queries the path including the file name of the file with automatically generated name.

**Return values:**

<Auto> string

**Example:** see `:HCOPY:FILE[:NAME]:AUTO:FILE?` on page 476

**Usage:** Query only

**Manual operation:** See "File Options" on page 164

#### :HCOPY:FILE[:NAME]:AUTO:DIRectory <Directory>

Sets the directory into which the hardcopy files will be stored if auto naming is activated (`HCOPY:FILE:AUTO:STAT ON`). The directory will be created if it does not exist yet.

**Parameters:**

<Directory> string  
\*RST: .\HCOPY

**Example:** `HCOPY:FILE:AUTO:DIR 'E:\'`  
defines the destination directory 'E:\'

**Manual operation:** See "File Options" on page 164

**:HCOPY:FILE[:NAME]:AUTO:DIRectory:CLEar**

Deletes all files with extensions "bmp", "img", "png" and "xpm" in the directory set for automatic naming.

**Example:** HCOP:FILE:AUTO:DIR:CLE  
deletes all image files with extensions "bmp", "img", "png" and "xpm".

**Usage:** Event

**Manual operation:** See "File Options" on page 164

**:HCOPY:FILE[:NAME]:AUTO:FILE?**

Queries the file name that what generated using the automatic naming settings. By default the automatically generated file name is composed of:

<Prefix><YYYY><MM><DD><Number>.<Format>.

Each component can be deactivated/activated separately to individually design the file name.

**Return values:**

<File> string

**Example:** HCOP:DEV:LANG BMP  
selects output format \*.bmp.  
HCOP:FILE:AUTO:DIR 'E:\'  
defines the destination directory 'E:\'  
HCOP:FILE:AUTO:PREFIX 'gen'  
the file name starts with the prefix 'gen'. The usage of automatic naming with prefix and date in the file name is preset (...:STAT ON).  
HCOP  
triggers the generation of a hardcopy of the current trace.  
HCOP:FILE:AUTO?  
queries the path including the file name  
Response:  
E:\gen101012008001.bmp'  
HCOP:FILE:AUTO:FILE?  
queries the file name  
Response: 'gen101012008001.bmp'

**Usage:** Query only

**Manual operation:** See "File Info" on page 164

**:HCOPY:FILE[:NAME]:AUTO[:FILE]:DAY?**

Queries the day of the current system date which will be used in the file name if automatic naming is activated.

**Return values:**

<Day> integer  
 Range: 1 to 31  
 \*RST: 1

**Example:**

HCOPY:FILE:AUTO:DAY?  
 returns the day in the date part of the automatic file name.

**Usage:** Query only

**:HCOPY:FILE[:NAME]:AUTO[:FILE]:DAY:STATe <State>**

Activates the usage of the day in the automatic file name.

**Parameters:**

<State> 0 | 1 | OFF | ON  
 \*RST: 1

**Example:**

HCOPY:FILE:AUTO:DAY:STAT OFF  
 deactivates the use of the day in the automatically generated file name.

**Manual operation:** See "[File Options](#)" on page 164

**:HCOPY:FILE[:NAME]:AUTO[:FILE]:MONTH?**

Queries the month in the date part in the automatic file name.

**Return values:**

<Month> integer  
 Range: 1 to 12  
 \*RST: 1

**Example:**

HCOPY:FILE:AUTO:MONT?  
 queries the month in the date part in the automatic file name.

**Usage:** Query only

**:HCOPY:FILE[:NAME]:AUTO[:FILE]:MONTH:STATe <State>**

Activates the usage of the month in the automatic file name.

**Parameters:**

<State> 0 | 1 | OFF | ON  
 \*RST: 1

**Example:**

HCOPY:FILE:AUTO:MONT:STAT OFF  
 deactivates the usage of the month in the automatic file name.

**Manual operation:** See "[File Options](#)" on page 164

**:HCOPY:FILE[:NAME]:AUTO[:FILE]:NUMBER?**

Queries the number in the automatic file name. The number is assigned in such a way that always the lowest possible value for a unique file name within the selected path is used.

On initially switching on the device the number will be reset to the lowest possible value. Starting with number 0 the output directory will be scanned for already existing files. As long as files with the same name are existing the number will be incremented by 1. The number will be automatically set to a number so that the resulting file name will be unique within the selected path. The current number will not be saved in the save recall file but will be temporarily stored within the database. On subsequent saves the number will be incremented.

**Return values:**

<Number>                    integer  
                                  Range:        0 to 999999  
                                  \*RST:        0

**Example:**                    HCOPY:FILE:AUTO:NUMB?  
                                  queries the number in the automatic file name.

**Usage:**                        Query only

**Manual operation:**    See "[File Options](#)" on page 164

**:HCOPY:FILE[:NAME]:AUTO[:FILE]:PREFIX <Prefix>**

Sets the prefix part in the automatic file name. The usage of the prefix is activated with command `HCOPY:FILE:AUTO:PREFIX:STAT ON`.

**Parameters:**

<Prefix>                        string  
                                  \*RST:        HCopy

**Example:**                    HCOPY:FILE:AUTO:PREFIX 'Snapshot'  
                                  appends "Snapshot" as prefix to the generated file name.

**Manual operation:**    See "[File Options](#)" on page 164

**:HCOPY:FILE[:NAME]:AUTO[:FILE]:PREFIX:STATE <State>**

Activates the usage of the prefix in the automatic file name. The prefix is entered with command `HCOPY:FILE:AUTO:PREFIX`.

**Parameters:**

<State>                        0 | 1 | OFF | ON  
                                  \*RST:        1

**Example:**                    HCOPY:FILE:AUTO:PREFIX:STAT OFF  
                                  deactivates the usage of the prefix in the automatic file name.

**Manual operation:**    See "[File Options](#)" on page 164

---

**:HCOPY:FILE[:NAME]:AUTO[:FILE]:YEAR?**

Queries the year in the date part in the automatic file name.

**Return values:**

<Year> integer  
Range: 1784 to 8000  
\*RST: 0

**Example:** HCOPY:FILE:AUTO:YEAR?  
queries the year in the date part in the automatic file name.

**Usage:** Query only

---

**:HCOPY:FILE[:NAME]:AUTO[:FILE]:YEAR:STATe <State>**

Activates the usage of the year in the automatic file name.

**Parameters:**

<State> 0 | 1 | OFF | ON  
\*RST: 1

**Example:** HCOPY:FILE:AUTO:YEAR:STAT OFF  
deactivates the usage of the year in the automatic file name.

**Manual operation:** See "[File Options](#)" on page 164

---

**:HCOPY:FILE[:NAME]:AUTO:STATe <State>**

Activates/deactivates automatic naming of the hardcopy files.

**Parameters:**

<State> 0 | 1 | OFF | ON  
\*RST: 1

**Example:** HCOPY:FILE:AUTO:STAT OFF  
deactivates automatic naming.

**Manual operation:** See "[Automatic Naming](#)" on page 163

---

**:HCOPY:IMAGe:FORMat <Format>**

This command selects the bitmap graphic format for the screenshot. It is also possible to directly retrieve the data using command `HCOPY:DATA?`.

This command is an alias to command `HCOPY:DEVIce:LANGUage`.

**Parameters:**

<Format> BMP | JPG | XPM | PNG  
\*RST: BMP

**Example:** HCOPY:IMAG:FORM XPM  
selects the image format XPM.

**Manual operation:** See ["File Options"](#) on page 164

---

#### **:HCOPY:IMAGe:SIZE <Size>**

The command selects the image size of the hardcopy. The first value of the size setting defines the width, the second value the height of the image.

**Parameters:**

<Size>                    string  
 \*RST:                    depends on device

**Example:**                    HCOPY:IMAG:SIZE 640,480  
 sets width and height of the image.

---

#### **:HCOPY:REGion <Region>**

Selects the area to be copied.

You can create a snapshot of the screen or an active dialog.

**Parameters:**

<Region>                    ALL | DIALog  
 \*RST:                    ALL

**Example:**                    HCOPY:REG DIAL

**Manual operation:** See ["File Options"](#) on page 164

---

#### **:HCOPY:PRINter:COLor[:STATe] <State>**

Defines whether the hardcopy is printed in color or grayscale.

**Parameters:**

<State>                    0 | 1 | OFF | ON  
**ON**  
 prints in color.  
**OFF**  
 prints in gray scale  
 \*RST:                    OFF

---

#### **:HCOPY:PRINter:LIST?**

The command queries the available printers. If the list is empty, no printer driver is installed.

**Return values:**

<List>                    string

**Example:**                    HCOPY:PRIN:LIST?  
 returns a list of the available printers.

**Usage:**                    Query only



---

**:HCOPY:PRINter[:NAME] <Name>**

The command selects the printer.

**Parameters:**

<Name> string

**Example:** HCOPY:PRIN:NAME "printer1"  
selects printer printer1.

---

**:HCOPY:PRINter:PAGE:MARGins <Top>, <Bottom>, <Left>, <Right>**

The command defines the margins of the paper for printing the hardcopy. The values are entered in the sequence <top,bottom,left,right>, the values are separated by commas. A dot is used as decimal separator. Depending on the set physical unit by the parameter Unit, width and height are expressed in cm or inches.

**Parameters:**

<Top>	float
	Range: 0 to 356
	Increment: 0.01
	*RST: 2.5,2.5,2.5,2.5
<Bottom>	float
	Range: 0 to 356
	Increment: 0.01
	*RST: 2.5
<Left>	float
	Range: 0 to 356
	Increment: 0.01
	*RST: 2.5
<Right>	float
	Range: 0 to 356
	Increment: 0.01
	*RST: 2.5

**Example:** HCOPY:PRIN:PAGE:UNIT IN  
sets the physical unit for the page layout values to inches.  
HCOPY:PRIN:PAGE:MARG 2.5,2.0,1.5,1.5  
sets the margin values of the page layout to top=2.5 inches, bot-  
tom=2.0 inches, left=1.5 inches and right=.1.5 inches.

---

**:HCOPY:PRINter:PAGE:ORientation <Orientation>**

The command defines the orientation of the printer page..

**Parameters:**

<Orientation> PORTRait | LANDscape  
\*RST: PORTRait

**Example:** `HCOP:PRIN:PAGE:ORI LAND`  
selects landscape orientation for the printer page.

---

**:HCOPy:PRINter:PAGE:SIZE <Size>**

The command selects the size of the printer paper.

**Parameters:**

<Size> LETTER | LEGal | EXECutive | A4 | A5

\*RST: LETTER

**Example:** `HCOP:PRIN:PAGE:SIZE LETT`  
sets the page size to letter format.  
`HCOP:PRIN:PAGE:SIZE?`  
returns the selected page size, e.g. LETT

---

**:HCOPy:PRINter:PAGE:UNIT <Unit>**

This command defines the physical unit used for defining the page size and margins.

**Parameters:**

<Unit> CM | IN

\*RST: CM

**Example:** `HCOP:PRIN:PAGE:UNIT IN`  
selects unit inch.

## 7.12 KBOard Subsystem

The KBOard system contains the commands to set the external keyboard.

[:KBOard:LANGuage](#)..... 482

[:KBOard:LAYout](#)..... 483

---

**:KBOard:LANGuage <Language>**

This command selects the keyboard language. The assignment of some keys depends on the selected language.

**Parameters:**

<Language> US | DE

\*RST: US

**Example:** `KBO:LANG US`  
selects keyboard language American English.

**Usage:** SCPI confirmed

**Manual operation:** See "[Layout \(Keyboard Settings\)](#)" on page 151

**:KBOard:LAYout** <Layout>

Selects the keyboard language. The assignment of some keys depends on the selected language.

**Parameters:**

<Layout> CHINese | DANish | DUTCh | DUTBe | ENGLish | ENGUK |  
FINNish | FRENch | FREBe | FRECa | GERMan | ITALian |  
JAPanese | KORean | NORWegian | PORTuguese | RUSSian |  
SPANish | SWEDish | ENGUS  
\*RST: ENGLish

**Example:**

KBO:LAY US  
activates American keyboard layout.

**Manual operation:** See "[Layout \(Keyboard Settings\)](#)" on page 151

## 7.13 MMEMory Subsystem

The MMEMory subsystem (**Mass Memory**) contains the commands for managing files and directories as well as for loading and storing complete instrument settings in files.

The various drives can be selected using the "mass storage unit specifier " <msus>. The internal hard disk is selected with **D**:\, and a memory stick which is inserted at the USB interface is selected with **E**:\. The resources of a network can also be selected with <msus> in the syntax of the respective network, for example using the UNC format (Universal Naming Convention): \\server\share.

The default drive is determined using the command **MMEMory:MSIS** <msus>.



The **C**: drive is a protected system drive. This drive should not be accessed. Reconstruction of the system partition will not be possible without loss of data.



Use the command **:SYSTEM:MMEMory:PATH:USER?** to query the path of the directory for user-defined data.

### 7.13.1 File Naming Conventions

To enable files in different file systems to be used, the following file naming conventions should be observed.

The file name can be of any length and no distinction is made between uppercase and lowercase letters.

The file and the optional file extension are separated by a dot. All letters and numbers are permitted (numbers are, however, not permitted at the beginning of the file name). If possible, special characters should not be used. The use of the slashes "\" and "/" should be avoided since they are used in file paths. A number of names are reserved

for the operating system, e.g. CLOCK\$, CON, AUX, COM1 . . . COM4, LPT1 . . . LPT3, NUL and PRN.

In the R&S AMU all files in which lists and settings are stored are given a characteristic extension. The extension is separated from the actual file name by a dot (see [Chapter 4.7.2.1, "Extensions for User Files"](#), on page 127 for an overview of the file types).

The two characters "\*" and "?" function as "wildcards", meaning they are used for selecting several files. The "?" character represents exactly one character, while the "\*" character represents all characters up to the end of the file name. "\*.\*" therefore stands for all files in a directory.

When used in conjunction with the commands, the parameter <file\_name> is specified as a string parameter with quotation marks. It can contain either the complete path including the drive, only the path and the file name, or only the file name. The file name must include the file extension. The same applies for the parameters <directory\_name> and <path>.

Depending on how much information is provided, either the values specified in the parameter or the values specified with the commands `MMEM:MSIS` (default drive) and `MMEM:CDIR` (default directory) are used for the path and the drive settings in the commands.

Before the instrument settings can be stored in a file, they have to be stored in an intermediate memory using common command `*SAV <number>`. The specified number is subsequently used in the `:MMEMory:STORe:STATe` on page 493 command. Also, subsequently to loading a file with instrument settings with command `:MMEMory:LOAD:STATe` on page 492, these settings have to be activated with the common command `*RCL <number>`.

## 7.13.2 Extensions for User Files

The following table lists all available file extensions for user files. The currently available files on the instrument depend on the installed options.

*Table 7-1: List of the automatically assigned file extensions in the instrument*

Function/Digital Standard	List type	Contents	File suffix
Instrument State	Settings	Instrument settings	*.savrcl
"Arbitrary Waveform Generator"	Waveform	ARB waveforms ARB multi segment waveforms	*.wv
	Waveform	ARB multi carrier settings	*.arb_multcarr
	Configuration data	Configuration file for creation of multisegment ARB waveforms	*.inf_mswv
	Play List	ARB Sequencing List	*.wvs
"DM"	Data List	Digital modulation data	*.dm_iqd *.tdm
	Control List	Data to control digital modulation	*.dm_iqc

Function/Digital Standard	List type	Contents	File suffix
	Settings	Digital modulation settings	*.dm
	User Standard	Digital modulation user standard	*.dm_stu
	User Mapping	Digital modulation user mapping	*.vam
	User Filter	Digital modulation user filter	*.vaf
EX-IQ-BOX	User Settings	EX-IQ-BOX User Defined Settings	*.iqbox
"Fading"	Fading	Fading data	*.fad
"GSM/EDGE"	Settings	GSM/EDGE settings	*.gsm
	Slot	User-defined slot data	*.gsm_slu
	Frame	User-defined frame data	*.gsm_fu
	Slot	Higher symbol rate slot	*.gsm_hslu
	Frame	Higher symbol rate frame	*.gsm_hfu
"Bluetooth"	Bluetooth Settings	Complete setting of the Bluetooth menu	*.bto
"TETRA"	TETRA Settings	Complete setting of the TETRA menu	*.tetra
"3GPP FDD"	Settings	Complete setting of the 3GPP (FDD) menu	*.3g
	Settings	Channel coding enhanced DPCH channels (downlink)	*.3g_ccod_dl_s
	Settings	Channel coding enhanced DPDCH channels (uplink)	*.3g_ccod_ul
"CDMA2000"	Settings	Complete setting of the CDMA2000 menu	*.cdma2k
"TD-SCDMA2000"	Settings	Complete setting of the TD-SCDMA2000 menu	*.tdscdma
	Settings	Test Model for TD-SCDMA2000	*.tdtmd
1xEV-DO	Settings	Complete setting of the 1xEV-DO menu	*.evdo
"IEEE 802.11 WLAN"	Settings	Complete setting of the IEEE 802.11 WLAN menu	*.wlan
"IEEE 802.11 n WLAN"	Settings	Complete setting of the IEEE 802.11n WLAN menu	*.wlann
	Settings	Beamforming data	*.bmf
"IEEE 802.16 WiMAX"	Settings	Complete setting of the IEEE 802.16 WiMAX menu	*.wimax
"EUTRA/LTE"	Settings	Complete setting of the EUTRA/LTE menu	*.eutra
	Settings	TDD Settings	*.lte_tdd
	Settings	User-defined IQ-File	*.iqw
"GPS"	Settings	Complete setting of the GPS/A-GPS menu	*.gps

Function/Digital Standard	List type	Contents	File suffix
	Settings	GPS Almanac Settings	*.txt *.alm *.al3
	Settings	GPS Waypoints File	*.txt
	Settings	GPS Generated Almanac File	*rs_al *.rs_yuma
	Settings	GPS Ionospheric File	*.rs_ion
	Settings	GPS Navigation Data	*.rs_nav
	Settings	GPS UTC File	*.rs_utc *.rs_acq
"FM-Stereo"	Settings	Complete setting of the FM-Stereo menu	*.fmstereo
	Settings	FM-Stereo Group Type Settings	*.fm_gt
	Settings	FM-Stereo Group Hex Type Settings	*.fm_ghex
	Waveform File	Waveform File	*.wav
"Sirius"	Settings	Complete setting of the Sirius menu	*.sirius
"XM-Radio"	Settings	Complete setting of the XM-Radio menu	*.xmradio
	Settings	XM-Radio TWTA Data	*.twta
"DVB"	Settings	Complete setting of the DVB menu	*.dvb
	Settings	DVB Transport Stream	*.gts *.ts *.trp
"DAB/T-DMB"	Settings	Complete setting of the DAB/T-DMB menu	*.dab
	Settings	DAB ETI Files	*.eti *.xeti
NFC	Settings	Complete setting of the NFC menu	*.nfc

### 7.13.3 Examples

In these examples, the current instrument setting is stored in the file `test1.savrcl` in the directory `D:\user\`.

#### Storing and Loading Current Settings

1. Store the current setting in an intermediate memory with the number 4. This setting can be called using command `*RCL` and the associated number of the memory, for example `*RCL 4`.  
`*SAV 4`

2. To store the settings in a file in a specific directory, specify the complete path.  
MMEM:STOR:STAT 4, "D:\user\test.savrcl"
3. To store the settings in a file in the default drive, set the default drive and specify only the file name.  
MMEM:MSIS 'D:\user\'\*SAV 4  
MMEM:STOR:STAT 4, "test.savrcl"
4. Load the file `test.savrcl` in the user directory.  
MMEM:LOAD:STAT 4, 'D:\user\test.savrcl'
5. Activate the instrument setting of the file `test.savrcl`.  
\*RCL 4

### Working with Files and Directories

1. Read out all files in the specified directory.  
MMEM:CAT? 'E:\user'  
  
Response: 127145265,175325184,"test,DIR,0","temp,DIR,0",  
"readme.txt,ASC,1324","state.savrcl,STAT,5327",  
"waveform.wv,BIN,2342"  
  
the directory `E:\user` contains the subdirectories `test` and `temp` as well as the files `readme.txt`, `state.savrcl` and `waveform.wv` which have different file types.  
  
**Tip:** To query only the subdirectories of the current or specified directory, perform:  
MMEM:DCAT? 'E:\user'  
Response: 'test', 'temp'  
  
To query only the number of subdirectories in the current or specified directory, perform:  
MMEM:DCAT:LENG? 'E:\user'  
Response: 2
2. To query the number of files in the current or specified directory, perform:  
MMEM:CAT:LENG? 'E:\user'  
Response: 3
3. Create a new subdirectory for mass memory storage in the specified directory.  
MMEM:MDIR 'E:\new'
4. Copy the file `state` to a new file.  
MMEM:COPY 'D:\user\state.savrcl', 'E:\new'
5. Rename the file `state`.  
MMEM:MOVE 'state.savrcl', 'state\_new.savrcl'
6. Remove the `test` directory.  
MMEM:RDIR 'E:\test'

### 7.13.4 Remote Control Commands

:MMEMory:CATalog?	488
:MMEMory:CATalog:LENGth?	488
:MMEMory:CDIRectory	489
:MMEMory:COPI	489
:MMEMory:DATA	490
:MMEMory:DCATalog?	490
:MMEMory:DCATalog:LENGth?	491
:MMEMory:DELeTe	491
:MEMory:HFRee?	491
:MMEMory:LOAD:STATe	492
:MMEMory:MDIRectory	492
:MMEMory:MOVE	492
:MMEMory:MSIS	493
:MMEMory:RDIRectory	493
:MMEMory:STORe:STATe	493

---

#### :MMEMory:CATalog? <path>

Returns the content of a particular directory.

#### Query parameters:

<path>	string
	String parameter to specify the directory. If you leave out the path, the command returns the contents of the directory selected with <code>:MMEMory:CDIRectory</code> . The path may be relative or absolute.

#### Return values:

<UsedDiskSpace>	Byte size of all files in the directory.
<FreeDiskSpace>	Remaining disk space in bytes.
<FileInfo>	<NameFileN>,<SuffixFileN>,<SizeFileN> List of files, separated by commas
	<b>&lt;NameFileN&gt;</b> Name of the file.
	<b>&lt;SuffixFileN&gt;</b> Type of the file. Possible suffixes are: ASCii, BINary, DIRectory
	<b>&lt;SizeFileN&gt;</b> Size of the file in bytes.

**Example:** See "[Working with Files and Directories](#)" on page 487.

**Usage:** Query only

**Manual operation:** See "[Directory, File List and File Name](#)" on page 169

---

#### :MMEMory:CATalog:LENGth? <Path>

Returns the number of files in the current or in the specified directory.



**Query parameters:**

<Path> string  
String parameter to specify the directory. If the directory is omitted, the command queries the content of the current directory, queried with `:MMEMory:CDIRectory` command.

**Return values:**

<FileCount> integer  
Number of files.

**Example:** See "[Working with Files and Directories](#)" on page 487.

**Usage:** Query only

**:MMEMory:CDIRectory** <Directory>

Changes the default directory for mass memory storage. The directory is used for all subsequent `MMEM` commands if no path is specified with them.

**Parameters:**

<Directory> <directory\_name>  
String containing the path to another directory. The path can be relative or absolute.  
To change to a higher directory, use two dots '..'.

**Example:** See "[Working with Files and Directories](#)" on page 487.

**Usage:** SCPI confirmed

**Manual operation:** See "[Directory, File List and File Name](#)" on page 169

**:MMEMory:COPY** <SourceFile>[,<DestinationFile>]

Copies an existing file to a new file. Instead of just a file, this command can also be used to copy a complete directory together with all its files.

**Setting parameters:**

<SourceFile> string  
String containing the path and file name of the source file

<DestinationFile> string  
String containing the path and name of the target file. The path can be relative or absolute.  
If <DestinationFile> is not specified, the <SourceFile> is copied to the current directory, queried with the `:MMEMory:CDIRectory` command.

**Note:** Existing files with the same name in the destination directory are overwritten without an error message.

**Example:** See "[Working with Files and Directories](#)" on page 487.

**Usage:** Setting only  
SCPI confirmed

**Manual operation:** See "Copy " on page 175

---

**:MMEMory:DATA** <Filename>, <BinaryBlock>

**:MMEMory:DATA?** <Filename>

The setting command writes the block data <BinaryBlock> to the file identified by <Filename>. Set the GPIB-bus terminator to `EOI` to ensure correct data transfer.

The query command transfers the specified file from the instrument to the GPIB-bus and then on to the controller. It is important to ensure that the intermediate memory on the controller is large enough to take the file. The setting for the GPIB-bus terminator is irrelevant.

**Tip:** Use this command to read/transfer stored instrument settings or waveforms directly from/to the instrument.

**Parameters:**

<BinaryBlock>      #<number><length\_entry><data>  
 #: Hash sign; always comes first in the binary block  
 <number>: the first digit indicates how many digits the subsequent length entry has  
 <length\_entry>: indicates the number of subsequent bytes  
 <data>: binary block data for the specified length.  
 For files with a size with more than 9 digits (Gigabytes) the instrument allows the syntax # (<Length>), where <Length> is the file size in decimal format.

**Parameters for setting and query:**

<Filename>      string  
 String parameter to specify the name of the file.

**Example:**      `MMEMory:DATA 'D:\user\test.txt',#15hallo`  
 Writes the block data to the file `test.txt`.  
 The digit 1 indicates a length entry of 1 digit; the digit 5 indicate a length of the binary data (`hallo`) in bytes.  
`MMEMory:DATA? 'D:\user\test.txt'`  
 sends the data of the file `test.txt` from the instrument to the controller in the form of a binary block.  
 Response: `#15hallo`

**Usage:**      SCPI confirmed

---

**:MMEMory:DCATalog?** <path>

Returns the subdirectories of a particular directory.

**Query parameters:**

<path>      String parameter to specify the directory. If the directory is omitted, the command queries the content of the current directory, queried with `:MMEMory:CDIRectory` command.

**Return values:**

<Catalog> <file\_entry>  
Names of the subdirectories separated by colons. The first two strings are related to the parent directory.

**Example:** See ["Working with Files and Directories"](#) on page 487.

**Usage:** Query only

**:MMEemory:DCATalog:LENGth? [<Path>]**

Returns the number of subdirectories in the current or specified directory.

**Query parameters:**

<Path> String parameter to specify the directory. If the directory is omitted, the command queries the contents of the current directory, to be queried with [:MMEemory:CDIRectory](#) command.

**Return values:**

<DirectoryCount> integer  
Number of parent and subdirectories.

**Example:** See ["Working with Files and Directories"](#) on page 487.

**Usage:** Query only

**:MMEemory:DELeTe <Filename>**

Removes a file from the specified directory.

**Setting parameters:**

<Filename> string  
String parameter to specify the name and directory of the file to be removed.

**Example:** See ["Working with Files and Directories"](#) on page 487.

**Usage:** Event  
SCPI confirmed

**Manual operation:** See ["Cut"](#) on page 175

**:MEMory:HFRee?**

Returns the used and available memory in Kb.

**Return values:**

<TotalPhysMemKb> integer  
Total physical memory.

<ApplicMemKb> integer  
Application memory.

<HeapUsedKb>	integer Used heap memory.
<HeapAvailableKb>	integer Available heap memory.
<b>Usage:</b>	Query only

#### **:MMEMory:LOAD:STATe** <SavRclStateNumb>, <file\_name>

Loads the specified file stored under the specified name in an internal memory.

After the file has been loaded, the instrument setting must be activated using an \*RCL command.

##### **Setting parameters:**

<SavRclStateNumb> Determines to the specific <number> to be used with the \*RCL command, e.g. \*RCL 4.

<file\_name> String parameter to specify the file name with extension \*.savrcl.

**Example:** See ["Storing and Loading Current Settings"](#) on page 486.

**Usage:** Setting only

**Manual operation:** See ["Recall"](#) on page 171

#### **:MMEMory:MDIRECTory** <Directory>

Creates a subdirectory for mass memory storage in the specified directory. If no directory is specified, a subdirectory is created in the default directory. This command can also be used to create a directory tree.

##### **Setting parameters:**

<Directory> string  
String parameter to specify the new directory.

**Example:** See ["Working with Files and Directories"](#) on page 487.

**Usage:** Event

**Manual operation:** See ["Create New Directory"](#) on page 175

#### **:MMEMory:MOVE** <SourceFile>, <DestinationFile>

Moves an existing file to a new location or, if no path is specified, renames an existing file.

##### **Setting parameters:**

<SourceFile> string  
String parameter to specify the name of the file to be moved.

<DestinationFile> string  
String parameters to specify the name of the new file.

**Example:** See ["Working with Files and Directories"](#) on page 487.

**Usage:** Event  
SCPI confirmed

**Manual operation:** See ["Rename "](#) on page 175

**:MMEMory:MSIS <Msis>**

Defines the drive or network resource (in the case of networks) for instruments with windows operating system, using `msis` (MSIS = Mass Storage Identification String).

This setting applies to all `MMEMory` commands that do not explicitly specify the drive.

**Parameters:**

<Msis> string  
\*RST: D:\

**Example:** See ["Storing and Loading Current Settings"](#) on page 486.

**Usage:** SCPI confirmed

**:MMEMory:RDIRectory <Directory>**

Removes an existing directory from the mass memory storage system. If no directory is specified, the subdirectory with the specified name is deleted in the default directory.

**Setting parameters:**

<Directory> string  
String parameter to specify the directory to be deleted.

**Example:** See ["Working with Files and Directories"](#) on page 487.

**Usage:** Event

**:MMEMory:STORe:STATe <savrcl\_state\_nr>, <file\_name>**

Stores the current instrument setting in the specified file.

The instrument setting must first be stored in an internal memory with the same number using the common command `*SAV`.

**Setting parameters:**

<savrcl\_state\_nr> Corresponds to the specific <number> defined with the `*SAV` command, e.g. `*SAV 4`.

<file\_name> String parameter to specify the file name with extension `*.savrcl`.

**Example:** See ["Storing and Loading Current Settings"](#) on page 486.

**Usage:** Event

**Manual operation:** See "Save" on page 169

## 7.14 OUTPut Subsystem

The `OUTPut` system contains the commands which set the properties of the USER connector.

In two-path instruments with a second path, the properties can be set separately and independently for the two outputs A and B.

<code>:OUTPut:BLANK:POLarity</code> .....	494
<code>:OUTPut:USER&lt;ch&gt;:SOURce</code> .....	494

---

### `:OUTPut:BLANK:POLarity` <Polarity>

The command sets the polarity of the No Signal (Blank) Marker.

**Parameters:**

<Polarity>            `NORMal` | `INVerted`  
 \*RST:                `NORMal`

**Example:**            `OUTP:BLAN:POL NORM`

**Manual operation:** See "Polarity (No Signal Marker)" on page 154

---

### `:OUTPut:USER<ch>:SOURce` <Source>

The command selects the signal for the specified USER interface.

Some signals which can be applied at the USER interface are permanently assigned and some are assigned using a dedicated command (e.g. `OUTP:CW:SOURce` for the CW control signal).

An example of permanently assigned signal is the LEV-ATT control signal of Path B.

The general purpose input (`GPINput`) is available for USER interfaces 1 and 2 only.

**Parameters:**

<Source>            `AMARk4` | `BMARK4` | `ACW` | `BCW` | `ABLank` | `BBLank` | `AHOP` |  
`BHOP` | `BBITclock` | `BSYMBOLclock` | `BATTenuator` | `BBURst` |  
`ATRig` | `BTRig` | `GPINput`  
 \*RST:                `USER1 = AMARker4`; `USER 2 = ACW`; `USER 3 =`  
`ABLank`; `USER 4 = ATRig`

**Example:**            `OUTP:USER2 AMAR`  
 causes the marker signal to be output at the USER2 pin of the AUX I/O interface.  
`OUTP:CLOC:MODE SYMB`  
 specifies that the internally generated clock pulse is a symbol clock pulse.  
`OUTP:CLOC:STAT ON`  
 activates output of the symbol clock pulse at the USER2 pin

**Options:** Signals of path B (e.g. BMArker4) are selectable only with second option R&S AMU-B9/10/11

**Manual operation:** See "User Connector Signal" on page 154

## 7.15 SOURce Subsystem

The SOURce subsystem contains the commands for configuring the digital and analog signals.

### SOURce<hw>

For one-path instruments, the keyword SOURce is optional and can be omitted.

The numeric suffix to SOURce distinguishes between multicarrier generation for path A and path B in the case of two-path instruments:

- SOURce[1] = Path A  
The keyword SOURce is optional and can be omitted.
  - SOURce2 = Path B  
The keyword SOURce is mandatory, that means the command must contain the keyword with suffix 2.
- |                                     |     |
|-------------------------------------|-----|
| • SOURce:AWGN Subsystem.....        | 495 |
| • SOURce:BB Subsystem.....          | 504 |
| • SOURce:BBIN Subsystem.....        | 627 |
| • SOURce:INPut Subsystem.....       | 636 |
| • SOURce:IQ:OUTput Subsystem.....   | 638 |
| • SOURce:PATH Subsystem.....        | 654 |
| • SOURce:ROSCillator Subsystem..... | 654 |

### 7.15.1 SOURce:AWGN Subsystem

The SOURce:AWGN subsystem contains the commands for setting the noise generator.

These commands are available in instrument equipped with the option R&S AMU-K62 (Additive White Gaussian Noise).

[SOURce<hw>]:AWGN:BRATe.....	496
[SOURce<hw>]:AWGN:BWIDth.....	496
[SOURce<hw>]:AWGN:BWIDth:NOISe?.....	497
[SOURce<hw>]:AWGN:BWIDth:RATio.....	497
[SOURce<hw>]:AWGN:DISP:ORESults.....	497
[SOURce<hw>]:AWGN:ENRatio.....	498
[SOURce<hw>]:AWGN:FREQuency:RESult?.....	498
[SOURce<hw>]:AWGN:FREQuency:TARGet.....	499
[SOURce<hw>]:AWGN:MODE.....	499
[SOURce<hw>]:AWGN:POWEr:CARRier.....	500
[SOURce<hw>]:AWGN:POWEr:MODE.....	500
[SOURce<hw>]:AWGN:POWEr:NOISe.....	501

<code>[SOURce&lt;hw&gt;]:AWGN:POWer:NOISe:TOTal?</code> .....	501
<code>[SOURce&lt;hw&gt;]:AWGN:POWer:SUM?</code> .....	502
<code>[SOURce&lt;hw&gt;]:AWGN:POWer:SUM:PEP?</code> .....	502
<code>[SOURce&lt;hw&gt;]:AWGN:SNRatio</code> .....	503
<code>[SOURce&lt;hw&gt;]:AWGN:STATe</code> .....	503

---

### `[SOURce<hw>]:AWGN:BRATe <BRate>`

Sets the bit rate which is used for calculation of bit energy to noise power ratio from carrier/noise ratio for Digital Standard signals.

For "Custom Digital Mod" signals, the bit rate which is used for calculation can be queried with this command.

Valid units are bps, kbps and mabps as well as b/s, kb/s and mab/s.

#### Parameters:

<code>&lt;BRate&gt;</code>	float
Range:	400 bps to 250E6 bps
Increment:	0.001
*RST:	100000

#### Example:

```
SOURce1:AWGN:BRATe?
queries the bit rate which is used for calculation of the Eb/NO
value from the C/N value.
```

#### Options:

R&S AMU-B13 and -K62; SOURce2 only with a second option R&S AMU-B13 and at least one of the options R&S AMU-B9/10/11 or -B17

**Manual operation:** See "[Bit Rate - AWGN](#)" on page 230

---

### `[SOURce<hw>]:AWGN:BWIDth <BWidth>`

Sets the system bandwidth. The noise signal at the level which corresponds to the specified carrier/noise ratio is generated in the bandwidth specified here.

This command is available for modes Additive Noise and Noise Only (`SOUR:AWGN:MODE ADD|ONLY`).

#### Parameters:

<code>&lt;BWidth&gt;</code>	float
Range:	1000 to 80E6
Increment:	100
*RST:	3.84E6

#### Example:

```
SOURce:AWGN:MODE ADD
SOURce:AWGN:BWIDth 10 MHz
sets a system bandwidth of 10 MHz.
```

**Manual operation:** See "[System Bandwidth - AWGN](#)" on page 228



**[[:SOURce<hw>]:AWGN:BWIDth:NOISe?**

This command is available for modes In Additive Noise and Noise Only (SOUR:AWGN:MODE ADD|ONLY) modes, queries the real noise bandwidth.

**Return values:**

<Noise> float  
 Range: 0 to 200E6  
 Increment: 100  
 \*RST: 0

**Example:** AWGN:BWID:NOIS?  
 queries the noise bandwidth.

**Usage:** Query only

**Options:** R&S AMU-B13 and -K62; SOURce2 only with a second option R&S AMU-B13 and at least one of the options R&S AMU-B9/10/11 or -B17

**Manual operation:** See "[Noise Bandwidth - AWGN](#)" on page 229

**[[:SOURce<hw>]:AWGN:BWIDth:RATio <Ratio>**

In Additive Noise and Noise Only (SOUR:AWGN:MODE ADD|ONLY) modes, sets the ratio of minimum real noise bandwidth to system bandwidth.

The overall bandwidth is calculated as follows and may not exceed the total bandwidth specified in the data sheet:

Overall Bandwidth = System BW x Min Noise/System BW Ratio

**Parameters:**

<Ratio> float  
 Range: 1 to Max  
 Increment: 0.1  
 \*RST: 1

**Example:** AWGN:BWID:RAT 2  
 sets a minimum noise/system bandwidth ratio of 2.

**Options:** R&S AMU-B13 and -K62; SOURce2 only with a second option R&S AMU-B13 and at least one of the options R&S AMU-B9/10/11 or -B17

**Manual operation:** See "[Minimum Noise/System Bandwidth Ratio - AWGN](#)" on page 228

**[[:SOURce<hw>]:AWGN:DISP:ORESults <OResults>**

(requires option R&S AMU-B18, Baseband Digital I/Q Out)

In additive Noise and Noise Only (`SOUR:AWGN:MODE ADD|ONLY`) modes and for Display Mode set to Baseband (`AWGN:DISP:MODE BB`), selects the display of output results for the analog (DACIF) or the digital (BBOU) signal path.

**Parameters:**

<OResults>            ANALog | DIGital  
 \*RST:                ANALog

**Example:**

`SOURce:AWGN:MODE ONLY`  
 activates the generation of a pure noise for path A.  
`SOURce:AWGN:DISP:MODE BB`  
 sets the display mode  
`SOURce:AWGN:DISP:OREsults DIGital`  
 displays the output results of the digital signal of path A.

**Options:**

R&S AMU-B13 and -K62, Digital Output only with option R&S AMU-B18, SOURce2 only with a second option R&S AMU-B13 and at least one of the options R&S AMU-B9/10/11 or -B17

**Manual operation:** See "[Display Output Results For - AWGN](#)" on page 229

**[:SOURce<hw>]:AWGN:ENRatio <EnRatio>**

In Additive Noise mode, sets the ratio of bit energy to noise power density.

For **Digital Standard** signals, the bit rate used for calculation of  $E_b/N_0$  value from C/N value is defined with command `SOUR:AWGN:BRAT`.

For **Custom Digital Mod** signals the bit rate used for calculation of  $E_b/N_0$  value from C/N value is determined by the selected standard (`SOURce:BB:DM:STANDARD`) and cannot be changed.

**Parameters:**

<EnRatio>            float  
 Range:               -50 to depends on hardware  
 Increment:          0.01  
 \*RST:                15.84  
 Default unit:        dB

**Example:**

`AWGN:ENR 10`  
 sets a ratio of bit energy to noise power density of 10 dB

**Options:**

R&S AMU-B13 and -K62; SOURce2 only with a second option R&S AMU-B13 and at least one of the options R&S AMU-B9/10/11 or -B17

**Manual operation:** See " [\$E\_b/N\_0\$  - AWGN](#)" on page 231

**[:SOURce<hw>]:AWGN:FREQuency:RESult?**

In CW inerferer mode, queries the actual frequency of the sine.

The actual frequency may differ from the desired frequency, since the resolution is limited to 0.7 Hz.

**Return values:**

<Result> float  
 Range: -40E6 to 40E6  
 Increment: 0.01  
 \*RST: 0

**Example:** `AWGN:FREQ:RES?`  
 queries the actual frequency of the interfering sine

**Usage:** Query only

**Options:** R&S AMU-B13 and -K62; SOURce2 only with a second option R&S AMU-B13 and at least one of the options R&S AMU-B9/10/11 or -B17

**Manual operation:** See "[Resulting CW Frequency - AWGN](#)" on page 229

**[:SOURce<hw>]:AWGN:FREQuency:TARGet <Target>**

Sets the desired frequency of the sine in `AWGN:MODE CW` mode.

The resulting frequency may differ from the desired frequency because of the limited frequency resolution of 0.7 Hz.

**Parameters:**

<Target> float  
 Range: -40E6 to 40E6  
 Increment: 0.01  
 \*RST: 0

**Example:** `AWGN:FREQ:TARG 2kHz`  
 sets a frequency of 2 kHz for the interfering sine.

**Options:** R&S AMU-B13 and -K62; SOURce2 only with a second option R&S AMU-B13 and at least one of the options R&S AMU-B9/10/11 or -B17

**Manual operation:** See "[Target CW Frequency - AWGN](#)" on page 229

**[:SOURce<hw>]:AWGN:MODE <Mode>**

Selects the mode for generating the interfering signal.

**Parameters:**

<Mode> ONLY | ADD | CW

**ADD**

The AWGN noise signal is added to the baseband signal.

**ONLY**

The pure AWGN noise signal is modulated to the carrier. The connection to the baseband is interrupted.

**CW**

The sine interfering signal is added to the baseband signal.

\*RST: ADD

**Example:**

SOURce:AWGN:MODE ONLY

SOURce:AWGN:STATE ON

selects the generation of a pure noise and activates it

**Options:**

R&S AMU-B13 and -K62; SOURce2 only with a second option R&S AMU-B13 and at least one of the options R&S AMU-B9/10/11 or -B17

**Manual operation:** See "[Mode - AWGN](#)" on page 228

**[:SOURce<hw>]:AWGN:POWer:CARRier <Carrier>**

available for Additive Noise and CW Interferer (SOUR:AWGN:MODE ADD|CW) modes

Sets/queries the signal power. The power of the noise signal is derived from the entered S/N value.

**Parameters:**

<Carrier> float

Increment: 0.01

\*RST: 0

Default unit: dBm

**Example:**

AWGN:POW:CARR?

queries the carrier power

**Options:**

R&S AMU-B13 and -K62; SOURce2 only with a second option R&S AMU-B13 and at least one of the options R&S AMU-B9/10/11 or -B17

**Manual operation:** See "[Carrier Power](#)" on page 231

**[:SOURce<hw>]:AWGN:POWer:MODE <Mode>**

In Additive Noise (SOUR:AWGN:MODE ADD) mode, selects the mode for setting the noise power.

**Parameters:**

&lt;Mode&gt; CN | SN | EN

**CN|SN**

The noise power is set on the basis of the value entered for the carrier/noise or signal/noise ratio

(SOURce:AWGN:CNRatio|SNRatio).

**EN**

The noise power is set on the basis of the value entered for the ratio of bit energy to noise power density (AWGN:ENR).

\*RST: CN|SN

**Example:**

SOUR:AWGN:POW:MODE CN

the noise power is set on the basis of the value entered for the carrier/noise ratio (AWGN:CNR).

**Options:**

R&S AMU-B13 and -K62; SOURce2 only with a second option R&S AMU-B13 and at least one of the options R&S AMU-B9/10/11 or -B17

**Manual operation:** See ["Set Power via - AWGN "](#) on page 230

**[:SOURce<hw>]:AWGN:POWer:NOISe <Noise>**

Sets or queries the noise power in the system bandwidth depending on the selected mode:

- SOUR:AWGN:MODE ADD|CW  
Queries the noise/interferer power which is derived from the entered S/N value.
- "Noise Only" mode  
The command sets the noise power.

**Parameters:**

&lt;Noise&gt; float

Increment: 0.01

Default unit: dBm

**Example:**

SOURce:AWGN:POWer:NOISe?

queries the noise power in the system bandwidth.

Response: 10

the noise power in the system bandwidth is 10 dBm.

**Options:**

R&S AMU-B13 and -K62; SOURce2 only with a second option R&S AMU-B13 and at least one of the options R&S AMU-B9/10/11 or -B17

**Manual operation:** See ["Noise Power \(System Bandwidth\) / Interferer Power"](#) on page 231

**[:SOURce<hw>]:AWGN:POWer:NOISe:TOTal?**

In Additive Noise and CW Interferer (SOUR:AWGN:MODE ADD|CW) modes, queries the noise power in the total bandwidth.

**Tip:** Use the command `[ :SOURce<hw> ] :AWGN:DISP:OREsults` to define the analog or digital signal path before.

**Return values:**

<Total> float  
 Range: -145 to 20  
 Increment: 0.01  
 \*RST: -30

**Example:**

`SOURce:AWGN:POWer:NOISe:TOTal?`  
 queries the noise power in the total bandwidth.  
 Response: 15  
 the noise power in the total bandwidth is 15 dBm.

**Usage:** Query only

**Options:** R&S AMU-B13 and -K62; SOURce2 only with a second option R&S AMU-B13 and at least one of the options R&S AMU-B9/10/11 or -B17

**Manual operation:** See "[Noise Power \(Total Bandwidth\) - AWGN](#)" on page 232

**[ :SOURce<hw> ] :AWGN:POWer:SUM?**

In Additive Noise and CW Interferer (`SOUR:AWGN:MODE ADD|CW`) modes, queries the overall power of the noise signal plus useful signal.

**Tip:** Use the command `[ :SOURce<hw> ] :AWGN:DISP:OREsults` to define the analog or digital signal path before.

**Return values:**

<Sum> float  
 Range: -145 to 20  
 Increment: 0.01  
 \*RST: 0

**Example:**

`SOURce:AWGN:POWer:SUM?`  
 queries the overall power of the noise signal plus useful signal.

**Usage:** Query only

**Options:** R&S AMU-B13 and -K62; SOURce2 only with a second option R&S AMU-B13 and at least one of the options R&S AMU-B9/10/11 or -B17

**Manual operation:** See "[Carrier + Noise Power / Signal + Noise Power \(System Bandwidth\) / Carrier + Interferer Power / Signal + Interferer Power](#)" on page 232

**[ :SOURce<hw> ] :AWGN:POWer:SUM:PEP?**

In Additive Noise and CW Interferer (`SOUR:AWGN:MODE ADD|CW`) modes, queries the peak envelope power of the overall signal comprised of noise signal plus useful signal.

**Tip:** Use the command `[ :SOURce<hw> ]:AWGN:DISP:OREsults` to define the analog or digital signal path before.

**Return values:**

<Pep> float  
 Range: -145 to 20  
 Increment: 0.01  
 \*RST: 0

**Example:** `SOURce:AWGN:POWer:SUM:PEP?`  
 queries the peak envelope power of the overall signal.

**Usage:** Query only

**Options:** R&S AMU-B13 and -K62; SOURce2 only with a second option R&S AMU-B13 and at least one of the options R&S AMU-B9/10/11 or -B17

**Manual operation:** See "[Carrier + Noise PEP / Signal + Noise PEP \(Total Bandwidth\) / Carrier + Interferer PEP / Signal + Interferer PEP](#)" on page 232

**[ :SOURce<hw> ]:AWGN:SNRatio <SnRatio>**

Available for modes "Additive Noise" and "CW Interferer" (`SOUR:AWGN:MODE ADD|CW`)

This command sets the signal/noise ratio or the signal / interferer ratio. The value range depends on the selected AWGN mode (`AWGN:MODE ADD|ONLY|CW`).

**Parameters:**

<SnRatio> float  
 Increment: 0.001  
 \*RST: 0  
 Default unit: dB

**Example:** `AWGN:SNR 10`  
 sets a signal/noise ratio of 10 dB.

**Options:** R&S AMU-B13 and -K62; SOURce2 only with a second option R&S AMU-B13 and at least one of the options R&S AMU-B9/10/11 or -B17

**Manual operation:** See "[Carrier/Noise Ratio / Signal/Noise Ratio](#)" on page 230

**[ :SOURce<hw> ]:AWGN:STATe <State>**

Activates or deactivates the white noise (AWGN = Averaged White Gaussian Noise).

Use the command `[ :SOURce<hw> ]:AWGN:MODE` to define the mode the AWGN generator is working in.

**Parameters:**

<State> 0 | 1 | OFF | ON  
 \*RST: 0

**Example:**

SOURce:AWGN:STATe ON

**Options:**

R&S AMU-B13 and -K62; SOURce2 only with a second option  
 R&S AMU-B13 and at least one of the options R&S AMU-  
 B9/10/11 or -B17

**Manual operation:** See "State - AWGN" on page 228

## 7.15.2 SOURce:BB Subsystem

This subsystem contains all commands for digital signal generation. It is divided into several subsystems which are described separately.

### OUTPut<ch>

The numeric suffix to OUTPut distinguishes between the available markers.

### EXTernal<ch>

The numeric suffix to EXTernal distinguishes between the available external trigger inputs.

- [SOURce:BB Subsystem General Commands](#)..... 504
- [SOURce:BB:ARB Subsystem](#)..... 506
- [SOURce:BB:DM Subsystem](#)..... 556
- [SOURce:BB:GRAPhics Subsystem](#)..... 595
- [SOURce:BB:IMPairment Subsystem](#)..... 598
- [SOURce:BB:MCCW Subsystem](#)..... 600
- [SOURce:BB:MEASurement Subsystem](#)..... 621
- [SOURce:BB:POWer Subsystem](#)..... 625
- [SOURce:BB:PROGress Subsystem General Commands](#)..... 626

### 7.15.2.1 SOURce:BB Subsystem General Commands

The following section describes the commands for setting the frequency shift and the phase offset for the signal at the "Baseband" block output.

<a href="#">[:SOURce]:BB:PATH:COUNT?</a> .....	504
<a href="#">[:SOURce&lt;hw&gt;]:BB:FOFFset</a> .....	505
<a href="#">[:SOURce&lt;hw&gt;]:BB:PGAin</a> .....	505
<a href="#">[:SOURce&lt;hw&gt;]:BB:POFFset</a> .....	505
<a href="#">[:SOURce&lt;hw&gt;]:BB:ROUTE</a> .....	506

---

#### **[:SOURce]:BB:PATH:COUNT?**

The command queries the number of installed baseband paths.



**Return values:**

<Count> integer

**Example:**

PATH:COUN?

queries the number of baseband paths.

Response:1

The instrument is equipped with one baseband path.

**Usage:**

Query only

**Manual operation:** See "[Signal Routing](#)" on page 239

**[:SOURce<hw>]:BB:FOFFset <FOffset>**

Sets the frequency offset for the baseband signal. The offset affects the signal on the baseband block output. It shifts the useful baseband signal in the center frequency.

**Parameters:**

<FOffset> float  
Increment: 0.01  
\*RST: 0

**Example:**

BB:FOFF 2MHZ

sets a frequency offset of 2 MHz.

**Manual operation:** See "[Frequency Offset](#)" on page 237

**[:SOURce<hw>]:BB:PGAin <PGain>**

The command sets the relative path gain for the selected baseband signal compared to the baseband signals of the other baseband sources (second path or external baseband). The gain affects the signal on the "baseband block" output.

**Parameters:**

<PGain> float  
Range: -50 to 50  
Increment: 1E-3  
\*RST: 0

**Example:**

BB:PGA 3dB

sets a relative path gain of 3 dB for the baseband signal of path A compared to the baseband signal of path B.

**Manual operation:** See "[Path Gain](#)" on page 239

**[:SOURce<hw>]:BB:POFFset <POffset>**

The command sets the relative phase offset for the selected baseband signal compared to the baseband signals of the other baseband sources (second path or external baseband).

The phase offset affects the signal on the "baseband block" output.

**Parameters:**

<POffset> float  
 Range: 0 to 359.9  
 Increment: 0.01  
 \*RST: 0  
 Default unit: DEG

**Example:**

```
BB:POFF 0.5DEG
```

sets a relative phase offset of 0.5 DEG for the baseband signal

**Manual operation:** See "[Phase Offset](#)" on page 238

**[:SOURce<hw>]:BB:ROUTe <Route>**

The command selects the signal route for the baseband signal of a two-path instrument.

**Parameters:**

<Route> A | B | AB

**A**

The baseband signal is introduced into path A. The signals from both paths are summed if necessary.

**B**

The baseband signal is introduced into path B. The signals from both paths are summed if necessary.

**AB**

The baseband signal is introduced into path A and path B. The signals from both paths are summed if necessary.

\*RST: A

**Example:**

```
SOUR2:BB:ROUT A
```

the baseband signal of path B is introduced into path A.

**Manual operation:** See "[Signal Routing](#)" on page 239

**7.15.2.2 SOURce:BB:ARB Subsystem**

The ARB subsystem contains the commands for setting the ARB Generator. Settings for clock and trigger interfaces and for external outputs are entered in the `SOURce:INPut` and `SOURce:OUTput` subsystems.

Section [Chapter 7.4, "Waveform and List Format"](#), on page 432 describes the ARB waveform format and how it is used to transmit waveforms via the IEC bus.

- [Common Settings](#).....507
- [Clock Settings](#)..... 507
- [Trigger Settings](#).....509
- [Marker Settings](#).....518
- [Test Signals Settings](#)..... 521

- [SOURce:BB:ARB:MCAR Subsystem](#)..... 524
- [SOURce:BB:ARB:WAV Subsystem](#).....539
- [SOURce:BB:ARB:WSEG Subsystem](#)..... 545

### Common Settings

- [\[:SOURce<hw>\]:BB:ARbitrary:PRESet](#)..... 507
- [\[:SOURce<hw>\]:BB:ARbitrary:STATe](#).....507

#### **[:SOURce<hw>]:BB:ARbitrary:PRESet**

Sets all ARB generator parameters to their default values.

**Example:**                SOURce1:BB:ARB:PRESet

**Usage:**                Event

**Manual operation:**   See "[Set To Default](#)" on page 304

#### **[:SOURce<hw>]:BB:ARbitrary:STATe <State>**

Activates the standard and deactivates all the other digital standards and digital modulation modes in the same path.

You have to select a waveform first.

**Parameters:**

<State>                0 | 1 | OFF | ON  
 \*RST:                0

**Example:**                SOURce1:BB:ARbitrary:WAV:SElect 'wave1'  
 loads waveform file from the default directory.  
 SOURce1:BB:ARbitrary:TRIGger:SEQ RETR  
 sets trigger mode Retrigger.  
 SOURce1:BB:ARbitrary:STATe ON  
 switches on the ARB generator. The selected waveform is output straight away. A trigger event causes restart.

**Manual operation:**   See "[State \(ARB\)](#)" on page 304

### Clock Settings

- [\[:SOURce<hw>\]:BB:ARbitrary:CLOCK](#)..... 507
- [\[:SOURce<hw>\]:BB:ARbitrary:CLOCK:MODE](#).....508
- [\[:SOURce<hw>\]:BB:ARbitrary:CLOCK:MULTIplier](#).....508
- [\[:SOURce<hw>\]:BB:ARbitrary:CLOCK:SOURce](#).....509

#### **[:SOURce<hw>]:BB:ARbitrary:CLOCK <Clock>**

The command sets the clock rate in samples. Loading a waveform waveform (ARB:WAV:SEL <name>) sets the clock rate that is defined in the waveform tag 'clock'. The command subsequently changes the clock rate; see data sheet for value range.

In the case of an external clock source (selection `ARB:CLOCK:SOURce EXternal`) the clock for the external source must be entered with this command.

**Parameters:**

<Clock> float  
Increment: 0.001

**Example:**

`BB:ARB:CLOC:SOUR INT`  
selects the internal clock source for generating waveforms.  
`BB:ARB:CLOC 0.5 MHz`  
sets the clock rate to 0.5 MHz.

**Manual operation:** See ["Clock Frequency"](#) on page 306

**[ :SOURce<hw> ]:BB:ARbitrary:CLOCK:MODE <Mode>**

The command enters the type of externally supplied clock (`:BB:ARB:CLOCK:SOURce EXternal`). When `MSAMple` is used, a multiple of the sample clock is supplied via the `CLOCK` connector and the sample clock is derived internally from this. The multiplier is entered with the command `:BB:ARB:CLOCK:MULTiplier`.

For two-path instruments, the only numerical suffix allowed for `SOURce` is 1, since the external clock source is permanently allocated to path A.

**Parameters:**

<Mode> `SAMPlE | MSAMPlE`  
\*RST: `SAMPlE`

**Example:**

`BB:ARB:CLOC:MODE SAMP`  
selects clock type "Sample", i.e. the supplied clock is a sample clock.

**Manual operation:** See ["Clock Mode"](#) on page 320

**[ :SOURce<hw> ]:BB:ARbitrary:CLOCK:MULTiplier <Multiplier>**

The command specifies the multiplier for clock type "Multiple Samples" (`:BB:ARB:CLOCK:MODE MSAM`) in the case of an external clock source.

For two-path instruments, the only numerical suffix allowed for `SOURce` is 1, since the external clock source is permanently allocated to path A.

**Parameters:**

<Multiplier> integer  
Range: 1 to 64  
\*RST: 4

**Example:** `BB:ARB:CLOC:SOUR EXT`  
 selects the external clock source. The clock is supplied via the CLOCK connector.  
`BB:ARB:CLOC:MODE MSAM`  
 selects clock type Multiple Samples, i.e. the supplied clock has a rate which is a multiple of the sample rate.  
`BB:ARB:CLOC:MULT 12`  
 The multiplier for the external clock rate is 12.

**Manual operation:** See "[Sample Clock Multiplier](#)" on page 320

**[:SOURce<hw>]:BB:ARbitrary:CLOCK:SOURce <Source>**

The command selects the source for the digital modulation clock.

**Parameters:**

<Source> INTERNAL | EXTERNAL | AINTERNAL

**INTERNAL**

The internal clock reference is used.

**EXTERNAL**

The external clock reference is supplied to the connector.

\*RST: INTERNAL

**Example:** `BB:ARB:CLOC:SOUR EXT`  
 selects an external clock reference. The clock is supplied via the connector.  
`BB:ARB:CLOC:MODE SAMP`  
 enters clock type sample.

**Manual operation:** See "[Clock Source](#)" on page 319

**Trigger Settings**

<a href="#">[:SOURce&lt;hw&gt;]:BB:ARbitrary:TRIGger:ARM:EXECute</a> .....	510
<a href="#">[:SOURce&lt;hw&gt;]:BB:ARbitrary:TRIGger:EXECute</a> .....	510
<a href="#">[:SOURce&lt;hw&gt;]:BB:ARbitrary:TRIGger[:EXTernal]:SYNChronize:OUTPut</a> .....	510
<a href="#">[:SOURce&lt;hw&gt;]:BB:ARbitrary:TRIGger:OBASeband:DELay</a> .....	511
<a href="#">[:SOURce&lt;hw&gt;]:BB:ARbitrary:TRIGger:OBASeband:RDELay?</a> .....	511
<a href="#">[:SOURce&lt;hw&gt;]:BB:ARbitrary:TRIGger:OBASeband:TDELay</a> .....	512
<a href="#">[:SOURce&lt;hw&gt;]:BB:ARbitrary:TRIGger:OBASeband:INHibit</a> .....	512
<a href="#">[:SOURce&lt;hw&gt;]:BB:ARbitrary:TRIGger:OUTPut:DELay:FIXed</a> .....	512
<a href="#">[:SOURce&lt;hw&gt;]:BB:ARbitrary:TRIGger:OUTPut&lt;ch&gt;:DELay</a> .....	513
<a href="#">[:SOURce&lt;hw&gt;]:BB:ARbitrary:TRIGger:OUTPut&lt;ch&gt;:DELay:MAXimum?</a> .....	513
<a href="#">[:SOURce&lt;hw&gt;]:BB:ARbitrary:TRIGger:OUTPut&lt;ch&gt;:DELay:MINimum?</a> .....	513
<a href="#">[:SOURce&lt;hw&gt;]:BB:ARbitrary:TRIGger:RMODE?</a> .....	514
<a href="#">[:SOURce&lt;hw&gt;]:BB:ARbitrary:TRIGger:SLENgth</a> .....	514
<a href="#">[:SOURce&lt;hw&gt;]:BB:ARbitrary:TRIGger:SLUNit</a> .....	515
<a href="#">[:SOURce&lt;hw&gt;]:BB:ARbitrary:TRIGger:SMODE</a> .....	515
<a href="#">[:SOURce&lt;hw&gt;]:BB:ARbitrary:TRIGger:SOURce</a> .....	515
<a href="#">[:SOURce&lt;hw&gt;]:BB:ARbitrary:TRIGger:DELay:UNIT</a> .....	516
<a href="#">[:SOURce&lt;hw&gt;]:BB:ARbitrary:TRIGger[:EXTernal&lt;1 2&gt;]:DELay</a> .....	516

<code>[:SOURce&lt;hw&gt;]:BB:ARbitrary:TRIGger[:EXternal&lt;1 2&gt;]:TDElay</code> .....	516
<code>[:SOURce&lt;hw&gt;]:BB:ARbitrary:TRIGger[:EXternal&lt;1 2&gt;]:RDElay?</code> .....	516
<code>[:SOURce&lt;hw&gt;]:BB:ARbitrary:TRIGger[:EXternal&lt;1 2&gt;]:INHibit</code> .....	517
<code>[:SOURce&lt;hw&gt;]:BB:ARbitrary:TRIGger:SEQuence</code> .....	517

---

### `[:SOURce<hw>]:BB:ARbitrary:TRIGger:ARM:EXECute`

The command stops waveform output for trigger modes `Armed_Auto` and `Armed_Retrigger`. A subsequent internal or external trigger event restart waveform output.

**Example:**

```
BB:ARB:TRIG:SOUR INT
sets internal triggering.
BB:ARB:TRIG:SEQ ARET
sets Armed_Retrigger mode, i.e. every trigger event causes
waveform output to restart.
BB:ARB:TRIG:EXEC
executes a trigger, waveform output is started.
BB:ARB:TRIG:ARM:EXEC
waveform output is stopped.
BB:ARB:TRIG:EXEC
executes a trigger, waveform output is started again.
```

**Usage:** Event

**Manual operation:** See "[Arm](#)" on page 310

---

### `[:SOURce<hw>]:BB:ARbitrary:TRIGger:EXECute`

The command executes a trigger. The internal trigger source must be selected using the command `ARB:TRIGger:SOURce INTernal` and a trigger mode other than `AUTO` must be selected using the command `:ARB:SEQuence`.

**Example:**

```
BB:ARB:TRIG:SOUR INT
sets internal triggering.
BB:ARB:SEQ RETR
sets Retrigger mode, i.e. every trigger event causes signal out-
put to restart.
BB:ARB:TRIG:EXEC
executes a trigger.
```

**Usage:** Event

**Manual operation:** See "[Execute Trigger](#)" on page 306

---

### `[:SOURce<hw>]:BB:ARbitrary:TRIGger[:EXternal]:SYNChronize:OUTPut` <Output>

(enabled for "Trigger Source" External)

Enables/disables output of the signal synchronous to the external trigger event.

**Parameters:**

&lt;Output&gt; 0 | 1 | OFF | ON

**ON**

The signal calculation starts simultaneously with the external trigger event but because of the instrument's processing time the first samples are cut off and no signal is outputted. After elapsing of the internal processing time, the output signal is synchronous to the trigger event.

**OFF**

The signal output begins after elapsing of the processing time and starts with sample 0, i.e. the complete signal is outputted. This mode is recommended for triggering of short signal sequences with signal duration comparable with the processing time of the instrument.

\*RST: ON

**Example:**

BB:ARB:TRIG:SOUR EXT

sets external triggering.

BB:ARB:TRIG:EXT:SYNC:OUTP ON

enables synchronous output to external trigger

**Manual operation:** See "[Sync. Output to External Trigger](#)" on page 311**[[:SOURce<hw>]:BB:ARbitrary:TRIGger:OBASeband:DELay <Delay>**

Sets the trigger delay (expressed as a number of samples) for triggering by the signal from the second path (two-path instruments only).

**Parameters:**

&lt;Delay&gt; float

Range: 0 to 65535

Increment: 0.01

\*RST: 0

Default unit: sample

**Example:**

BB:ARB:TRIG:SOUR OBAS

sets for path A the internal trigger executed by the signal from the second path (path B).

BB:ARB:TRIG:DEL 200

sets a delay of 200 samples for the trigger.

**Manual operation:** See "[Trigger Delay](#)" on page 312**[[:SOURce<hw>]:BB:ARbitrary:TRIGger:OBASeband:RDELay?**

Queries the time (in seconds) a trigger event from the other path is delayed.

**Return values:**

<ObResTimeDelay> float  
 Range: 0 to 688  
 Increment: 250E-12  
 \*RST: 0

**Usage:** Query only

**Manual operation:** See "[Actual Trigger Delay](#)" on page 312

**[:SOURce<hw>]:BB:ARBitrary:TRIGger:OBASeband:TDElay <ObasTimeDelay>**

Specifies the trigger delay (in seconds) for triggering by the signal from the second path.

**Parameters:**

<ObasTimeDelay> float  
 Range: 0 to 688  
 Increment: 250E-12  
 \*RST: 0

**Manual operation:** See "[Trigger Delay](#)" on page 312

**[:SOURce<hw>]:BB:ARBitrary:TRIGger:OBASeband:INHibit <Inhibit>**

Sets the number of samples by which a restart is to be inhibited following a trigger event.

This command applies only for triggering by the second path.

**Parameters:**

<Inhibit> integer  
 Range: 0 to 67108863  
 \*RST: 0  
 Default unit: sample

**Example:**

BB:ARB:TRIG:SOUR OBAS  
 sets for path A the internal trigger executed by the signal from the second path (path B).  
 BB:ARB:TRIG:INH 200  
 sets a restart inhibit for 200 samples following a trigger event.

**Manual operation:** See "[Trigger Inhibit](#)" on page 312

**[:SOURce<hw>]:BB:ARBitrary:TRIGger:OUTPut:DELay:FIXed <Fixed>**

The command restricts the marker delay setting range to the dynamic range. In this range the delay can be set without restarting the marker and signal. If a delay is entered in setting ON but is outside this range, the maximum possible delay is set and an error message is output.

The setting always affects every marker.



**Parameters:**

<Fixed> 0 | 1 | OFF | ON  
 \*RST: 0

**Example:**

BB:ARB:TRIG:OUTP:DEL:FIX ON  
 restricts the marker signal delay setting range to the dynamic range.

**Manual operation:** See ["Fix marker delay to current range "](#) on page 319

**[:SOURce<hw>]:BB:ARbitrary:TRIGger:OUTPut<ch>:DELay <Delay>**

Sets the delay between the signal on the marker outputs and the start of the signals.

**Parameters:**

<Delay> float  
 Range: 0 to depends on other values  
 Increment: 0.001  
 \*RST: 0  
 Default unit: Symbol

**Example:**

BB:ARB:TRIG:OUTP2:DEL 16  
 sets a delay for the signal on connector MARKER 2.

**Manual operation:** See ["Marker x Delay"](#) on page 319

**[:SOURce<hw>]:BB:ARbitrary:TRIGger:OUTPut<ch>:DELay:MAXimum?**  
**[:SOURce<hw>]:BB:ARbitrary:TRIGger:OUTPut<ch>:DELay:MINimum?**

The command queries the minimum marker delay for setting :BB:ARB:TRIGger:OUTPut:DELay:FIXed ON.

**Return values:**

<Minimum> float  
 Range: 0 to 16777215  
 Increment: 1E-3  
 \*RST: 0

**Example:**

BB:ARB:TRIG:OUTP:DEL:FIX ON  
 restricts the marker signal delay setting range to the dynamic range.  
 BB:ARB:TRIG:OUTP:DEL:MIN  
 queries the minimum of the dynamic range.  
 Response: 0  
 the minimum for the marker delay setting is 0 samples.

**Usage:** Query only

**Manual operation:** See ["Current Range without Recalculation"](#) on page 319

**[:SOURce<hw>]:BB:ARbitrary:TRIGger:RMODE?**

The command queries the status of waveform output or all trigger modes with ARB on.

**Return values:**

<RMode>                    STOP | RUN

**RUN**

The waveform is output. A trigger event occurred in the triggered mode.

**STOP**

The waveform is not output. A trigger event did not occur in the triggered modes, or waveform output was stopped by the command `BB:ARB:TRIG:ARM:EXECute` (armed trigger modes only).

**Example:**

`BB:ARB:TRIG:SOUR EXT`

sets external triggering

`BB:ARB:TRIG:MODE ARET`

selects the Armed\_Retrigger mode.

`BB:ARB:TRIG:RMODE?`

queries the current status of waveform output.

Response: RUN

the waveform is output, an external trigger was executed.

**Usage:**                    Query only

**Manual operation:**    See "[Running/Stopped](#)" on page 310

**[:SOURce<hw>]:BB:ARbitrary:TRIGger:SLENgth <SLength>**

The command defines the length of the signal sequence to be output in the Single trigger mode. The unit is defined with command `SOUR:BB:ARB:TRIG:SLUNit`. It is possible to output deliberately just part of the waveform, an exact sequence of the waveform, or a defined number of repetitions of the waveform.

**Parameters:**

<SLength>                    integer

Range:                    1 to dynamic

\*RST:                    1

Default unit: sample

**Example:**

`BB:ARB:SEQ SING`

sets trigger mode Single.

`BB:ARB:TRIG:SLUN SAMP`

sets unit Samples for the entry of sequence length.

`BB:ARB:TRIG:SLEN 200`

sets a sequence length of 200 samples. The first 200 samples of the current waveform will be output after the next trigger event.

**Manual operation:**    See "[Signal Duration](#) " on page 309

**[[:SOURce<hw>]:BB:ARbitrary:TRIGger:SLUnit <SLUnit>**

The command defines the unit for the entry of the length of the signal sequence (SOUR:BB:ARB:TRIG:SLEN) to be output in the "Single" trigger mode (SOUR:BB:ARB:SEQ SING).

**Parameters:**

<SLUnit>                    SEQuence | SAMPlE  
\*RST:                    SEQuence

**Example:**

```
BB:ARB:SEQ SING
sets trigger mode Single.
BB:ARB:TRIG:SLUN SEQ
sets unit Sequence length for the entry of sequence length.
BB:ARB:TRIG:SLEN 2
sets a sequence length of 2 waveforms. The current waveforms
will be output twice after the next trigger event.
```

**Manual operation:** See ["Signal Duration Unit"](#) on page 309

**[[:SOURce<hw>]:BB:ARbitrary:TRIGger:SMODE <SMODE>**

The command selects the extended trigger mode for multi segment waveforms.

**Parameters:**

<SMODE>                    SAME | NEXT | NSEam | SEQuencer  
NSEam = Next Segment Seamless  
\*RST:                    NEXT

**Example:**

```
SOUR:BB:ARB:SEQ AUTO
selects trigger mode AUTO.
SOUR:BB:ARB:TRIG:SMOD SAME
the same segment of the waveform is output repeatedly.
```

**Manual operation:** See ["Next Segment Mode"](#) on page 313

**[[:SOURce<hw>]:BB:ARbitrary:TRIGger:SOURce <Source>**

Selects the trigger source.

**Parameters:**

<Source>                    INTernal|OBASeband|BEXTernal|EXTernal  
**INTernal**  
manual trigger or \*TRG.  
**EXTernal | BEXTernal**  
trigger signal on the TRIGGER 1/2 connector.  
**OBASeband**  
trigger signal from the other path  
\*RST:                    INTernal

**Example:**

```
SOURce1:BB:ARbitrary:TRIGger:SOURce EXTernal
sets external triggering via the TRIGGER 1 connector.
```

**Manual operation:** See ["Trigger Source"](#) on page 310

---

**[[:SOURce<hw>]:BB:ARbitrary:TRIGger:DElay:UNIT <TrigDelUnit>**

Determines the units the trigger delay is expressed in.

**Parameters:**

<TrigDelUnit>           SAMPLE | TIME  
                           \*RST:        SAMPLE

**Manual operation:** See ["External Delay Unit"](#) on page 311

---

**[[:SOURce<hw>]:BB:ARbitrary:TRIGger[:EXtErnal<1|2>]:DElay <Delay>**

The command specifies the trigger delay (expressed as a number of samples) for external triggering.

**Parameters:**

<Delay>                   float  
                           Range:        0 to depends on other values  
                           Increment: 0.01  
                           \*RST:        0  
                           Default unit: sample

**Example:**

```
BB:ARB:TRIG:SOUR EXT
selects an external trigger
BB:ARB:TRIG:DEL 200
sets a delay of 200 samples for the trigger.
```

**Manual operation:** See ["Trigger Delay"](#) on page 312

---

**[[:SOURce<hw>]:BB:ARbitrary:TRIGger[:EXtErnal<1|2>]:TDElay <ExtTimeDelay>**

Specifies the trigger delay (in seconds) for external triggering. The value affects all external trigger signals.

**Parameters:**

<ExtTimeDelay>           float  
                           Range:        0 to 688  
                           Increment: 1E-9  
                           \*RST:        0

**Manual operation:** See ["Trigger Delay"](#) on page 312

---

**[[:SOURce<hw>]:BB:ARbitrary:TRIGger[:EXtErnal<1|2>]:RDElay?**

Queries the time (in seconds) an external trigger event is delayed for.

**Return values:**

<ResTimeDelay> float  
 Range: 0 to 688  
 Increment: 250E-12  
 \*RST: 0

**Usage:** Query only

**Manual operation:** See "[Actual Trigger Delay](#)" on page 312

**[:SOURce<hw>]:BB:ARBitrary:TRIGger[:EXTernal<1|2>]:INHibit <Inhibit>**

Specifies the number of samples by which a restart is to be inhibited following a trigger event. This command applies only in the case of external triggering.

**Parameters:**

<Inhibit> integer  
 Range: 0 to 67108863  
 \*RST: 0  
 Default unit: sample

**Example:**

```
BB:ARB:TRIG:SOUR EXT
selects an external trigger
BB:ARB:TRIG:INH 200
sets a restart inhibit for 200 samples following a trigger event.
```

**Manual operation:** See "[Trigger Inhibit](#)" on page 312

**[:SOURce<hw>]:BB:ARBitrary[:TRIGger]:SEQuence <Sequence>**

The command selects the trigger mode.

**Parameters:**

&lt;Sequence&gt;

AUTO | RETRigger | AAUTo | ARETrigger | SINGle

**AUTO**

The waveform is output continuously.

**RETRigger**

The waveform is output continuously. A trigger event (internal or external) causes a restart.

**AAUTo**

The waveform is output only when a trigger event occurs. After the trigger event the waveform is output continuously. Waveform output is stopped with command

SOUR:BB:ARB:TRIG:ARM:EXEC and started again when a trigger event occurs.

**ARETrigger**

The waveform is output only when a trigger event occurs. The device automatically toggles to RETRIG mode. Every subsequent trigger event causes a restart. Waveform output is stopped with command SOUR:BB:ARB:TRIG:ARM:EXEC and started again when a trigger event occurs.

**SINGle**

The waveform is output only when a trigger event occurs. After the trigger event the waveform is output once to the set sequence length (SOUR:BB:ARB:TRIG:SLen). Every subsequent trigger event causes a restart.

\*RST: RETRigger

**Example:**

BB:ARB:SEQ AAUT

sets the "Armed\_auto" trigger mode; the device waits for the first trigger (e.g. with \*TRG) and then generates the signal continuously.

**Manual operation:** See "Trigger Mode" on page 309**Marker Settings**

[SOURce<hw>]:BB:ARBitrary:TRIGger:OUTPut<ch>:MODE.....	518
[SOURce<hw>]:BB:ARBitrary:TRIGger:OUTPut<ch>:OFFTime.....	519
[SOURce<hw>]:BB:ARBitrary:TRIGger:OUTPut<ch>:ONTime.....	519
[SOURce<hw>]:BB:ARBitrary:TRIGger:OUTPut<ch>:PATtern.....	520
[SOURce<hw>]:BB:ARBitrary:TRIGger:OUTPut<ch>:PULSe:DIVider.....	520
[SOURce<hw>]:BB:ARBitrary:TRIGger:OUTPut<ch>:PULSe:FREQUency?.....	520

---

**[SOURce<hw>]:BB:ARBitrary:TRIGger:OUTPut<ch>:MODE <Mode>**

The command defines the signal for the selected marker output.

**Parameters:**

&lt;Mode&gt;

UNCHanged | REStart | PULSe | PATTern | RATio

**UNCHanged**

A marker signal as defined in the waveform file (tag 'marker mode x') is generated.

**REStart**

A marker signal is generated at every waveform start.

**PULSe**

A pulsed marker signal is generated. The pulse frequency (= sample rate/divider) is defined with the

SOUR:BB:ARB:TRIG:OUTP:PULS:DIV command and can be queried with the SOUR:BB:ARB:TRIG:OUTP:PULS:FREQ? command.

**PATTern**

A marker signal is generated with the aid of a user-definable bit pattern. The bit pattern is entered with the aid of command :BB:ARB:TRIGger:OUTPut:PATTern. The bit pattern is a maximum of 32 bits long.

**RATio**

A regular marker signal corresponding to the Time Off / Time On specifications in the commands :ARB:TRIGger:OUTPut:OFFTime and :ARB:TRIGger:OUTPut:ONTime is generated.

\*RST: UNCHanged

**Example:**

```
BB:ARB:TRIG:OUTP2:MODE PULS
```

selects the pulsed marker signal on output MARKER 2.

```
BB:ARB:TRIG:OUTP2:STAT ON
```

activates the pulsed marker signal on output MARKER 2.

**Manual operation:** See "[Marker Mode](#)" on page 318

```
[[:SOURce<hw>]:BB:ARbitrary:TRIGger:OUTPut<ch>:OFFTime <OffTime>
```

```
[[:SOURce<hw>]:BB:ARbitrary:TRIGger:OUTPut<ch>:ONTime <OnTime>
```

The command sets the number of samples in a period (ON time + OFF time) during which the marker signal in setting :ARB:TRIGger:OUTPut:MODE RATio on the marker outputs is ON.

**Parameters:**

&lt;OnTime&gt;

integer

Range: 1 to 14913079

\*RST: 1

**Example:**

```
BB:ARB:TRIG:OUTP2:ONT 20
```

sets an ON time of 20 samples for marker 2

In case of two-path instruments, on path A.

**Manual operation:** See "[Marker Mode](#)" on page 318

**[:SOURce<hw>]:BB:ARbitrary:TRIGger:OUTPut<ch>:PATTern <Pattern>**

The command defines the bit pattern used to generate the marker signal in the setting `SOURce:BB:ARB:TRIGger:OUTPut:MODE PATTern`. 0 is marker off, 1 is marker on.

**Parameters:**

<Pattern> <32 bits pattern>  
\*RST: 0

**Example:**

`BB:ARB:TRIG:OUTP2:PATT #H39FE0000,32`

sets a bit pattern.

`BB:ARB:TRIG:OUTP2:MODE PATT`

activates the marker signal according to a bit pattern on output MARKER 2.

**Manual operation:** See "[Marker Mode](#)" on page 318

**[:SOURce<hw>]:BB:ARbitrary:TRIGger:OUTPut<ch>:PULSe:DIVider <Divider>**

The command sets the divider for the pulsed marker signal in the setting `SOURce:BB:ARB:TRIGger:OUTPut:MODE PULSe`. The pulse frequency is derived by dividing the symbol rate by the divider.

**Parameters:**

<Divider> integer  
Range: 2 to 1024  
\*RST: 2

**Example:**

`BB:ARB:TRIG:OUTP2:PULS:DIV 2`

sets the divider for the marker signal on output MARKER 2 to the value 2.

`BB:ARB:TRIG:OUTP2:FREQ?`

queries the resulting pulse frequency of the marker signal

Response: 66 000

the resulting pulse frequency is 66 kHz.

**Manual operation:** See "[Marker Mode](#)" on page 318

**[:SOURce<hw>]:BB:ARbitrary:TRIGger:OUTPut<ch>:PULSe:FREQUency?**

The command queries the pulse frequency of the pulsed marker signal in the setting `SOURce:BB:ARB:TRIGger:OUTPut:MODE PULSe`. The pulse frequency is derived by dividing the symbol rate by the divider. The divider is defined with command `:BB:ARB:TRIG:OUTP:PULS:DIV`.

**Return values:**

<Frequency> float  
Increment: 0.001



**Example:** `BB:ARB:TRIG:OUTP2:PULS:DIV 4`  
sets the divider for the marker signal on the output to the value 4.

`BB:ARB:TRIG:OUTP2:MODE PULS`  
enables the pulsed marker signal.

`BB:ARB:TRIG:OUTP2:PULS:FREQ?`  
queries the pulse frequency of the marker signal.

Response: `33 000`  
the resulting pulse frequency is 33 kHz.

**Usage:** Query only

**Manual operation:** See "[Marker Mode](#)" on page 318

### Test Signals Settings

<code>[:SOURce&lt;hw&gt;]:BB:ARbitrary:TSIGnal:CIQ:CREate</code> .....	521
<code>[:SOURce&lt;hw&gt;]:BB:ARbitrary:TSIGnal:RECTangle:CREate</code> .....	521
<code>[:SOURce&lt;hw&gt;]:BB:ARbitrary:TSIGnal:SINE:CREate</code> .....	521
<code>[:SOURce&lt;hw&gt;]:BB:ARbitrary:TSIGnal:CIQ:CREate:NAMed</code> .....	521
<code>[:SOURce&lt;hw&gt;]:BB:ARbitrary:TSIGnal:RECTangle:CREate:NAMed</code> .....	521
<code>[:SOURce&lt;hw&gt;]:BB:ARbitrary:TSIGnal:SINE:CREate:NAMed</code> .....	521
<code>[:SOURce&lt;hw&gt;]:BB:ARbitrary:TSIGnal:CIQ:I</code> .....	522
<code>[:SOURce&lt;hw&gt;]:BB:ARbitrary:TSIGnal:CIQ:Q</code> .....	522
<code>[:SOURce&lt;hw&gt;]:BB:ARbitrary:TSIGnal:RECTangle:AMPLitude</code> .....	522
<code>[:SOURce&lt;hw&gt;]:BB:ARbitrary:TSIGnal:RECTangle:FREQuency</code> .....	522
<code>[:SOURce&lt;hw&gt;]:BB:ARbitrary:TSIGnal:RECTangle:OFFSet</code> .....	523
<code>[:SOURce&lt;hw&gt;]:BB:ARbitrary:TSIGnal:RECTangle:SAMPles</code> .....	523
<code>[:SOURce&lt;hw&gt;]:BB:ARbitrary:TSIGnal:SINE:FREQuency</code> .....	523
<code>[:SOURce&lt;hw&gt;]:BB:ARbitrary:TSIGnal:SINE:PHASe</code> .....	524
<code>[:SOURce&lt;hw&gt;]:BB:ARbitrary:TSIGnal:SINE:SAMPles</code> .....	524

---

**`[:SOURce<hw>]:BB:ARbitrary:TSIGnal:CIQ:CREate`**  
**`[:SOURce<hw>]:BB:ARbitrary:TSIGnal:RECTangle:CREate`**  
**`[:SOURce<hw>]:BB:ARbitrary:TSIGnal:SINE:CREate`**

Generates a signal and uses it as output straight away.

**Example:** `BB:ARB:TSIG:SINE:CRE`  
generates a test sine signal and uses it as output straight away.

**Usage:** Event

**Manual operation:** See "[Generate Signal RAM \(Sine Test Signal\)](#)" on page 322

---

**`[:SOURce<hw>]:BB:ARbitrary:TSIGnal:CIQ:CREate:NAMed <Filename>`**  
**`[:SOURce<hw>]:BB:ARbitrary:TSIGnal:RECTangle:CREate:NAMed <Filename>`**  
**`[:SOURce<hw>]:BB:ARbitrary:TSIGnal:SINE:CREate:NAMed <Filename>`**

Generates a signal and saves it to a waveform file.

**Setting parameters:**

<Filename> string

**Example:** `BB:ARB:TSIG:SINE:CRE:NAM 'sine_test'`  
generates a test sine signal and saves it into the waveform `sine_test`.

**Usage:** Setting only

**Manual operation:** See "[Generate Signal HD \(Sine Test Signal\)](#)" on page 322

`[:SOURce<hw>]:BB:ARbitrary:TSIGnal:CIQ:I <I>`  
`[:SOURce<hw>]:BB:ARbitrary:TSIGnal:CIQ:Q <TSig>`

Sets the value for the Q component of the test signal

**Parameters:**

<TSig> float  
Range: -1 to 1  
Increment: 0.001  
\*RST: 0  
Default unit: FS

**Example:** `BB:ARB:TSIG:CIQ:Q 0.5`  
sets the value for the Q component of the test signal.

**Manual operation:** See "[Q Value \(Const IQ Test Signal\)](#)" on page 323

`[:SOURce<hw>]:BB:ARbitrary:TSIGnal:RECTangle:AMPLitude <Amplitude>`

Sets the digital amplitude of the rectangular wave.

**Parameters:**

<Amplitude> float  
Range: 0 to 1  
Increment: 0.001  
\*RST: 0.800  
Default unit: FS

**Example:** `BB:ARB:TSIG:RECT:AMPL 0.5`  
sets the amplitude of the test signal

**Manual operation:** See "[Amplitude \(Rect Test Signal\)](#)" on page 322

`[:SOURce<hw>]:BB:ARbitrary:TSIGnal:RECTangle:FREQuency <Frequency>`

Sets the frequency of the test signal.

**Parameters:**

<Frequency> float  
Range: 100 to depends on hardware  
Increment: 0.01  
\*RST: 1000

**Example:** `SOURce:BB:ARbitrary:TSIGnal:RECTangle:FREQuency`  
`100 kHz`  
 sets the frequency of the test signal of 100 kHz.

**Manual operation:** See ["Frequency \(Rect Test Signal\)"](#) on page 322

**[:SOURce<hw>]:BB:ARbitrary:TSIGnal:RECTangle:OFFSet <Offset>**

Sets the DC component.

**Parameters:**

<Offset> float  
 Range: -1 to 1  
 Increment: 0.001  
 \*RST: 0  
 Default unit: FS

**Example:** `BB:ARB:TSIG:RECT:OFFS 0.5`  
 sets the DC component

**Manual operation:** See ["Offset DC \(Rect Test Signal\)"](#) on page 323

**[:SOURce<hw>]:BB:ARbitrary:TSIGnal:RECTangle:SAMPles <Samples>**

Sets the number of sample values required for the rectangular signal per period.

**Parameters:**

<Samples> integer  
 Range: 4 to 1000  
 \*RST: 100

**Example:** `BB:ARB:TSIG:RECT:SAMP 400`  
 sets 400 samples per period

**Manual operation:** See ["Samples per Period \(Rect Test Signal\)"](#) on page 322

**[:SOURce<hw>]:BB:ARbitrary:TSIGnal:SINE:FREQuency <Frequency>**

Sets the frequency of the simple sinusoidal test signal. This signal is used as output via the I channel. A sine wave of the same frequency but optionally phase-shifted is generated on the Q path (`ARB:TSIGnal:SINE:POFFset`).

**Parameters:**

<Frequency> float  
 Range: 100 to depends on hardware  
 Increment: 0.01  
 \*RST: 1000  
 Default unit: Hz

**Example:** `BB:ARB:TSIG:SINE:FREQ 100 kHz`  
 sets a sine signal of 100 kHz.

**Manual operation:** See ["Frequency \(Sine Test Signal\)"](#) on page 321

**[:SOURce<hw>]:BB:ARbitrary:TSIGnal:SINE:PHASe <Phase>**

The command sets the phase offset of the sine wave on the Q channel relative to the sine wave on the I channel.

**Parameters:**

<Phase> float  
 Range: -180 to 180  
 Increment: 0.01  
 \*RST: 90  
 Default unit: DEG

**Example:** BB:ARB:TSIG:SINE:PHAS 90  
 sets a phase offset of 90 degrees.

**Manual operation:** See "[Phase Offset Q \(Sine Test Signal\)](#)" on page 321

**[:SOURce<hw>]:BB:ARbitrary:TSIGnal:SINE:SAMPles <Samples>**

The command sets the sample rate for the sine signal in samples per period.

The resulting clock rate must not exceed the maximum ARB clock rate of 100 MHz.

The maximum value is automatically restricted by reference to the set frequency and has to fulfill the rule  $\text{Frequency} * \text{Samples} \leq \text{ARB clock rate}$ .

**Parameters:**

<Samples> integer  
 Range: 4 to 1000  
 \*RST: 100  
 Default unit: 100 samples per period

**Example:** BB:ARB:TSIG:SINE:SAMP 100  
 sets a sample rate of 100 samples per period.

**Manual operation:** See "[Samples per Period \(Sine Test Signal\)](#)" on page 321

**SOURce:BB:ARB:MCAR Subsystem**

The `MCARrier` subsystem contains the commands for setting the Multi Carrier Waveform Generator.

Section [Chapter 7.4, "Waveform and List Format"](#), on page 432 describes the ARB waveform format and how it is used to transmit waveforms via the IEC bus.

**CARRier<ch>**

The numerical suffix under `CARRier` distinguish between the carriers. The value range is 0 .. 31.

<a href="#">[:SOURce&lt;hw&gt;]:BB:ARbitrary:MCARrier:CARRier:COUNT.....</a>	525
<a href="#">[:SOURce&lt;hw&gt;]:BB:ARbitrary:MCARrier:CARRier:MODE.....</a>	526
<a href="#">[:SOURce&lt;hw&gt;]:BB:ARbitrary:MCARrier:CARRier:SPACing.....</a>	526
<a href="#">[:SOURce&lt;hw&gt;]:BB:ARbitrary:MCARrier:CARRier&lt;ch&gt;:CONFlict?.....</a>	527

[SOURce<hw>]:BB:ARBitrary:MCARrier:CARRier<ch>:DELay.....	527
[SOURce<hw>]:BB:ARBitrary:MCARrier:CARRier<ch>:FILE.....	527
[SOURce<hw>]:BB:ARBitrary:MCARrier:CARRier<ch>:FREQuency.....	527
[SOURce<hw>]:BB:ARBitrary:MCARrier:CARRier<ch>:PHASe.....	528
[SOURce<hw>]:BB:ARBitrary:MCARrier:CARRier<ch>:POWer.....	528
[SOURce<hw>]:BB:ARBitrary:MCARrier:POWer:REFerence.....	528
[SOURce<hw>]:BB:ARBitrary:MCARrier:CARRier<ch>:STATe.....	529
[SOURce<hw>]:BB:ARBitrary:MCARrier:CFACTOR:MODE.....	529
[SOURce<hw>]:BB:ARBitrary:MCARrier:CLIPping:CFACTOR.....	529
[SOURce<hw>]:BB:ARBitrary:MCARrier:CLIPping:CUToff.....	530
[SOURce<hw>]:BB:ARBitrary:MCARrier:CLIPping[STATe].....	530
[SOURce<hw>]:BB:ARBitrary:MCARrier:CLOad.....	531
[SOURce<hw>]:BB:ARBitrary:MCARrier:CLOCK?.....	531
[SOURce<hw>]:BB:ARBitrary:MCARrier:CREate.....	532
[SOURce<hw>]:BB:ARBitrary:MCARrier:EDIT:CARRier:DELay:STEP.....	532
[SOURce<hw>]:BB:ARBitrary:MCARrier:EDIT:CARRier:DELay[START].....	533
[SOURce<hw>]:BB:ARBitrary:MCARrier:EDIT:CARRier:EXECute.....	533
[SOURce<hw>]:BB:ARBitrary:MCARrier:EDIT:CARRier:FILE.....	533
[SOURce<hw>]:BB:ARBitrary:MCARrier:EDIT:CARRier:PHASe:STEP.....	534
[SOURce<hw>]:BB:ARBitrary:MCARrier:EDIT:CARRier:PHASe[START].....	534
[SOURce<hw>]:BB:ARBitrary:MCARrier:EDIT:CARRier:POWer:STEP.....	534
[SOURce<hw>]:BB:ARBitrary:MCARrier:EDIT:CARRier:POWer[START].....	535
[SOURce<hw>]:BB:ARBitrary:MCARrier:EDIT:CARRier:START.....	535
[SOURce<hw>]:BB:ARBitrary:MCARrier:EDIT:CARRier:STOP.....	535
[SOURce<hw>]:BB:ARBitrary:MCARrier:EDIT:CARRier:STATe.....	536
[SOURce<hw>]:BB:ARBitrary:MCARrier:OFILe.....	536
[SOURce<hw>]:BB:ARBitrary:MCARrier:PRESet.....	536
[SOURce<hw>]:BB:ARBitrary:MCARrier:SAMPles?.....	536
[SOURce<hw>]:BB:ARBitrary:MCARrier:SETTing:CATalog?.....	537
[SOURce<hw>]:BB:ARBitrary:MCARrier:SETTing:LOAD.....	537
[SOURce<hw>]:BB:ARBitrary:MCARrier:SETTing:STORE.....	537
[SOURce<hw>]:BB:ARBitrary:MCARrier:SETTing:STORE:FAST.....	538
[SOURce<hw>]:BB:ARBitrary:MCARrier:TIME.....	538
[SOURce<hw>]:BB:ARBitrary:MCARrier:TIME:MODE.....	538

---

**[SOURce<hw>]:BB:ARBitrary:MCARrier:CARRier:COUNT <Count>**

Sets the number of carriers in the ARB multi carrier waveform.

**Parameters:**

<Count>	integer
	Range: 1 to 512
	*RST: 1

**Example:** BB:ARB:MCAR:CARR:COUN 10  
sets 10 carriers for the multi carrier waveform.

**Manual operation:** See "Number of Carriers" on page 344

---

**[ :SOURce<hw>]:BB:ARbitrary:MCARrier:CARRier:MODE <Mode>**

The command sets the carrier frequency mode.

**Parameters:**

<Mode> EQUidistant | ARbitrary

**EQUidistant**

Sets an equidistant carrier spacing. The carrier frequency in the carrier table is not configurable.

**ARbitrary**

Enables you to specify the carrier frequency in the carrier table. Carrier spacing is irrelevant.

\*RST: EQUidistant

**Example:**

BB:ARB:MCAR:CARR:MODE EQU

sets an equidistant carrier spacing. The carrier frequency can not be set.

**Manual operation:** See "[Mode](#)" on page 343

---

**[ :SOURce<hw>]:BB:ARbitrary:MCARrier:CARRier:SPACing <Spacing>**

The command sets the frequency spacing between adjacent carriers of the multi carrier waveform. The carriers are generated symmetrically around the RF carrier. The maximum carrier spacing is limited to **Carrier spacing = Total baseband bandwidth / (Number of carriers - 1)**.

The total baseband bandwidth is 80 MHz.

**Note:** In order to avoid wrap-around problems, the effective "Carrier Spacing" might be slightly modified. The "Carrier Spacing" is rounded in that way that the carrier closest to the center RF frequency shows no phase jump assuming that the carrier is unmodulated.

- For odd number of carriers:  
RoundedCarrierSpacing=1/OutputSignalDuration\* round(CarrierSpacing \* OutputSignalDuration);
- For even number of carriers:  
RoundedCarrierSpacing=2/OutputSignalDuration\*round(0.5 \*CarrierSpacing \* OutputSignalDuration);

**Parameters:**

<Spacing> float  
Range: 0.0 to 120E6  
Increment: 0.01  
\*RST: 0  
Default unit: Hz

**Example:**

BB:ARB:MCAR:CARR:SPAC 10 MHz

sets a carrier spacing of 10 MHz.

**Manual operation:** See "[Carrier Spacing](#)" on page 344

**[[:SOURce<hw>]:BB:ARbitrary:MCARrier:CARRier<ch>:CONFLICT?**

Queries carrier conflicts. A conflict arises when the carriers overlap.

**Return values:**

<Conflict>            0 | 1 | OFF | ON  
 \*RST:                0

**Example:**

BB:ARB:MCAR:CARR2:CONF?  
 queries the multi carrier conflict state.  
 Response: 0 no conflict has occurred.

**Usage:**                Query only

**Manual operation:**   See "!!!" on page 353

**[[:SOURce<hw>]:BB:ARbitrary:MCARrier:CARRier<ch>:DELay <Delay>**

Sets the start delay of the selected carrier.

**Parameters:**

<Delay>                float  
                           Range:        0 to 1  
                           Increment: 1E-9  
                           \*RST:        0  
                           Default unit: s

**Example:**

BB:ARB:MCAR:CARR15:DEL 5us  
 sets a start delay of 50 us for carrier 15.

**Manual operation:**   See "Delay" on page 352

**[[:SOURce<hw>]:BB:ARbitrary:MCARrier:CARRier<ch>:FILE <File>**

Selects the file with I/Q data to be modulated onto the selected carrier.

**Parameters:**

<File>                 <file name>

**Example:**

BB:ARB:MCAR:CARR15:FILE "D:\user\IQ\_wcdma"  
 selects file IQ\_wcdma. The data of the file is modulated onto  
 carrier 15.

**Manual operation:**   See "File" on page 353

**[[:SOURce<hw>]:BB:ARbitrary:MCARrier:CARRier<ch>:FREQuency <Frequency>**

Sets or indicates the carrier frequency, depending on the selected carrier frequency mode.

The carrier frequency can be set in "Arbitrary Carrier frequency" mode. For "Equidistant Carrier Spacing", the carrier spacing is determined automatically.

**Parameters:**

<Frequency> integer  
 Vvalue range depends on the max bandwidth, see data sheet  
 Range: -40E6 to 40E6  
 \*RST: 0

**Example:**

BB:ARB:MCAR:CARR:MODE ARB  
 activates ARB multi carrier mode.  
 BB:ARB:MCAR:CARR:FREQ 5.0  
 sets 5.0 MHz carrier frequency.

**Manual operation:** See "[Carrier Freq \[MHz\]](#)" on page 352

**[:SOURce<hw>]:BB:ARbitrary:MCARrier:CARRier<ch>:PHASe <Phase>**

The command sets the start phase of the selected carrier.

The phase settings are only valid if optimization of the crest factor is disabled  
 (:SOURce:BB:ARB:MCARrier:CFACTOR:MODE OFF).

**Parameters:**

<Phase> float  
 Range: 0 to 359.99  
 Increment: 0.01  
 \*RST: 0  
 Default unit: DEG

**Example:**

BB:ARB:MCAR:CARR15:PHAS 90 DEG  
 sets a start phase of 90° for carrier 15.

**Manual operation:** See "[Phase](#)" on page 352

**[:SOURce<hw>]:BB:ARbitrary:MCARrier:CARRier<ch>:POWER <Power>**

The command sets the gain of the selected carrier.

**Parameters:**

<Power> float  
 Range: -80 to 0  
 Increment: 0.01  
 \*RST: 0  
 Default unit: dB

**Example:**

BB:ARB:MCAR:CARR15:POW -50 dB  
 sets the power of carrier 15 to -50 dB.

**Manual operation:** See "[Gain](#)" on page 352

**[:SOURce<hw>]:BB:ARbitrary:MCARrier:POWER:REFERence <Reference>**

Defines the way the individual carriers in a composed multi carrier signal are leveled.



**Parameters:**

<Reference> RMS | PEAK  
 \*RST: RMS

**Manual operation:** See "[Power Reference](#)" on page 346

**[:SOURce<hw>]:BB:ARbitrary:MCARrier:CARRier<ch>:STATe <State>**

Enables/disables the selected carrier.

**Parameters:**

<State> 0 | 1 | OFF | ON  
 \*RST: 0

**Example:** SOURce1:BB:ARbitrary:MCARrier:CARRier15:STATe  
 ON

**Manual operation:** See "[State](#)" on page 352

**[:SOURce<hw>]:BB:ARbitrary:MCARrier:CFACTOR:MODE <Mode>**

The command sets the mode for optimizing the crest factor by calculating the carrier phases.

**Parameters:**

<Mode> OFF | MIN | MAX

**OFF**

There is no automatic setting for minimizing or maximizing the crest factor. The Phase setting (command BB:ARB:MCAR:CARR:PHAS) is in use.

**MIN**

The crest factor is minimized by internally calculating optimized carrier phases. The Phase setting (command BB:ARB:MCAR:CARR:PHAS) is invalid.

**MAX**

The crest factor is maximized by internally calculating optimized carrier phases. The Phase setting (command BB:ARB:MCAR:CARR:PHAS) is invalid.

\*RST: OFF

**Example:** BB:ARB:MCAR:CFACTOR:MODE OFF  
 switches off automatic crest factor optimization. The setting SOUR:BB:ARB:MCAR:CARR:PHAS has an effect.

**Manual operation:** See "[Crest Factor Mode](#)" on page 344

**[:SOURce<hw>]:BB:ARbitrary:MCARrier:CLIPping:CFACTOR <CFactor>**

Sets the value of the desired crest factor, if baseband clipping is enabled (BB:ARB:MCAR:CLIP:STAT ON).

A Target Crest Factor above the crest factor of the unclipped multicarrier signal has no effect.

**Parameters:**

<CFactor> float  
 Range: -50 to 50  
 Increment: 0.01  
 \*RST: 50  
 Default unit: dB

**Example:**

BB:ARB:MCAR:CLIP:STAT ON  
 enables clipping.  
 BB:ARB:MCAR:CLIP:CFAC 37 dB  
 sets the target crest factor.

**Manual operation:** See "[Target Crest Factor](#)" on page 345

**[[:SOURce<hw>]:BB:ARbitrary:MCARrier:CLIPping:CUToff <Cutoff>**

Sets the cut off frequency of the final lowpass filter, if baseband clipping is enabled (BB:ARB:MCAR:CLIP:STAT ON).

When the cut off frequency is set as half of the output sample rate, a final lowpass filter improves the spectrum of the clipped multicarrier signal, but may also increase the resulting crest factor.

**Parameters:**

<Cutoff> float  
 Range: 0 to 50E6  
 Increment: 0.01  
 \*RST: 50E6  
 Default unit: MHz

**Example:**

BB:ARB:MCAR:CLIP:STAT ON  
 enables clipping  
 BB:ARB:MCAR:CLIP:CUT 50 MHz  
 sets the cut off frequency of the filter.

**Manual operation:** See "[Filter Cut Off Frequency](#)" on page 345

**[[:SOURce<hw>]:BB:ARbitrary:MCARrier:CLIPping[:STATe] <State>**

Switches baseband clipping on and off.

Clipping reduces the peak power of the resulting multi carrier signal according to the value set with the command BB:ARB:MCAR:CLIP:CFAC.

The resulting clipped peak power is defined by sum of the the RMS level of the unclipped multi carrier signal and the input parameter Target Crest Factor. Note that clipping reduces also the RMS level. Hence the resulting crest factor of the clipped signal is slightly above the Target Crest Factor. In order to get the unclipped parts of the clipped multicarrier signal matched with the unclipped multicarrier signal, the RF output power should be reduced by the difference between resulting crest factor and Target Crest Factor.

**Parameters:**

<State> 0 | 1 | OFF | ON  
 \*RST: 0

**Example:**

```
BB:ARB:MCAR:CLIP:STAT ON
enables clipping
BB:ARB:MCAR:CLIP:CFAC 37 dB
sets the target crest factor.
```

**Manual operation:** See ["Clipping"](#) on page 345

**[[:SOURce<hw>]:BB:ARbitrary:MCARrier:CLOad**

Creates a multi carrier waveform using the current entries of the carrier table.

This multi carrier waveform is saved with the file name specified with command `SOUR:BB:ARB:MCAR:OFIL`. The file extension is `*.wv`. Digital standard "ARB" is activated, the new multi carrier waveform is loaded and is output in accordance to the trigger settings.

**Example:**

```
MMEM:CDIR 'D:\user\waveform'
sets the default directory.
BB:ARB:MCAR:OFIL 'mcar1_2'
defines the file name mcar1_2.wv for the multi carrier waveform.
BB:ARB:MCAR:CLO
creates multi carrier waveform mcar1_2.wv.
The new multi carrier waveform is loaded and digital standard "ARB" is activated.
```

**Usage:** Event

**Manual operation:** See ["Create and Load"](#) on page 349

**[[:SOURce<hw>]:BB:ARbitrary:MCARrier:CLOCK?**

The command queries the resulting sample rate at which the multi carrier waveform is output by the arbitrary waveform generator. The output clock rate depends on the number of carriers, carrier spacing and input sample rate of the leftmost or rightmost carriers.

**Return values:**

<Clock> float  
 Range: 400 to Max  
 Increment: 1E-3

**Example:** BB:ARB:MCAR:CLOC?  
 queries the ARB multi carrier output clock rate.

**Usage:** Query only

**Manual operation:** See "[Clock Rate](#)" on page 348

**[:SOURce<hw>]:BB:ARbitrary:MCARrier:CREate**

Creates a multi carrier waveform using the current settings of the carrier table. The multi carrier waveform is saved into the file defined with command SOUR:BB:ARB:MCAR:OFIL. The file extension is \*.wv.

**Example:** MMEM:CDIR 'D:\user\waveform'  
 sets the default directory.  
 BB:ARB:MCAR:OFIL 'multi\_wv1'  
 defines the file name multi\_wv1.wv for the multi carrier waveform.  
 BB:ARB:MCAR:CRE  
 creates multi carrier waveform multi\_wv1.wv.

**Usage:** Event

**Manual operation:** See "[Create](#)" on page 349

**[:SOURce<hw>]:BB:ARbitrary:MCARrier:EDIT:CARRier:DELay:STEP <Step>**

The command sets the step width by which the start delays of the carriers in the defined carrier range will be incremented.

**Parameters:**

<Step> float  
 Range: -1 to 1  
 Increment: 1E-9  
 \*RST: 0  
 Default unit: s

**Example:** BB:ARB:MCAR:EDIT:CARR:DEL 5 us  
 sets a start delay of 5 us for the carriers in the carrier range.  
 BB:ARB:MCAR:EDIT:CARR:DEL:STEP 1 us  
 the start delay is incremented by 1us for each carrier, i.e. the first carrier has a start delay of 5us, the second a start delay of 6 us, etc.

**Manual operation:** See "[Delay Step](#)" on page 351

**[[:SOURce<hw>]:BB:ARbitrary:MCARrier:EDIT:CARRier:DELay[:STARt] <Start>**

The command sets the start delay for the individual carriers in the defined carrier range. If the command `:BB:ARB:MCAR:EDIT:CARR:DEL:STEP` is used to define a step width, the delay entered here applies only to the starting carrier. The delays of the remaining carriers are stepped up or down by the delay value specified in the `:BB:ARB:MCAR:EDIT:CARR:DEL:STEP` command.

**Parameters:**

<Start> float  
 Range: 0 to 1  
 Increment: 1E-9  
 \*RST: 0  
 Default unit: s

**Example:** `BB:ARB:MCAR:EDIT:CARR:DEL 5us`  
 sets a start delay of 5 us for the carriers in the carrier range.

**Manual operation:** See ["Delay Start"](#) on page 351

**[[:SOURce<hw>]:BB:ARbitrary:MCARrier:EDIT:CARRier:EXECute**

The command adopts the settings for the carrier range which has been defined using the `:BB:ARB:MCAR:EDIT:CARR:...` commands.

**Example:** `BB:ARB:MCAR:EDIT:CARR:STAR 4`  
 the carrier range starts at carrier 2.  
`BB:ARB:MCAR:EDIT:CARR:STOP 20`  
 the carrier range stops at carrier 20.  
`BB:ARB:MCAR:EDIT:CARR:STAT ON`  
 sets all the carriers in the carrier range (2 to 20) to ON.  
`BB:ARB:MCAR:EDIT:CARR:EXEC`  
 transfers the assistant settings for carrier 2 to 20 into the carrier table.

**Usage:** Event

**Manual operation:** See ["Apply Assistant Settings"](#) on page 351

**[[:SOURce<hw>]:BB:ARbitrary:MCARrier:EDIT:CARRier:FILE <File>**

Selects input file

**Parameters:**

<File> string

**Example:** `BB:ARB:MCAR:EDIT:CARR:FILE "D:\user\IQ_wcdma"`

**Manual operation:** See ["Input Waveform File"](#) on page 351

**[:SOURce<hw>]:BB:ARbitrary:MCARrier:EDIT:CARRier:PHASe:STEP <Step>**

The command sets the step width by which the start phases of the carriers in the defined carrier range will be incremented.

The phase settings are only valid if optimization of the crest factor is disabled (`:SOURce:BB:ARB:MCARrier:CFACTOR:MODE OFF`).

**Parameters:**

<Step> float  
 Range: -359.99 to 359.99  
 Increment: 0.01  
 \*RST: 0  
 Default unit: DEG

**Example:**

`BB:ARB:MCAR:EDIT:CARR:PHAS 90 DEG`  
 sets a start phase of 90° for the carriers in the carrier range.  
`BB:ARB:MCAR:EDIT:CARR:PHAS:STEP 1 DEG`  
 the start phase is incremented by 1° for each carrier, i.e. the first carrier has a start phase of 90°, the second a start phase of 91°, etc.

**[:SOURce<hw>]:BB:ARbitrary:MCARrier:EDIT:CARRier:PHASe[:START] <Start>**

The command sets the start phase for the individual carriers in the defined carrier range. If the command `:BB:ARB:MCAR:EDIT:CARR:PHAS:STEP` is used to define a step width, the phase entered here applies only to the starting carrier. The phases of the remaining carriers are stepped up or down by the phase value specified in the `:BB:ARB:MCAR:EDIT:CARR:PHAS:STEP` command.

The phase settings are only valid if optimization of the crest factor is disabled (`:SOURce:BB:ARB:MCARrier:CFACTOR:MODE OFF`).

**Parameters:**

<Start> float  
 Range: 0 to 359.99  
 Increment: 0.01  
 \*RST: 0  
 Default unit: DEG

**Example:**

`BB:ARB:MCAR:EDIT:CARR:PHAS 90 DEG`  
 sets a start phase of 90° for the carriers in the carrier range.

**Manual operation:** See "[Phase Start](#)" on page 351

**[:SOURce<hw>]:BB:ARbitrary:MCARrier:EDIT:CARRier:POWER:STEP <Step>**

The command sets the step width by which the starting power of the carriers in the defined carrier range will be incremented.

**Parameters:**

<Step> float  
 Range: -80 to 80  
 Increment: 0.01  
 \*RST: 0  
 Default unit: dB

**Example:**

BB:ARB:MCAR:EDIT:CARR:POW -80dB  
 sets a power of -80 dB for the carriers in the carrier range.  
 BB:ARB:MCAR:EDIT:CARR:POW:STEP 1 dB  
 the power is incremented by 1dB for each carrier, i.e. the first carrier has -80dB, the second -79dB, etc.

**Manual operation:** See ["Gain Step"](#) on page 350

**[[:SOURce<hw>]:BB:ARbitrary:MCARrier:EDIT:CARRier:POWER[:START] <Start>**

The command sets the power for the individual carriers in the defined carrier range. If the command `:BB:ARB:MCAR:EDIT:CARR:POW:STEP` is used to define a step width, the power entered here applies only to the starting carrier. The power of the remaining carriers is stepped up or down by the power specified in the `:BB:ARB:MCAR:EDIT:CARR:POW:STEP` command.

**Parameters:**

<Start> float  
 Range: -80 to 0  
 Increment: 0.01  
 \*RST: 0  
 Default unit: dB

**Example:**

BB:ARB:MCAR:EDIT:CARR:POW -50 dB  
 sets the power of the carriers in the carrier range to -50 dB.

**Manual operation:** See ["Gain Start"](#) on page 350

**[[:SOURce<hw>]:BB:ARbitrary:MCARrier:EDIT:CARRier:START <Start>**

**[[:SOURce<hw>]:BB:ARbitrary:MCARrier:EDIT:CARRier:STOP <Stop>**

The command selects the last carrier in the carrier range to which the settings with the `:BB:ARB:MCAR:EDIT:CARR:..` commands shall apply.

**Parameters:**

<Stop> integer  
 Range: 0 to 511  
 \*RST: 0

**Example:**

BB:ARB:MCAR:EDIT:CARR:STOP 4  
 the carrier range stops at carrier 4.

**Manual operation:** See ["Carrier Stop"](#) on page 350

---

**[:SOURce<hw>]:BB:ARbitrary:MCARrier:EDIT:CARRier:STATe <State>**

The command switches all the carriers in the selected carrier range on or off.

**Parameters:**

<State>                    0 | 1 | OFF | ON  
 \*RST:                    1

**Example:**                BB:ARB:MCAR:EDIT:CARR:STAT ON  
 sets all the carriers in the carrier range to ON.

**Manual operation:**    See "[Carrier State](#)" on page 350

---

**[:SOURce<hw>]:BB:ARbitrary:MCARrier:OFILe <OFile>**

This command defines the output file name for the multi carrier waveform. This file name is used when a waveform is calculated (command SOUR:BB:ARB:MCAR:CLOad or SOUR:BB:ARB:MCAR:CREate). The file extension is \*.wv.

**Parameters:**

<OFile>                    string

**Example:**                MMEM:CDIR "D:\user\waveform"  
 sets the default directory.  
 BB:ARB:MCAR:OFIL 'mcar1\_2'  
 defines the file name mcar1\_2.wv for the multi carrier waveform file

**Manual operation:**    See "[File](#)" on page 348

---

**[:SOURce<hw>]:BB:ARbitrary:MCARrier:PRESet**

Sets all ARB multi carrier parameters to their default values.

**Example:**                SOURce1:BB:ARB:MCARrier:PRESet

**Usage:**                    Event

**Manual operation:**    See "[Set to Default](#)" on page 342

---

**[:SOURce<hw>]:BB:ARbitrary:MCARrier:SAMPles?**

The command queries the resulting file size. The file size is returned in samples.

**Return values:**

<Samples>                    integer  
 Range:                    0 to INT\_MAX  
 \*RST:                    0

**Example:**                BB:ARB:MCAR:SAMP?  
 queries the file size of the currently calculated multi carrier waveform.

**Usage:**                    Query only



**Manual operation:** See ["File Size"](#) on page 348

---

**[:SOURce<hw>]:BB:ARbitrary:MCARrier:SETTING:CATalog?**

Queries the available settings files in the specified default directory. The settings files are used to set the ARB multi carrier submenu. Only files with the file extension \*.arb\_multcarr will be listed.

**Return values:**

<Catalog> string

**Example:**

```
MMEM:CDIR 'D:\user\waveform'
sets the default directory
BB:ARB:MCAR:SETT:CAT?
reads out all the settings files in the default directory.
Response: mcar1, mcar2
the directory contains the configuration files
mcar1.arb_multcarr and mcar2.arb_multcarr.
```

**Usage:** Query only

**Manual operation:** See ["Save/Recall Frame"](#) on page 342

---

**[:SOURce<hw>]:BB:ARbitrary:MCARrier:SETTING:LOAD <Filename>**

Loads the settings file. If a settings file with the specified name does not yet exist, it is created. The file extension may be omitted. Only files with the file extension \*.arb\_multcarr will be loaded or created.

**Setting parameters:**

<Filename> string

**Example:**

```
BB:ARB:MCAR:SETT:LOAD 'D:\user\new'
creates settings file new.arb_multcarr.
```

**Usage:** Setting only

**Manual operation:** See ["Save/Recall Frame"](#) on page 342

---

**[:SOURce<hw>]:BB:ARbitrary:MCARrier:SETTING:STORE <Filename>**

The command stores the current settings of submenu "Multi Carrier" in a file in the specified directory. The file extension may be omitted, the files are stored with the file extension \*.arb\_multcarr.

**Setting parameters:**

<Filename> string

**Example:**

```
BB:ARB:MCAR:SETT:STOR 'D:\user\mcarr2'
stores settings file mcarr2.arb_multcarr in the default directory.
```

**Usage:** Setting only

**Manual operation:** See ["Save/Recall Frame"](#) on page 342

---

**[:SOURce<hw>]:BB:ARbitrary:MCARrier:SETTING:STORE:FAST <Fast>**

Determines whether the instrument performs an absolute or a differential storing of the settings.

Enable this function to accelerate the saving process by saving only the settings with values different to the default ones.

**Note:** This function is not affected by the "Preset" function.

**Parameters:**

<Fast>                    0 | 1 | OFF | ON  
                               \*RST:            1

**Manual operation:** See ["Fast Save"](#) on page 169

---

**[:SOURce<hw>]:BB:ARbitrary:MCARrier:TIME <Time>**

Sets the user-defined signal period. This setting is only possible for Signal Period Mode User (BB:ARB:MCAR:TIME:MODE USER).

**Parameters:**

<Time>                    float  
                               Range:            0 to 1E9  
                               Increment:      1E-9  
                               \*RST:            0  
                               Default unit: s

**Example:**

```
BB:ARB:MCAR:TIME:MODE USER
selects Signal Period Mode User.
BB:ARB:MCAR:TIME 10 s
sets a signal period of 10 seconds
```

**Manual operation:** See ["Signal Period"](#) on page 346

---

**[:SOURce<hw>]:BB:ARbitrary:MCARrier:TIME:MODE <Mode>**

Selects the mode for calculating the resulting signal period of the multi carrier waveform. The resulting period is always calculated for all carriers in the carrier table irrespective of their state (ON/OFF).

**Parameters:**

<Mode> LONG | SHORT | LCM | USER

**LONG**

The resulting signal period is defined by the longest I/Q file in the carrier table. Shorter I/Q files are periodically repeated.

**SHORT**

The resulting signal period is defined by the shortest I/Q file in the carrier table. Only the first part of longer I/Q files is used.

**USER**

The signal period can be set with command `[ :SOURce<hw> ] : BB:ARbitrary:MCARrier:TIME`. Shorter I/Q files are repeated periodically, and only the first part of longer I/Q files is used.

**LCM**

The output file duration is the least common multiple of all input file durations.

\*RST: LONG

**Example:**

`SPOURce1:BB:ARbitrary:MCARrier:TIME:MODE LONG`  
selects signal period mode long

**Manual operation:** See "Signal Period Mode" on page 345

**SOURce:BB:ARB:WAV Subsystem**

The WAVeform subsystem contains the commands for working with waveform files.

<code>[ :SOURce&lt;hw&gt; ] : BB:ARbitrary:WAVeform:CATalog?</code>	539
<code>[ :SOURce&lt;hw&gt; ] : BB:ARbitrary:WAVeform:CATalog:LENGth?</code>	540
<code>:MMEMory:DATA:UNPRotected</code>	540
<code>[ :SOURce&lt;hw&gt; ] : BB:ARbitrary:WAVeform:CLOCK</code>	541
<code>[ :SOURce&lt;hw&gt; ] : BB:ARbitrary:WAVeform:DATA</code>	542
<code>[ :SOURce&lt;hw&gt; ] : BB:ARbitrary:WAVeform:DELeTe</code>	543
<code>[ :SOURce&lt;hw&gt; ] : BB:ARbitrary:WAVeform:FREE?</code>	543
<code>[ :SOURce&lt;hw&gt; ] : BB:ARbitrary:WAVeform:HDDStreaming:BLEVel?</code>	543
<code>[ :SOURce&lt;hw&gt; ] : BB:ARbitrary:WAVeform:HDDStreaming:STATe</code>	544
<code>[ :SOURce&lt;hw&gt; ] : BB:ARbitrary:WAVeform:POINts?</code>	544
<code>[ :SOURce&lt;hw&gt; ] : BB:ARbitrary:WAVeform:SELeCt</code>	545
<code>[ :SOURce&lt;hw&gt; ] : BB:ARbitrary:WAVeform:TAG?</code>	545

**[ :SOURce<hw> ] : BB:ARbitrary:WAVeform:CATalog?**

Reads out the files in the default directory. The default directory is set using command `MMEM:CDIRectory`. When the names of the waveform files are returned they are separated by commas. Only files with the file extension `*.wv` will be listed.

**Return values:**

<Catalog> string

**Example:** MMEM:CDIR 'D:\user\waveform'  
sets the default directory.  
BB:ARB:WAV:CAT?  
reads out all the files in the default directory.  
Response: sin1, wave  
the directory contains the waveform files sin1.wv and wave.wv.

**Usage:** Query only

#### **[ :SOURce<hw>]:BB:ARbitrary:WAVEform:CATalog:LENGth?**

Reads out the files in the default directory and returns the number of waveform files in this directory. The default directory is set using command MMEM:CDIRectory. Only files with the file extension \*.wv will be listed.

#### **Return values:**

<Length> integer  
Number of waveform files in default directory  
Range: 0 to INT\_MAX  
\*RST: 0

**Example:** MMEM:CDIR 'D:\user\waveform'  
sets the default directory.  
BB:ARB:WAV:CAT?  
reads out all the files in the default directory.  
Response: sin1, wave  
the directory contains the waveform files sin1.wv and wave.wv.  
BB:ARB:WAV:CAT:LEN?  
Response: 2

**Usage:** Query only

#### **:MMEMory:DATA:UNPRotected <Msus>, <Data>**

The **setting** command sends the I/Q data and the marker data to the file defined with the <Msus> parameter. The required tags are created automatically so that the file content follows the waveform file format.

The **query** reads out the I/Q data part or the marker information of the specified file.

Waveform files can also be created with the command `[ :SOURce<hw>]:BB:ARbitrary:WAVEform:DATA`. In this case, the *complete content* of the waveform file must be specified, i.e. not only the I/Q or marker data but all required tags.

**Parameters:**

<Msus> <Identifier>:<file name>  
 Mass Storage Unit Specifier  
 A string that specifies whether I/Q data (NVWFM) or marker data (NVMKR) is transferred and the file name the data is stored in. If the file with the specified name does not exist, a file is created. Any existing content in the file is *overwritten*. Complete file path and file extension may also be specified. If omitted, files are stored in the default directory and the extension \*.wv is assigned to the file name.

**Setting parameters:**

<Data> block data  
 I/Q data or marker binary data, where the number of marker elements should be equal to the number of I/Q samples  
**I0Q0..IxQx...IN-1QN-1**  
 IxQx... represents binary data (16-bit signed integer in 2's complement notation) containing the I and Q component alternately and starting with the I component. Each component consists of two bytes in MSB format (most significant byte first). The values of the two bytes in an I component and a Q component are in the range: -32768 to +32767.  
**M0M1...Mx...MN-1**  
 Mx represents one marker byte, where only the last 4 bits are used. These 4 bits are assigned to the 4 possible markers of the instrument, one bit per marker: Bit<sub>0</sub> = Marker 1, ... Bit<sub>3</sub> = Marker 4.  
 One 4 bit marker elements is required for every I/Q sample.

**Example:**

```
:MMEM:DATA:UNPR "NVWFM:/var/user/wave.wv",#232123456789009876543218978
// the specified I/Q data is added to a file named wave.wv
// in the specified directory
:MMEMory:DATA:UNPRotected? "NVWFM:/var/user/wave.wv"
:MMEMory:DATA:UNPRotected "NVMKR:/var/user/wave.wv",#185*7uuf5*
// the specified marker data is added to a file named wave.wv
// in the specified directory
// used are printable values;
// used are only the last 4 bits of a byte
:MMEMory:DATA:UNPRotected? "NVMKR:/var/user/wave.wv"
// note that, the query returns binary values
SOURce1:BB:ARbitrary:WAVeform:CLOCK "/var/user/wave.wv",1.1E6
SOURce1:BB:ARbitrary:WAVeform:CLOCK? "/var/user/wave.wv"
```

---

**[:SOURce<hw>]:BB:ARbitrary:WAVeform:CLOCK <Filename>, <Clock>**

Appends information on the ARB clock rate to specified waveform file. The file must contain I/Q and/or marker data and have been created with the command `:MMEMory:DATA:UNPRotected` on page 540.

**Parameters:**

<Filename> string  
 Complete file path and file name with file extension (\* .wv).  
 If the file is in the default directory, the file path can be omitted.

**Setting parameters:**

<Clock> float  
 Range: 400 to 100E6  
 Increment: 1E-3  
 \*RST: 1E6

**Example:** see [:MMEMory:DATA:UNPRotected](#) on page 540

```
[:SOURce<hw>]:BB:ARbitrary:WAVeform:DATA <Filename>, <Data>  

[:SOURce<hw>]:BB:ARbitrary:WAVeform:DATA? <Tag>
```

The **setting** command writes the binary block data <data> to the file identified by <filename>. The complete content of the waveform file is transmitted as a binary data block.

**Tip:** To ensure trouble-free data transmission, set the GPIB delimiter to EOI.

The **query** command retrieves the content of the specified tag of the currently selected waveform file or the waveform file specified with the <filename>.

See [Chapter 7.4, "Waveform and List Format"](#), on page 432.

By default, the waveform files are saved in the default directory of the instrument (C:\Program Files\Rohde&Schwarz\AMUFirmware\Lists).

To access waveform files located in another directory, the complete file path and file name are required.

**Parameters:**

<Filename> string  
 Specifies the name of the waveform file the binary data will be copied to.  
 The file extension (.wv) may be omitted.

**Setting parameters:**

<Data> block data  
 Contents of the waveform file as a definite length binary block.

**Query parameters:**

<Tag> 'comment' | 'copyright' | 'date' | 'lacpfilter' | 'marker name' |  
 'poweroffset'  
 Identifier of the tag which shall be retrieved from the waveform file.

**Example:**                   **Setting**  
 BB:ARB:WAV:DATA "D:\user\temp\test1", <bin data block>  
 writes the block data to file test1.wv in the D:\user\temp\ directory.

**Example:**                   **Query**  
 BB:ARB:WAV:SEL 'D:\user\wave1.wv'  
 BB:ARB:WAV:DATA? 'comment'  
 queries the content of the 'comment' tag of the currently selected file wave1.wv  
 Response: "Sine wave for test purposes"  
 BB:ARB:WAV:DATA? 'D:\user\temp\test1','comment'  
 queries the content of the comment tag of a specific file test1.wv  
 Response: "Test file"

---

**[:SOURce<hw>]:BB:ARbitrary:WAVeform:DELeTe <Filename>**

Deletes the specified waveform file. If the file is not on the default path, the path must be specified at the same time. The file extension may be omitted. Only files with the file extension \*.wv will be deleted.

**Setting parameters:**

<Filename>                   string

**Example:**                   BB:ARB:WAV:DEL 'D:\user\wave1.wv'  
 deletes waveform file wave1.wv.

**Usage:**                    Setting only

---

**[:SOURce<hw>]:BB:ARbitrary:WAVeform:FREE?**

Queries the free disk space on the default path of the instrument's harddisk.

**Return values:**

<Free>                       integer  
 Range:                    0 to INT\_MAX  
 \*RST:                    1

**Example:**                   MMEM:CDIR 'D:\user\waveform'  
 sets the default directory  
 BB:ARB:WAV:FREE?  
 queries the free disk space in directory

**Usage:**                    Query only

---

**[:SOURce<hw>]:BB:ARbitrary:WAVeform:HDDStreaming:BLEVel?**

Queries the filling level of the streaming buffer.

During normal operation, the streaming buffer level should have a value of 90% .. 100%. Buffer level around 0% indicates a buffer underrun and the signal processing will be interrupted.

Adjustment in the parameter value or state usually results in short decreasing of the streaming buffer level but this buffer state should not be mislead with buffer underrun.

**Return values:**

<BLevel> integer  
 Range: 0 to 100  
 \*RST: 0

**Example:**

BB:ARB:WAV:HDDS:STAT ON  
 enables HDD streaming.  
 BB:ARB:WAV:HDDS:BLEV?  
 queries the streaming buffer level.  
 Response: 94%

**Usage:** Query only

**Manual operation:** See "[Streaming Buffer](#)" on page 306

**[[:SOURce<hw>]:BB:ARbitrary:WAVeform:HDDStreaming:STATe <State>**

Enables/disables the streaming of modulation data direct form the hard drive (HDD).

HDD streaming is recommended for processing of large files that require more ARB memory than the currently installed one.

**Parameters:**

<State> 0 | 1 | OFF | ON  
 \*RST: 0

**Example:**

BB:ARB:WAV:HDDS:STAT ON  
 enables HDD streaming.

**Manual operation:** See "[HDD Streaming](#)" on page 306

**[[:SOURce<hw>]:BB:ARbitrary:WAVeform:POINTs?**

The command queries the number of samples in the waveform file selected using command :ARB:WAV:SEL. Only the file name has to be entered. Only files with the file extension \*.wv will be read out.

**Return values:**

<Points> <waveform filename>  
 Range: 0 to 1000  
 \*RST: 1

**Example:**

BB:ARB:WAV:POINT?  
 queries the number of I/Q values pairs in the waveform file.  
 Response: 401  
 the waveform file contains 401 I/Q values pairs.



**Usage:** Query only

---

**[ :SOURce<hw>]:BB:ARbitrary:WAVeform:SElect <Filename>**

Selects the waveform file. If the file is not on the default path, the path must be specified.

The file extension may be omitted. Only files with the file extension \*.wav will be created or loaded.

**Parameters:**

<Filename> string

**Example:** BB:ARB:WAV:SEL 'D:\user\wave1.wav'  
selects waveform file and loads it.

**Manual operation:** See "Load Waveform" on page 304

---

**[ :SOURce<hw>]:BB:ARbitrary:WAVeform:TAG?**

Queries the content of the specified tag of the waveform file, selected with the command [ :SOURce<hw>]:BB:ARbitrary:WAVeform:SElect.

See also [Chapter 7.4, "Waveform and List Format"](#), on page 432.

**Return values:**

<Tag> string

**Example:** BB:ARB:WAV:SEL 'D:\user\wave1.wav'  
selects waveform file and loads it  
BB:ARB:WAV:TAG? 'comment'  
queries the content of the comment tag  
Response: "Sine wave for test purposes"

**Usage:** Query only

**SOURce:BB:ARB:WSEG Subsystem**

The WSEGment subsystem contains the commands for setting the Multi Segment Waveform Generator.

Section [Chapter 7.4, "Waveform and List Format"](#), on page 432 describes the ARB waveform format and how it is used to transmit waveforms via the IEC bus.

[ :SOURce<hw>]:BB:ARbitrary:WSEGment?.....	546
[ :SOURce<hw>]:BB:ARbitrary:WSEGment:CLOad.....	546
[ :SOURce<hw>]:BB:ARbitrary:WSEGment:CONFigure:BLANK:APPend.....	547
[ :SOURce<hw>]:BB:ARbitrary:WSEGment:CONFigure:CATalog?.....	548
[ :SOURce<hw>]:BB:ARbitrary:WSEGment:CONFigure:CLOCK.....	548
[ :SOURce<hw>]:BB:ARbitrary:WSEGment:CONFigure:CLOCK:MODE.....	548
[ :SOURce<hw>]:BB:ARbitrary:WSEGment:CONFigure:COMMENT.....	549
[ :SOURce<hw>]:BB:ARbitrary:WSEGment:CONFigure:DELeTe.....	549
[ :SOURce<hw>]:BB:ARbitrary:WSEGment:CONFigure:LEVel[:MODE].....	549
[ :SOURce<hw>]:BB:ARbitrary:WSEGment:CONFigure:MARKer:ESEGment.....	550

[SOURce<hw>]:BB:ARbitrary:WSEgment:CONFigure:MARKer:FSEgment.....	550
[SOURce<hw>]:BB:ARbitrary:WSEgment:CONFigure:MARKer:MODE.....	551
[SOURce<hw>]:BB:ARbitrary:WSEgment:CONFigure:OFILe.....	551
[SOURce<hw>]:BB:ARbitrary:WSEgment:CONFigure:SEGMENT:APPend.....	552
[SOURce<hw>]:BB:ARbitrary:WSEgment:CONFigure:SEGMENT:CATalog?.....	552
[SOURce<hw>]:BB:ARbitrary:WSEgment:CONFigure:SELect.....	552
[SOURce<hw>]:BB:ARbitrary:WSEgment:CREate.....	553
[SOURce<hw>]:BB:ARbitrary:WSEgment:NAME?.....	553
[SOURce<hw>]:BB:ARbitrary:WSEgment:NEXT.....	554
[SOURce<hw>]:BB:ARbitrary:WSEgment:NEXT:EXECute.....	554
[SOURce<hw>]:BB:ARbitrary:WSEgment:NEXT:SOURce?.....	554
[SOURce<hw>]:BB:ARbitrary:WSEgment:SEQuence:APPend.....	555
[SOURce<hw>]:BB:ARbitrary:WSEgment:SEQuence:SELect.....	555

---

### [SOURce<hw>]:BB:ARbitrary:WSEgment?

This command queries the currently output segment of the multi segment waveform.

#### Return values:

<WSegment>            integer  
                           Range:     0 to 1023  
                           \*RST:     0

#### Example:

BB:ARB:WSEG?  
 queries the currently output segment.  
 Response 2  
 segment 2 is currently output.

**Usage:**                Query only

**Manual operation:**   See "Current Segment" on page 313

---

### [SOURce<hw>]:BB:ARbitrary:WSEgment:CLOad <FilenameInput>

Creates a multi segment waveform using the current entries of the specified configuration file.

This multi segment waveform is saved with the file name specified in the configuration file. The file extension is \*.wv. ARB is activated, the new multi segment waveform is loaded and the first segment is output in accordance to the trigger settings.

#### Setting parameters:

<FilenameInput>        string

**Example:**

```
MMEM:CDIR 'D:\user\'
sets the default directory.
BB:ARB:WSEG:CONF:SEL 'multi_sin'
creates the configuration file multi_sin.inf_mswv in the
default directory.
BB:ARB:WSEG:CONF:SEGM:APP 'sinus1'
includes waveform sinus1.wv as segment 1 in the configura-
tion file. The waveform must be available in the default directory.
BB:ARB:WSEG:CONF:SEGM:APP 'sinus2'
includes waveform sinus2.wv as segment 2 in the configura-
tion file. The waveform must be available in the default directory.
BB:ARB:WSEG:CONF:OFIL 'mseg1_2'
defines the file name mseg1_2.wv for the multi segment wave-
form.
BB:ARB:WSEG:CLO 'D:\user\multi_sin.inf_mswv'
creates multi segment waveform mseg1_2.wv using the set-
tings of the configuration file multi_sin.inf_mswv.
The new multi segment waveform is loaded and ARB is activa-
ted.
```

**Usage:** Setting only

**Manual operation:** See ["Save List"](#) on page 335

**[[:SOURce<hw>]:BB:ARbitrary:WSEgment:CONFigure:BLANk:APPend**  
 <SampCount>, <Frequency>

Adds a blank segment to the multi segment file.

**Setting parameters:**

<SampCount>	float
	Specifies the number of samples.
	Range: 512 to 1E7
	Increment: 1
	*RST: 1000
<Frequency>	float
	Determines the clock rate.
	Range: 400 Hz to Max (depends on instrument type)
	Increment: 0.001
	*RST: 1E8

**Example:**

```
SOUR:BB:ARB:WSEG:CONF:SEL "MSegFile"
selects a multi segment file.
SOUR:BB:ARB:WSEG:CONF:BLAN:APP 1000,100000000
adds a blank segment with 1000 samples and 100 MHz clock
rate to the selected multi segment file
```

**Usage:** Setting only

**Manual operation:** See ["Clock Rate"](#) on page 332

**[[:SOURce<hw>]:BB:ARbitrary:WSEgment:CONFigure:CATalog?**

Queries the available configuration files in the specified default directory. The configuration files are used to create multi segment waveform files.

**Return values:**

<Catalog>                    string

**Example:**

```
MMEM:CDIR 'D:\user\waveform'
sets the default directory.
BB:ARB:WSEG:CONF:CAT?
reads out all the configuration files in the default directory.
Response: mult1, multi2
the directory contains the configuration files multi1.inf_mswv
and multi2.inf_mswv.
```

**Usage:**                    Query only

**Manual operation:**    See "[Load List](#)" on page 335

**[[:SOURce<hw>]:BB:ARbitrary:WSEgment:CONFigure:CLOCK <Clock>**

This command defines the clock rate used for multi segment waveform output in case of Clock Mode "User" (:BB:ARB:WSEG:CONF:CLOCK:MODE USER).

**Parameters:**

<Clock>                    float  
                               Increment: 1E-3  
                               \*RST:        max SampleRate

**Example:**

```
BB:ARB:WSEG:CONF:CLOC:MODE USER
selects Clock Mode User.
BB:ARB:WSEG:CONF:CLOC 50MHz
defines a clock rate of 50 MHz.
```

**Manual operation:**    See "[User Clock Rate](#)" on page 334

**[[:SOURce<hw>]:BB:ARbitrary:WSEgment:CONFigure:CLOCK:MODE <Mode>**

Selects the clock rate mode for the multi segment waveform.

**Parameters:**

<Mode> UNCHanged | HIGHest | USER

**UNCHanged**

The segments are output with the clock rate defined in the waveform file.

**HIGHest**

The segments are output at the highest available clock rate.

**USER**

The segments are output with the clock rate defined with command `[ :SOURce<hw> ] :BB:ARBitrary:WSEgment: CONFigure:CLOCk`

\*RST: UNCHanged

**Example:**

`BB:ARB:WSEG:CONF:CLOC:MODE UNCH`

selects clock mode unchanged. The segments are output with the clock rate defined in the waveform file.

**Manual operation:** See "[Clock](#)" on page 333

**[ :SOURce<hw> ] :BB:ARBitrary:WSEgment:CONFigure:COMment <Comment>**

This command enters a comment for the configuration file. The configuration file must be specified with command `:BB:ARB:WSEG:CONF:SEL`.

**Parameters:**

<Comment> string

**Example:**

`BB:ARB:WSEG:CONF:COMM <3gpp_up>`

enters comment "3gpp\_up".

**Manual operation:** See "[Comment](#)" on page 335

**[ :SOURce<hw> ] :BB:ARBitrary:WSEgment:CONFigure:DElete <Filename>**

Deletes the configuration file. The configuration files are used to create multi segment waveform files.

**Setting parameters:**

<Filename> string

**Example:**

`MMEM:CDIR 'D:\user\waveform'`

sets the default directory.

`BB:ARB:WSEG:CONF:DEL 'multil'`

deletes configuration file `multil.inf_mswv`.

**Usage:**

Setting only

**Manual operation:** See "[Delete](#)" on page 332

**[ :SOURce<hw> ] :BB:ARBitrary:WSEgment:CONFigure:LEVel[ :MODE ] <Mode>**

This command selects the level mode for the multi segment waveform.

**Parameters:**

&lt;Mode&gt; UNCHanged | ERMS

**UNCHanged**

The segments are output exactly as defined in the files.

**ERMS**

The segments are output so that all segments have the same rms value.

\*RST: UNCHanged

**Example:**

BB:ARB:WSEG:CONF:LEV:MODE UNCH

selects level mode unchanged. The segments are output as defined in the waveform file.

**Manual operation:** See "[Level](#)" on page 333[:SOURce<hw>]:BB:ARbitrary:WSEGment:CONFigure:MARKer:ESEGment  
<Mode>

Enables/disables the generation of an additional marker restart signal in the output waveform file.

If additional marker generation is enabled, the existing marker signals in the individual segment waveform files are not considered.

**Parameters:**

&lt;Mode&gt; OFF | MRK1 | MRK2 | MRK3 | MRK4

**OFF**

No additional marker is generated.

**MRK1|MRK2|MRK3|MRK4**

Generates a restart marker signal at the beginning of each segment for the corresponding marker.

The segment begin is defined by the low-high slope of the marker. This applies for switching between two segments as well as in case of segment replay.

\*RST: OFF

**Example:**

BB:ARB:WSEG:CONF:SEL 'ConfComm'

BB:ARB:WSEG:CONF:MARK:ESEG MRK3

**Manual operation:** See "[Segment Restart](#)" on page 334[:SOURce<hw>]:BB:ARbitrary:WSEGment:CONFigure:MARKer:FSEGment  
<Mode>

Enables/disables the generation of an additional marker restart signal in the output waveform file.

If additional marker generation is enabled, the existing marker signals in the individual segment waveform files are not considered.

**Parameters:**

<Mode> OFF | MRK1 | MRK2 | MRK3 | MRK4

**OFF**

No additional marker is generated.

**MRK1|MRK2|MRK3|MRK4**

Generates a restart marker signal at the beginning of the first segment for the corresponding marker.

Use this setting to generate a restart marker for the complete sequence.

\*RST: OFF

**Example:**

```
BB:ARB:WSEG:CONF:SEL 'ConfComm'
BB:ARB:WSEG:CONF:MARK:FSEG MRK3
```

**Manual operation:** See ["Sequence Restart"](#) on page 334

**[:SOURce<hw>]:BB:ARbitrary:WSEGment:CONFigure:MARKer:MODE <Mode>**

Defines the way the marker information within the separate segments is processed.

**Parameters:**

<Mode> IGNore | TAKE

**IGNore**

The marker information carried in the individual segment waveform files is not considered.

**TAKE**

The output waveform file contains the marker information as configured in the individual waveform files.

\*RST: TAKE

**Example:**

```
BB:ARB:WSEG:CONF:SEL 'ConfComm'
BB:ARB:WSEG:CONF:MARK:MODE TAKE
```

**Manual operation:** See ["Segment Marker"](#) on page 334

**[:SOURce<hw>]:BB:ARbitrary:WSEGment:CONFigure:OFILe <OFile>**

Defines the file name for the multi segment waveform. The file extension is \*.wv.

**Parameters:**

<OFile> string

**Example:**

```
MMEM:CDIR 'D:\user\waveform'
sets the default directory.
BB:ARB:WSEG:CONF:SEL 'multil'
creates the configuration file multil.inf_mswv in default
directory.
BB:ARB:WSEG:CONF:OFIL 'mseg1_2'
defines the file name mseg1_2.wv for the multi segment wave-
form file created using configuration file multil.inf_mswv.
```

**Manual operation:** See "Output file" on page 335

---

**[:SOURce<hw>]:BB:ARbitrary:WSEgment:CONFigure:SEGMent:APPend**  
<Waveform>

Appends the specified waveform to the configuration file.

**Setting parameters:**

<Waveform>            string

**Example:**            MMEM:CDIR 'D:\user\waveform'  
sets the default directory  
BB:ARB:WSEG:CONF:SEL 'new'  
creates the configuration file `new.inf_mswv` in the default  
directory.  
BB:ARB:WSEG:CONF:SEGM:APP 'arb1'  
appends waveform `arb1.wv` to configuration file `new`. Wave-  
form `arb1` will be the first segment of a multi segment waveform  
created with configuration file `new`.

**Usage:**                Setting only

**Manual operation:** See "Append" on page 332

---

**[:SOURce<hw>]:BB:ARbitrary:WSEgment:CONFigure:SEGMent:CATalog?**

Queries the segments of the currently selected configuration file.

**Return values:**

<Catalog>               string

**Example:**            MMEM:CDIR 'D:\user\waveform'  
sets the default directory.  
BB:ARB:WSEG:CONF:SEL 'multi\_sin'  
selects the configuration file `multi_sin.inf_mswv`.  
BB:ARB:WSEG:CONF:SEGM:CAT?  
queries the segments of the selected configuration file.  
Response: `arb4, arb2`  
The configuration file includes the segments `arb4.wv` and  
`arb2.wv`.

**Usage:**                Query only

**Manual operation:** See "Append" on page 332

---

**[:SOURce<hw>]:BB:ARbitrary:WSEgment:CONFigure:SELEct <Filename>**

Selects the configuration file in the default directory.

A path can also be specified, in which case the files in the specified directory are selected. If a configuration file with the specified name does not yet exist, it is created. The file extension may be omitted. Only files with the file extension `*.inf_mswv` will be selected or created.



**Parameters:****<Filename>** string**Example:**

```
MMEM:CDIR 'D:\user\waveform'
sets the default directory.
BB:ARB:WSEG:CONF:SEL 'new'
create configuration file new.inf_mswv in the default directory.
```

**Manual operation:** See "[Load List](#)" on page 335**[[:SOURce<hw>]:BB:ARbitrary:WSEGment:CREate <FilenameInput>**

Creates a multi segment waveform using the current settings of the specified configuration file. The multi segment waveform is saved into the file defined in the configuration file. The file extension is \*.wv.

**Setting parameters:****<FilenameInput>** string**Example:**

```
MMEM:CDIR 'D:\user\'
sets the default directory
BB:ARB:WSEG:CONF:SEL 'new'
creates the configuration file new.inf_mswv in the default
directory.
BB:ARB:WSEG:CONF:SEGM:APP 'arb1.wv'
includes waveform arb1.wv as segment 1 in the configuration
file. The waveform must be available in the default directory.
BB:ARB:WSEG:CONF:OFIL 'multi_wv1'
defines the file name multi_wv1.wv for the multi segment
waveform.
BB:ARB:WSEG:CRE 'D:\user\new.inf_mswv'
creates multi segment waveform multi_wv1.wv using the set-
tings of the configuration file new.inf_mswv.
```

**Usage:** Setting only**Manual operation:** See "[Save List](#)" on page 335**[[:SOURce<hw>]:BB:ARbitrary:WSEGment:NAME?**

This command queries the name of the waveform of the currently output segment of the multi segment waveform.

**Return values:****<Name>** string**Example:**

```
BB:ARB:WSEG:NAME?
queries the currently output segment.
```

**Usage:** Query only**Manual operation:** See "[Current Segment](#)" on page 313

---

**[:SOURce<hw>]:BB:ARbitrary:WSEgment:NEXT <Next>**

Selects the segment to be output.

**Parameters:**

<Next> float  
 Range: 0 to 1023  
 \*RST: 0

**Example:**

```
MMEM:CDIR 'D:\user\waveform'
sets the default directory.
BB:ARB:WSEG:NEXT 2
selects segment 2 to be output.
BB:ARB:TRIG:SMOD NEXT
selects extended trigger mode next, i.e. the segment specified
with command :BB:ARB:WSEG:NEXT will be output.
BB:ARB:SEQ AUTO
selects trigger mode Auto.
BB:ARB:WAV:SEL 'multi_wv1'
loads multi segment waveform multi_wv1.wv. Generation of
segment 2 starts.
BB:ARB:WSEG:NEXT 3
switched at once to output of segment 3.
```

**Manual operation:** See "[Next Segment](#)" on page 313

---

**[:SOURce<hw>]:BB:ARbitrary:WSEgment:NEXT:EXECute**

Triggers manually switchover to the subsequent segment in the mutli segment file. A manual trigger can be executed only when an internal next segment source (BB:ARB:WSEG:NEXT:SOUR INT) has been selected.

To perform a switchover to any segment within the multi segment file, select the next segment with the command BB:ARB:WSEG:NEXT.

This command is disabled, if a sequencing play list is enabled.

**Example:**

```
BB:ARB:WSEG:NEXT:SOUR INT
selects internal next segment source.
BB:ARB:WSEG:NEXT 2
selects segment 2 to be output.
BB:ARB:WSEG:NEXT:EXEC
executes a switchover to the next segment.
```

**Usage:** Event

**Manual operation:** See "[Execute Next Segment](#)" on page 318

---

**[:SOURce<hw>]:BB:ARbitrary:WSEgment:NEXT:SOURce?**

Queries the next segment source.

**Return values:**

<Source>           INTernal  
 \*RST:            INTernal

**Example:**

BB:ARB:WSEG:NEXT:SOUR?  
 queries the next segment source.

**Usage:**

Query only

**Manual operation:** See "[Next Segment Source](#)" on page 317

**[:SOURce<hw>]:BB:ARBitrary:WSEgment:SEquence:APPend <State>, <Segment>, <Count>, <Next>**

Appends a new segment to the selected sequencing play list.

**Setting parameters:**

<State>            ON | OFF  
 activates/deactivates the appended segment  
 \*RST:            ON

<Segment>         integer  
 indicates the number of the segment as in the multi segment waveform file  
 Range:         0 to SegmentCount - 1

<Count>           integer  
 defines how many times this segment is repeated  
 Range:         1 to 65535

<Next>            NEXT | BLANK | ENDLess | SEG0 | SEG1 | ... | SEG31 | 0...maxSegment  
 determines the action after completing the current segment, like for instance which segment is processed after the processing of the current one is finished.

**Example:**

BB:ARB:WSEG:SEQ:SEL 'D:\user\play\_list\_1'  
 selects the sequencing list `play_list_1.wvs`.  
 BB:ARB:WSEG:SEQ:APP ON,3,15,BLANK  
 appends the segment number 3 as a new segment to the sequencing list; this segment is activated and will be repeated 15 times and followed by a blank segment.

**Usage:**

Setting only

**Manual operation:** See "[Append](#)" on page 339

**[:SOURce<hw>]:BB:ARBitrary:WSEgment:SEquence:SElect <Filename>**

Selects the sequencing list (files with extension `*.wvs`)

**Parameters:**

<Filename> string

**Example:**

BB:ARB:WSEG:SEQ:SEL 'D:\user\play\_list\_1'  
selects the sequencing list `play_list_1.wvs`.

**Manual operation:** See "[Sequencing List](#)" on page 318

### 7.15.2.3 SOURce:BB:DM Subsystem

The commands in the `SOURce:BB:DM` subsystem are described in two sections, separated into configuring digital modulation and lists for digital modulation.

#### DM General Remote-Control Commands

The following section contains the commands for generating the digital modulation signal.

• <a href="#">Common Settings</a> .....	556
• <a href="#">Clock Settings</a> .....	560
• <a href="#">Trigger Settings</a> .....	562
• <a href="#">Marker Settings</a> .....	571
• <a href="#">Filter Settings</a> .....	573
• <a href="#">Modulation Settings</a> .....	577
• <a href="#">Power Ramp</a> .....	580

#### Common Settings

<code>[SOURce&lt;hw&gt;]:BB:DM:PATtern</code> .....	556
<code>[SOURce&lt;hw&gt;]:BB:DM:PRBS[:LENGth]</code> .....	557
<code>[SOURce&lt;hw&gt;]:BB:DM:PRESet</code> .....	557
<code>[SOURce&lt;hw&gt;]:BB:DM:SOURce</code> .....	557
<code>[SOURce&lt;hw&gt;]:BB:DM:SRATe</code> .....	558
<code>[SOURce&lt;hw&gt;]:BB:DM:STANdard</code> .....	559
<code>[SOURce&lt;hw&gt;]:BB:DM:STATe</code> .....	559
<code>[SOURce&lt;hw&gt;]:BB:DM:SWITching:SOURce</code> .....	559
<code>[SOURce&lt;hw&gt;]:BB:DM:SWITching:STATe</code> .....	560

---

#### `[SOURce<hw>]:BB:DM:PATtern <Pattern>`

The command selects the data pattern for the internal data when `PATtern` is selected as the data source. The maximum length is 64 bits.

**Parameters:**

<Pattern> string  
Range: #B0,1 to #B111...1,64  
\*RST: #B0,1

**Example:**

BB:DM:SOUR PATT  
selects `Pattern` as the data source for digital modulation.  
BB:DM:PATt #B01110111010101010,17  
generates the user-defined sequence of 0/1 data.

---

**[ :SOURce<hw> ]:BB:DM:PRBS[:LENGth] <Length>**

The command defines the length of the pseudo-random sequence in accordance with the following equation:

$$\text{Length} = (2^{\text{Length}}) - 1$$

**Parameters:**

<Length>            9 | 11 | 15 | 16 | 20 | 21 | 23 | PN9 | PN11 | PN15 | PN16 |  
 PN20 | PN21 | PN23  
 \*RST:                9

**Example:**

```
BB:DM:SOUR PRBS
```

The internal pseudo-random generator is used as the data source.

```
BB:DM:PRBS 9
```

An internal pseudo-random sequence of 511 bits will be generated.

**Manual operation:** See ["Data Source"](#) on page 271

---

**[ :SOURce<hw> ]:BB:DM:PRESet**

Sets the default settings for digital modulation (\*RST values specified for the commands).

Not affected is the state set with the command `SOURce<hw>:BB:DM:STATe`

**Example:**            `SOURce1:BB:DM:PRESet`

**Usage:**                Event

**Manual operation:** See ["Set To Default"](#) on page 269

---

**[ :SOURce<hw> ]:BB:DM:SOURce <Source>**

The command selects the data source.

**Parameters:**

<Source> ZERO | ONE | PRBS | PATtern | DLISt | SERial | PARallel

**ZERO**

An internally generated 0 data sequence is used.

**ONE**

An internally generated 1 data sequence is used.

**PRBS**

The pseudo-random sequence generator is used as the data source. The length of the random sequence is defined with the aid of command `SOURce:BB:DM:PRBS`.

**PATtern**

Internally generated data with a fixed pattern is used. The data pattern is defined using command `SOURce:BB:DM:PATtern`.

**DLISt**

Data from the selected data list is used.

**SERial**

External data from the serial interface is used.  
In case of two-path instruments, this affects path A.

**PARallel**

External data from the serial interface is used.  
In case of two-path instruments, this affects path A.

\*RST: PRBS

**Example:**

```
BB:DM:SOUR DLIS
the internal data generator is used.
BB:DM:DLIS:SEL 'test'
the data list test.dm_iqd is used.
```

**Manual operation:** See "[Data Source](#)" on page 271

**[[:SOURce<hw>]:BB:DM:SRATe <SRate>**

Sets the symbol rate. The value range is dependent on the selected modulation type. On changing to an FSK modulation type, excessively high values are automatically limited to the maximum value that can be set for FSK (see data sheet). The symbol rate can be entered in Hz/kHz/MHz or Symb/s / kSymb/s and MSymb/s.

When a standard is selected (`DM:STANDARD`), the symbol rate is automatically set to the appropriate default value.

The value range is dependent on the selected modulation type (`:BB:DM:FORM`). When a standard is selected (`:BB:DM:STAN`), the symbol rate is set to the default value.

**Parameters:**

<SRate> float  
Range: 400 to depends on hardware  
Increment: 0.001  
\*RST: 270833.333  
Default unit: Hz

**Example:** `BB:DM:SRAT 10 MHz`  
sets a symbol rate of 10 MHz.

**Manual operation:** See "[Symbol Rate](#)" on page 274

**[[:SOURce<hw>]:BB:DM:STANdard <Standard>**

Selects the standard.

After selection, modulation parameters "Modulation Type" (:BB:DM:FORMat), "Symbol Rate" (:BB:DM:SRATe), "Filter" (:BB:DM:FILTer:TYPE and :BB:DM:FILTer:PARAMeter:...) and "Coding" (:BB:DM:CODing) are automatically set in accordance with the standard.

The USER parameter cannot be set. A query returns this value if a user-defined Custom Dig Mod setting was loaded or if one of the associated settings was changed subsequent to the selection of a standard. The user defined settings are stored and loaded with commands :BB:DM:STAN:ULIS:... (see "[DM Lists](#)" on page 582).

**Parameters:**

<Standard> USER | BLUetooth | DECT | ETC | GSM | GSMEdge | NADC | PDC | PHS | TETRa | W3GPP | TDSCdma | CFORward | CREVerse | WORLdspace | TFTS | APCOPH1C4fm | APCOPH1CQpsk | APCOPH2HCpm | APCOPH2HDQpsk | APCOPH2HD8PSKW | APCOPH2HD8PSKN | APCOPH1Lsm | APCOPH1Wcqpsk  
\*RST: GSM

**Example:** `BB:DM:STAN DECT`  
selects digital modulation according to the DECT standard.

**Manual operation:** See "[Set acc. to Standard](#)" on page 272

**[[:SOURce<hw>]:BB:DM:STATe <State>**

Enables/disables digital modulation. Switching on digital modulation turns off all the other digital standards in the same signal path.

**Parameters:**

<State> 0 | 1 | OFF | ON  
\*RST: 0

**Example:** `SOURce1:BB:DM:STATe ON`

**Manual operation:** See "[State](#)" on page 269

**[[:SOURce<hw>]:BB:DM:SWITching:SOURce <Source>**

Selects the source of the CW control signal for switching between a modulated and an unmodulated signal.

**Parameters:**

<Source> INTernal | EXTernal

**INTernal**

The CW signal in the control list is used for the control.  
The internal signal can be output on one of the user interfaces.

**EXTernal**

The control signal on the CW pin of the AUX I/Q connector is used.

In case of two-path instruments, path A and B.

\*RST: INTernal

**Example:**

BB:DM:SWIT INT  
the CW signal in the control list is used for the control.

**Manual operation:** See "Source Mod - CW" on page 277

**[:SOURce<hw>]:BB:DM:SWITching:STATe <State>**

Enables switching between a modulated and an unmodulated signal.

**Parameters:**

<State> 0 | 1 | OFF | ON

\*RST: 0

**Example:**

BB:DM:SWIT:STAT INT  
CW switching is active.

**Manual operation:** See "State Mod - CW" on page 277

**Clock Settings**

<a href="#">[:SOURce&lt;hw&gt;]:BB:DM:CLOCK:MODE.....</a>	560
<a href="#">[:SOURce&lt;hw&gt;]:BB:DM:CLOCK:MULTiplier.....</a>	561
<a href="#">[:SOURce&lt;hw&gt;]:BB:DM:CLOCK:SOURce.....</a>	561

**[:SOURce<hw>]:BB:DM:CLOCK:MODE <Mode>**

The command enters the type of externally supplied clock (:BB:DM:CLOCK:SOURce EXTernal).

The bit clock and the symbol clock differ only in the case of modulations that have more than two states, i.e. that require more than one bit for encoding each state. When MSYMBOL is used, a multiple of the symbol clock is supplied via the CLOCK connector and the symbol clock is derived internally from this. The multiplier is entered with the command :BB:DM:CLOCK:MULTiplier.

It is not possible to select BIT and MSYMBOL in the case of an external serial or external parallel data source (SOUR:BB:DM:SOUR SER and PAR).

For two-path instruments, the only numerical suffix allowed for SOURce is 1, since the external clock source is permanently allocated to path A.



**Parameters:**

<Mode> SYMBol | MSYMBOL | BIT  
 \*RST: SYMBol

**Example:**

BB:DM:CLOC:MODE SYMB  
 selects clock type Symbols, i.e. the supplied clock is a symbol clock.

**Manual operation:** See "[Clock Mode](#)" on page 295

**[[:SOURce<hw>]:BB:DM:CLOCK:MULTIPLIER <Multiplier>**

The command specifies the multiplier for clock type Multiple Symbols (BB:DM:CLOCK:MODE MSYM) in the case of an external clock source.

For two-path instruments, the only numerical suffix allowed for SOURce is 1, since the external clock source is permanently allocated to path A.

**Parameters:**

<Multiplier> integer  
 Range: 1 to 64  
 \*RST: 4

**Example:**

BB:DM:CLOC:SOUR EXT  
 selects the external clock source. The clock is supplied via the CLOCK connector.  
 BB:DM:CLOC:MODE MSYM  
 selects clock type Multiple Symbols, i.e. the supplied clock has a rate which is a multiple of the symbol rate.  
 BB:DM:CLOC:MULT 12  
 the multiplier for the external clock rate is 12.

**Manual operation:** See "[Symbol Clock Multiplier](#)" on page 296

**[[:SOURce<hw>]:BB:DM:CLOCK:SOURCE <Source>**

The command selects the source for the digital modulation clock.

For two-path instruments, selecting COUPLed and EXTERNAL is only possible for path A, since the external clock source is permanently allocated to path A; clock source AINT is only allowed for path B.

**Parameters:**

<Source>                   INTernal | EXTernal | COUPled | AINTernal

**INTernal**

The internal clock reference is used.

**EXTernal**

The external clock reference is supplied to the CLOCK connector.

**COUPled**

The clock reference (internal or external) is selected automatically according to the selected data source, i.d. if the data source changes (BB:DM:DATA:SOUR) the clock source is automatically changed correspondingly as well.

\*RST:           INTernal

**Example:**

BB:DM:CLOC:SOUR INT  
selects the internal clock reference.

**Manual operation:** See "Clock Source" on page 295

**Trigger Settings**

The numeric suffix to OUTPut distinguishes between the available markers.

[SOURce<hw>]:BB:DM:TRIGger:ARM:EXECute.....	562
[SOURce<hw>]:BB:DM:TRIGger:EXECute.....	563
[SOURce<hw>]:BB:DM:TRIGger:EXTernal:SYNChronize:OUTPut.....	563
[SOURce<hw>]:BB:DM:TRIGger:OBASeband:DELay.....	564
[SOURce<hw>]:BB:DM:TRIGger:OBASeband:RDELay?.....	564
[SOURce<hw>]:BB:DM:TRIGger:OBASeband:TDELay.....	565
[SOURce<hw>]:BB:DM:TRIGger:OBASeband:INHibit.....	565
[SOURce<hw>]:BB:DM:TRIGger:OUTPut:DELay:FIXed.....	566
[SOURce<hw>]:BB:DM:TRIGger:OUTPut<ch>:DELay.....	566
[SOURce<hw>]:BB:DM:TRIGger:OUTPut<ch>:DELay:MINimum?.....	566
[SOURce<hw>]:BB:DM:TRIGger:OUTPut<ch>:DELay:MAXimum?.....	566
[SOURce<hw>]:BB:DM:TRIGger:RMODE?.....	567
[SOURce<hw>]:BB:DM:TRIGger:SLENgth.....	567
[SOURce<hw>]:BB:DM:TRIGger:SOURce.....	568
[SOURce<hw>]:BB:DM:TRIGger:DELay:UNIT.....	568
[SOURce<hw>]:BB:DM:TRIGger[:EXTernal<ch>]:DELay.....	568
[SOURce<hw>]:BB:DM:TRIGger[:EXTernal]:TDELay.....	569
[SOURce<hw>]:BB:DM:TRIGger[:EXTernal]:RDELay?.....	569
[SOURce<hw>]:BB:DM:TRIGger[:EXTernal<ch>]:INHibit.....	569
[SOURce<hw>]:BB:DM[:TRIGger]:SEQuence.....	570

**[SOURce<hw>]:BB:DM:TRIGger:ARM:EXECute**

The command stops signal generation for trigger modes Armed\_Auto and Armed\_Ret-rigger. A subsequent internal or external trigger event restart signal generation.

**Example:** BB:DM:TRIG:SOUR INT  
sets internal triggering.  
BB:DM:TRIG:SEQ ARET  
sets Armed\_Retrigger mode, i.e. every trigger event causes signal generation to restart.  
BB:DM:TRIG:EXEC  
executes a trigger, signal generation is started.  
BB:DM:TRIG:ARM:EXEC  
signal generation is stopped.  
BB:DM:TRIG:EXEC  
executes a trigger, signal generation is started again.

**Usage:** Event

**Manual operation:** See "[Arm](#)" on page 292

#### **[SOURce<hw>]:BB:DM:TRIGger:EXECute**

Executes a trigger. The internal trigger source must be selected using the command: BB:DM:TRIG:SOUR INT and a trigger mode other than AUTO must be selected using the command :BB:DM:TRIG:SEQ.

**Example:** BB:DM:TRIG:SOUR INT  
sets internal triggering.  
BB:DM:TRIG:SEQ RETR  
sets Retrigger mode, i.e. every trigger event causes signal generation to restart.  
BB:DM:TRIG:EXEC  
executes a trigger.

**Usage:** Event

**Manual operation:** See "[Execute Trigger](#)" on page 280

#### **[SOURce<hw>]:BB:DM:TRIGger:EXTernal:SYNChronize:OUTPut <Output>**

(enabled for "Trigger Source" External)

Enables/disables output of the signal synchronous to the external trigger event.

**Parameters:**

&lt;Output&gt;

0 | 1 | OFF | ON

**ON**

The signal calculation starts simultaneously with the external trigger event but because of the instrument's processing time the first samples are cut off and no signal is outputted. After elapsing of the internal processing time, the output signal is synchronous to the trigger event.

**OFF**

The signal output begins after elapsing of the processing time and starts with sample 0, i.e. the complete signal is outputted. This mode is recommended for triggering of short signal sequences with signal duration comparable with the processing time of the instrument.

\*RST: 1

**Example:**

BB:DM:TRIG:SOUR EXT

sets external triggering.

BB:DM:TRIG:EXT:SYNC:OUTP ON

enables synchronous output to external trigger

**Manual operation:** See "[Sync. Output to External Trigger](#)" on page 292**[[:SOURce<hw>]:BB:DM:TRIGger:OBASeband:DELay <Delay>**

Specifies the trigger delay (expressed as a number of symbols) for triggering by the trigger signal from the second path (two-path instruments only).

**Parameters:**

&lt;Delay&gt;

float

Range: 0 to 65535

Increment: 0.01

\*RST: 0

Default unit: symbol

**Example:**

BB:DM:TRIG:SOUR OBAS

sets for path A the internal trigger executed by the trigger signal from the second path (path B).

BB:DM:TRIG:OBAS:DEL 50

sets a delay of 50 symbols for the trigger.

**Manual operation:** See "[Trigger Delay](#)" on page 293**[[:SOURce<hw>]:BB:DM:TRIGger:OBASeband:RDELay?**

Queries the time a trigger event from the other path is delayed.

**Return values:**

<ObResTimeDelay> float  
 Range: 0 to 688  
 Increment: 250E-12  
 \*RST: 0

**Example:** see [:SOURce<hw>]:BB:DM:TRIGger:DElay:UNIT  
 on page 568

**Usage:** Query only

**Manual operation:** See "Actual Trigger Delay" on page 294

**[[:SOURce<hw>]:BB:DM:TRIGger:OBASeband:TDElay <ObasTimeDelay>**

Specifies the trigger delay for triggering by the signal from the other path.

**Parameters:**

<ObasTimeDelay> float  
 Range: 0 to 688  
 Increment: 250E-12  
 \*RST: 0

**Example:** see [:SOURce<hw>]:BB:DM:TRIGger:DElay:UNIT  
 on page 568

**Manual operation:** See "Trigger Delay" on page 293

**[[:SOURce<hw>]:BB:DM:TRIGger:OBASeband:INHibit <Inhibit>**

Specifies the number of symbols by which a restart is to be inhibited following a trigger event. This command applies only for triggering by the second path (two-path instruments only).

**Parameters:**

<Inhibit> integer  
 Range: 0 to 67108863  
 \*RST: 0  
 Default unit: symbol

**Example:** BB:DM:TRIG:SOUR OBAS  
 sets for path A the internal trigger executed by the trigger signal from the second path (path B).  
 BB:DM:TRIG:INH 200  
 sets a restart inhibit for 200 symbols following a trigger event.

**Manual operation:** See "Trigger Inhibit" on page 294

**[ :SOURce<hw>]:BB:DM:TRIGger:OUTPut:DELay:FIXed <Fixed>**

The command restricts the marker delay setting range to the dynamic range. In this range the delay can be set without restarting the marker and signal. If a delay is entered in setting ON but is outside this range, the maximum possible delay is set and an error message is generated.

The numeric suffix in `OUTPut` has no significance for this command, since the setting always affects every marker.

**Parameters:**

<Fixed>                    0 | 1 | OFF | ON  
\*RST:                    0

**Example:**

`BB:DM:TRIG:OUTP:DEL:FIX ON`  
restricts the marker signal delay setting range to the dynamic range.

**Manual operation:** See "[Marker x Delay](#)" on page 295

**[ :SOURce<hw>]:BB:DM:TRIGger:OUTPut<ch>:DELay <Delay>**

Defines the delay between the signal on the marker outputs and the start of the signal, expressed in terms of symbols. Command `[ :SOURce<hw>]:BB:DM:TRIGger:OUTPut:DELay:FIXed` can be used to restrict the range of values to the dynamic range, i.e. the range within which a delay of the marker signals can be set without restarting the marker and signal.

**Parameters:**

<Delay>                    float  
Range:                    0 to 16777215  
Increment:                0.001  
\*RST:                    0

**Example:**

`BB:DM:TRIG:OUTP2:DEL 16`  
sets a delay of 16 symbols for the signal on connector MARKER 2.

**Manual operation:** See "[Marker x Delay](#)" on page 295

**[ :SOURce<hw>]:BB:DM:TRIGger:OUTPut<ch>:DELay:MINimum?****[ :SOURce<hw>]:BB:DM:TRIGger:OUTPut<ch>:DELay:MAXimum?**

Queries the maximum marker delay for setting `:BB:DM:TRIG:OUTP:DEL:FIX ON`.

**Return values:**

<Maximum>                float  
Range:                    0 to 16777215  
Increment:                1E-3  
\*RST:                    2000

**Example:** `BB:DM:TRIG:OUTP:DEL:FIX ON`  
restricts the marker signal delay setting range to the dynamic range.

`BB:DM:TRIG:OUTP:DEL:MAX`  
queries the maximum of the dynamic range.

Response: 2000  
the maximum for the marker delay setting is 2000 symbols.

**Usage:** Query only

**Manual operation:** See "[Marker x Delay](#)" on page 295

#### `[:SOURce<hw>]:BB:DM:TRIGger:RMODE?`

Queries the status of signal generation for all trigger modes with digital modulation on.

**Return values:**

<RMode>

STOP | RUN

**RUN**

The signal is generated. A trigger event occurred in the triggered mode.

**STOP**

The signal is not generated. A trigger event did not occur in the triggered modes, or signal generation was stopped by the command `:BB:DM:TRIG:ARM:EXECute` (armed trigger modes only).

**Example:** `BB:DM:TRIG:SOUR EXT`  
sets external triggering

`BB:DM:TRIG:MODE ARET`  
selects the Armed\_Retrigger mode

`BB:DM:TRIG:RMODE?`  
queries the current status of signal generation.

Response: RUN  
the signal is generated, an external trigger was executed.

**Usage:** Query only

**Manual operation:** See "[Running - Stopped](#)" on page 291

#### `[:SOURce<hw>]:BB:DM:TRIGger:SLENgth <SLength>`

Defines the length of the signal sequence to be output in the "Single" trigger mode.

**Parameters:**

<SLength>

integer

Range: 1 to 4294967295

\*RST: 1000

Default unit: symbol

**Example:** `BB:DM:SEQ SING`  
sets trigger mode Single.  
`BB:DM:TRIG:SLen 200`  
sets a sequence length of 200 symbols. 200 symbols will be output after the next trigger event.

**Manual operation:** See "[Trigger Signal Duration](#)" on page 291

**[:SOURce<hw>]:BB:DM:TRIGger:SOURce <Source>**

Selects the trigger source.

**Parameters:**

<Source>            `INTernal|OBASeband|BEXTernal|EXTernal`  
**INTernal**  
manual trigger or \*TRG.  
**EXTernal | BEXTernal**  
trigger signal on the TRIGGER 1/2 connector.  
**OBASeband**  
trigger signal from the other path  
\*RST:            `INTernal`

**Example:** `SOURce1:BB:DM:TRIGger:SOURce EXTernal`  
sets external triggering via the TRIGGER 1 connector.

**Manual operation:** See "[Trigger Source](#)" on page 292

**[:SOURce<hw>]:BB:DM:TRIGger:DELay:UNIT <TrigDelUnit>**

Determines the units in that the trigger delay is expressed.

**Parameters:**

<TrigDelUnit>        `SAMPlE | TIME`  
\*RST:            `SAMPlE`

**Example:** `SOURce1:BB:DM:TRIGger:SEQuence RETR`  
`SOURce1:BB:DM:TRIGger:SOURce EXT`  
`SOURce1:BB:DM:TRIGger:DELay:UNIT TIME`  
`SOURce1:BB:DM:TRIGger:EXTernal:TDELay 100`  
`SOURce1:BB:DM:TRIGger:EXTernal:RDELay?`  
`// Response: 100`  
`SOURce1:BB:DM:TRIGger:DELay:UNIT SAMPlE`  
`SOURce1:BB:DM:TRIGger:EXTernal:DELay?`  
`// Response: 27.08`

**Manual operation:** See "[External Delay Unit](#)" on page 293

**[:SOURce<hw>]:BB:DM:TRIGger[:EXTernal<ch>]:DELay <Delay>**

Sets the trigger delay on external triggering.



**Parameters:**

<Delay> float  
 Range: 0 to 65535  
 Increment: 0.01  
 \*RST: 0  
 Default unit: symbol

**Example:**

BB:DM:TRIG:SOUR EXT  
 selects an external trigger  
 BB:DM:TRIG:DEL 50  
 sets a delay of 50 symbols for the trigger.

**Manual operation:** See ["Trigger Delay"](#) on page 293

**[ :SOURce<hw>]:BB:DM:TRIGger[:EXTernal]:TDElay <ExtTimeDelay>**

Specifies the trigger delay for external triggering. The value affects all external trigger signals.

**Parameters:**

<ExtTimeDelay> float  
 Range: 0 to 688  
 Increment: 250E-12  
 \*RST: 0

**Example:**

see [\[ :SOURce<hw>\]:BB:DM:TRIGger:DElay:UNIT](#)  
 on page 568

**Manual operation:** See ["Trigger Delay"](#) on page 293

**[ :SOURce<hw>]:BB:DM:TRIGger[:EXTernal]:RDElay?**

Queries the time (in seconds) an external trigger event is delayed for.

**Return values:**

<ResTimeDelay> float  
 Range: 0 to 688  
 Increment: 250E-12  
 \*RST: 0

**Example:**

see [\[ :SOURce<hw>\]:BB:DM:TRIGger:DElay:UNIT](#)  
 on page 568

**Usage:** Query only

**Manual operation:** See ["Actual Trigger Delay"](#) on page 294

**[ :SOURce<hw>]:BB:DM:TRIGger[:EXTernal<ch>]:INHibit <Inhibit>**

Sets the number of symbols by which a restart is to be inhibited following a trigger event. This command applies only in the case of external triggering.

**Parameters:**

<Inhibit> integer  
 Range: 0 to 67108863  
 \*RST: 0  
 Default unit: symbol

**Example:**

BB:DM:TRIG:SOUR EXT  
 selects an external trigger  
 BB:DM:TRIG:INH 200  
 sets a restart inhibit for 200 symbols following a trigger event.

**Manual operation:** See ["Trigger Inhibit"](#) on page 294

**[:SOURce<hw>]:BB:DM[:TRIGger]:SEQUence <Sequence>**

The command selects the trigger mode.

**Parameters:**

<Sequence> AUTO | RETRigger | AAUTO | ARETrigger | SINGLE

**AUTO**

The modulation signal is generated continuously.

**RETRigger**

The modulation signal is generated continuously. A trigger event (internal or external) causes a restart.

**AAUTO**

The modulation signal is generated only when a trigger event occurs. After the trigger event the signal is generated continuously. Signal generation is stopped with command `SOUR:BB:DM:TRIG:ARM:EXEC` and started again when a trigger event occurs.

**ARETrigger**

The modulation signal is generated only when a trigger event occurs. The device automatically toggles to RETRIG mode. Every subsequent trigger event causes a restart. Signal generation is stopped with command `SOUR:BB:DM:TRIG:ARM:EXEC` and started again when a trigger event occurs.

**SINGLE**

The modulation signal is generated only when a trigger event occurs. After the trigger event the signal is generated once to the set sequence length (`SOUR:BB:DM:TRIG:SLEN`). Every subsequent trigger event caused a restart.

\*RST: AUTO

**Example:**

BB:DM:SEQ AAUT  
 sets the "Armed\_auto" trigger mode; the device waits for the first trigger (e.g. with \*TRG) and then generates the signal continuously.

**Manual operation:** See ["Trigger Mode"](#) on page 291

**Marker Settings**

<code>[:SOURce&lt;hw&gt;]:BB:DM:TRIGger:OUTPut&lt;ch&gt;:MODE</code> .....	571
<code>[:SOURce&lt;hw&gt;]:BB:DM:TRIGger:OUTPut&lt;ch&gt;:OFFTime</code> .....	571
<code>[:SOURce&lt;hw&gt;]:BB:DM:TRIGger:OUTPut&lt;ch&gt;:ONTime</code> .....	572
<code>[:SOURce&lt;hw&gt;]:BB:DM:TRIGger:OUTPut&lt;ch&gt;:PATTern</code> .....	572
<code>[:SOURce&lt;hw&gt;]:BB:DM:TRIGger:OUTPut&lt;ch&gt;:PULSe:DIVider</code> .....	572
<code>[:SOURce&lt;hw&gt;]:BB:DM:TRIGger:OUTPut&lt;ch&gt;:PULSe:FREQuency?</code> .....	573

**`[:SOURce<hw>]:BB:DM:TRIGger:OUTPut<ch>:MODE <Mode>`**

Defines the signal for the selected marker output.

**Parameters:**

<Mode> CLISt | PULSe | PATTern | RATio

**CLISt**

A marker signal that is defined in the selected control list is generated.

**PULSe**

A pulsed marker signal is generated. The pulse frequency (= symbol rate/divider) is defined with the

`SOUR:BB:DM:TRIG:OUTP:PULSe:DIVider` command and can be queried with the

`SOUR:BB:DM:TRIG:OUTP:PULSe:FREQuency?` command.

**PATTern**

A marker signal is generated with the aid of a user-definable bit pattern. The bit pattern is entered with the aid of command

`SOURce:BB:DM:TRIGger:OUTPut:PATTern`. The bit pattern is a maximum of 32 bits long.

**RATio**

A regular marker signal corresponding to the Time Off / Time On specifications in the commands

`SOURce:BB:DM:TRIGger:OUTPut:OFFT` and

`SOURce:BB:DM:TRIGger:OUTPut:ONT` is generated.

\*RST: RATio

**Example:**

`BB:DM:TRIG:OUTP2:MODE PULS`

selects the pulsed marker signal on output MARKER 2.

**Manual operation:** See "[Marker x](#)" on page 294

**`[:SOURce<hw>]:BB:DM:TRIGger:OUTPut<ch>:OFFTime <OffTime>`**

Sets the number of symbols in a period (ON time + OFF time) during which the marker signal in setting `SOURce:BB:DM:TRIGger:OUTPut:MODE RATio` on the marker outputs is OFF.

**Parameters:**

<OffTime> integer  
 Range: 1 to 16777215  
 \*RST: 1  
 Default unit: symbol

**Example:**

BB:DM:TRIG:OUTP2:OFFT 20  
 sets an OFF time of 20 symbols for marker signal 2.  
 In case of two-path instruments, on path A.

**Manual operation:** See "[Marker x](#)" on page 294

**[[:SOURce<hw>]:BB:DM:TRIGger:OUTPut<ch>:ONTime <OnTime>**

Sets the number of symbols in a period (ON time + OFF time) during which the marker signal in setting `SOURce:BB:DM:TRIGger:OUTPut:MODE RATio` on the marker outputs is ON.

**Parameters:**

<OnTime> integer  
 Range: 1 to 16777215  
 \*RST: 1  
 Default unit: symbol

**Example:**

BB:DM:TRIG:OUTP2:ONT 20  
 sets an ON time of 20 symbols for marker 2

**Manual operation:** See "[Marker x](#)" on page 294

**[[:SOURce<hw>]:BB:DM:TRIGger:OUTPut<ch>:PATTern <Pattern>**

Sets the bit pattern used to generate the marker signal in the setting `SOURce:BB:DM:TRIGger:OUTPut:MODE PATTern`. 0 is marker off, 1 is marker on.

**Parameters:**

<Pattern> integer  
 Range: #B0,1 to #B111...1,32  
 \*RST: #B,1

**Example:**

BB:DM:TRIG:OUTP2:PATT #B000000011111111,15  
 sets a bit pattern.  
 BB:DM:TRIG:OUTP2:MODE PATT  
 activates the marker signal according to a bit pattern on output MARKER 2.

**Manual operation:** See "[Marker x](#)" on page 294

**[[:SOURce<hw>]:BB:DM:TRIGger:OUTPut<ch>:PULSe:DIVider <Divider>**

Sets the divider for Pulse marker mode (`SOUR:BB:DM:TRIGr:OUTP:MODE PULSe`). The resulting pulse frequency is derived by dividing the symbol rate by the divider.

**Parameters:**

<Divider> integer  
 Range: 2 to 1024  
 \*RST: 2

**Example:**

BB:DM:TRIG:OUTP2:PULS:DIV 2  
 sets the divider to 2 for the marker signal on output MARKER 2.  
 BB:DM:TRIG:OUTP2:FREQ?  
 queries the resulting pulse frequency of the marker signal.  
 Response: 66 000  
 the resulting pulse frequency is 66 kHz.

**Manual operation:** See "Marker x" on page 294

**[[:SOURce<hw>]:BB:DM:TRIGger:OUTPut<ch>:PULSe:FREQuency?**

Queries the pulse frequency of the pulsed marker signal in the setting  
 SOURce:BB:DM:TRIGger:OUTPut:MODE PULSe. The pulse frequency is derived by  
 dividing the symbol rate by the divider.

**Return values:**

<Frequency> float

**Example:**

BB:DM:TRIG:OUTP2:PULS:DIV 2  
 sets the divider marker signal on output MARKER 2 to the value  
 2.  
 BB:DM:TRIG:OUTP2:MODE PULS  
 enables the pulsed marker signal.  
 BB:DM:TRIG:OUTP2:PULS:FREQ?  
 queries the pulse frequency of the marker signal.  
 Response: 33 000  
 the resulting pulse frequency is

**Usage:** Query only

**Filter Settings**

[[:SOURce<hw>]:BB:DM:FILTer:OSAMpling.....	574
[[:SOURce<hw>]:BB:DM:FILTer:OSAMpling:AUTO.....	574
[[:SOURce<hw>]:BB:DM:FILTer:PARAmeter:COSSine[;ROLLoff].....	574
[[:SOURce<hw>]:BB:DM:FILTer:PARAmeter:GAUSS.....	574
[[:SOURce<hw>]:BB:DM:FILTer:PARAmeter:LPASS.....	574
[[:SOURce<hw>]:BB:DM:FILTer:PARAmeter:LPASSEVM.....	574
[[:SOURce<hw>]:BB:DM:FILTer:PARAmeter:PGAUSS.....	574
[[:SOURce<hw>]:BB:DM:FILTer:PARAmeter:RCOSSine.....	574
[[:SOURce<hw>]:BB:DM:FILTer:PARAmeter:SPHase.....	574
[[:SOURce<hw>]:BB:DM:FILTer:PARAmeter:APCO25.....	574
[[:SOURce<hw>]:BB:DM:FILTer:PARAmeter:COSSine:BANDwidth.....	575
[[:SOURce<hw>]:BB:DM:FILTer:PARAmeter:APCO25Lsm:GAUSS.....	576
[[:SOURce<hw>]:BB:DM:FILTer:PARAmeter:APCO25Lsm:LOWPass.....	576
[[:SOURce<hw>]:BB:DM:FILTer:TYPE.....	576
[[:SOURce<hw>]:DM:FILTer:PARAmeter.....	576

---

```
[[:SOURce<hw>]:BB:DM:FILTer:OSAMpling <OSampling>
```

The command sets the upsampling factor.

**Parameters:**

```
<OSampling>      integer
                  Range:    1 to 32
                  *RST:    32
```

**Example:** `BB:DM:FILT:OSAM 32`  
sets the upsampling factor to 32.

**Manual operation:** See "Oversampling" on page 278

---

```
[[:SOURce<hw>]:BB:DM:FILTer:OSAMpling:AUTO <Auto>
```

The command activates/deactivates the upsampling factor state. If activated, the most sensible parameter values are selected. The value depends on the coherence check. If deactivated, the values can be changed manually.

**Parameters:**

```
<Auto>           0 | 1 | OFF | ON
                  *RST:    1
```

**Example:** `BB:DM:FILT:OSAM:AUTO ON`  
The most sensible parameters are selected automatically.

**Manual operation:** See "Oversampling" on page 278

---

```
[[:SOURce<hw>]:BB:DM:FILTer:PARAMeter:COsine[:ROLLoff] <Cosine>
```

```
[[:SOURce<hw>]:BB:DM:FILTer:PARAMeter:GAUSS <Gauss>
```

```
[[:SOURce<hw>]:BB:DM:FILTer:PARAMeter:LPASS <LPass>
```

```
[[:SOURce<hw>]:BB:DM:FILTer:PARAMeter:LPASSEVM <LPassEvm>
```

```
[[:SOURce<hw>]:BB:DM:FILTer:PARAMeter:PGAUSS <PGauss>
```

```
[[:SOURce<hw>]:BB:DM:FILTer:PARAMeter:RCOSine <RCosine>
```

```
[[:SOURce<hw>]:BB:DM:FILTer:PARAMeter:SPHase <SPHase>
```

```
[[:SOURce<hw>]:BB:DM:FILTer:PARAMeter:APCO25 <Apco25>
```

The command sets the roll-off factor for filter type APCO25.

On selecting filter APCO25, the filter parameter is set to the default value.

**Parameters:**

```
<Apco25>         float
                  Range:    0.05 to 0.99
                  Increment: 0.01
                  *RST:    0.2
```

```
<Cosine>         float
                  Range:    0.05 to 1.00
                  Increment: 0.01
                  *RST:    0.35
```

<Gauss>	float
	Range: 0.15 to 100000
	Increment: 0.01
	*RST: 0.3
<LPass>	float
	Range: 0.05 to 2
	Increment: 0.01
	*RST: 0.5
<LPassEvm>	float
	Range: 0.05 to 2
	Increment: 0.01
	*RST: 0.5
<PGauss>	float
	Range: 0.15 to 2.5
	Increment: 0.01
	*RST: 0.3
<RCosine>	float
	Range: 0.05 to 1.00
	Increment: 0.01
	*RST: 0.35
<SPhase>	float
	Range: 0.15 to 2.5
	Increment: 0.01
	*RST: 2

**Example:** `BB:DM:FILT:PAR:APCO25 0.2`  
sets the roll-off factor to 0.2 for filter type APCO25.

**Manual operation:** See "[Filter Parameter](#)" on page 278

**[[:SOURce<hw>]:BB:DM:FILT:PAR:PARAMeter:COsine:BA NDwidth <FiltParm>**

Sets the bandwidth of the cosine filter.

**Parameters:**

<FiltParm>	float
	Range: 400 to 25E6
	Increment: 1E-3
	*RST: 270833.333

**Example:** `:BB:DM:FILT:TYPE COS`  
`:BB:DM:FILT:PAR:COS:BA ND 7200`

**Manual operation:** See "[Bandwidth](#)" on page 278

---

```
[:SOURce<hw>]:BB:DM:FILTer:PARAmeter:APCO25Lsm:GAUSs <FiltParm>
[:SOURce<hw>]:BB:DM:FILTer:PARAmeter:APCO25Lsm:LOWPass <FiltParm>
```

Sets the cut off frequency for the lowpass/ gauss filter.

**Parameters:**

```
<FiltParm>          float
                    Range:    400 to 25E6
                    Increment: 1E-3
                    *RST:     270833.333
```

**Example:**

```
:BB:DM:FILT:TYPE APCO25Lsm
:BB:DM:FILT:PAR:APCO25L:LOWP 5166.667
:BB:DM:FILT:PAR:APCO25L:GAUS 1700
```

**Manual operation:** See ["Cut Off Frequency Factor"](#) on page 278

---

```
[:SOURce<hw>]:BB:DM:FILTer:TYPE <Type>
```

The command selects the filter type.

When a standard is selected (:BB:DM:STAN), the filter type and filter parameter are set to the default value.

**Parameters:**

```
<Type>              RCOSine | COSine | GAUSs | LGAuss | CONE | COF705 |
                    COEQualizer | COFequalizer | C2K3x | APCO25 | SPHase |
                    RECTangle | USER | PGAuss | LPASs | DIRac | ENPShape |
                    EWPSshape | LTEFilter | LPASSEVM | APCO25Hcpm |
                    APCO25Lsm
                    *RST:    GAUSs
```

**Example:**

```
BB:DM:FILT:TYPE COS
selects the Cosine filter type.
```

**Manual operation:** See ["Filter"](#) on page 278

---

```
[:SOURce<hw>]:DM:FILTer:PARAmeter <Parameter>
```

Sets the filter parameter of the currently selected filter type.

To set the filter type, use command `[ :SOURce<hw> ] :BB:DM:FILTer:TYPE` on page 576.

**Parameters:**

```
<Parameter>        float
                    Range:    0.05 to 2.5
                    Increment: 0.01
                    *RST:     0.35
```

**Example:**

```
BB:DM:FILT:TYPE COS
DM:FILT:PAR 0.5
sets 0.5 roll-off factor for the cosine filter.
```



**Modulation Settings**

<code>[ :SOURce&lt;hw&gt;]:BB:DM:AQPSk:ANGLE</code> .....	577
<code>[ :SOURce&lt;hw&gt;]:BB:DM:ASK:DEPTH</code> .....	577
<code>[ :SOURce&lt;hw&gt;]:BB:DM:CODing</code> .....	577
<code>[ :SOURce&lt;hw&gt;]:BB:DM:FORMat</code> .....	578
<code>[ :SOURce&lt;hw&gt;]:BB:DM:FSK:DEVIation</code> .....	578
<code>[ :SOURce&lt;hw&gt;]:BB:DM:FSK:VARiable:SYMBOL&lt;ch0&gt;:DEVIation</code> .....	579
<code>[ :SOURce&lt;hw&gt;]:BB:DM:FSK:VARiable:TYPE</code> .....	579
<code>[ :SOURce&lt;hw&gt;]:BB:DM:MDELay?</code> .....	580

**[ :SOURce<hw>]:BB:DM:AQPSk:ANGLE <Angle>**

For AQPSK modulation, sets the angle alpha between the point (0,0) and the I axis.

**Parameters:**

<Angle>	float
	Range: 0 to 180
	Increment: 0.01
	*RST: 0
	Default unit: Deg

**Example:**

```
BB:DM:FORM AQPS
selects modulation type AQPSK.
BB:DM:AQPS:ANGL 45
```

**Manual operation:** See "[Angle Alpha](#)" on page 275

**[ :SOURce<hw>]:BB:DM:ASK:DEPTH <Depth>**

The command sets the ASK modulation depth when modulation type ASK is selected.

**Parameters:**

<Depth>	float
	Range: 0 to 100
	Increment: 0.1
	*RST: 100
	Default unit: PCT

**Example:**

```
BB:DM:FORM ASK
selects the ASK modulation type.
BB:DM:ASK:DEPT 50 PCT
sets a modulation depth of 50 percent.
```

**Manual operation:** See "[ASK Depth](#)" on page 275

**[ :SOURce<hw>]:BB:DM:CODing <Coding>**

The command selects the modulation coding.

If the modulation type selected (`:BB:DM:FORM`) is not possible with the coding that has been set, it is automatically set to OFF (`:BB:DM:COD OFF`).

When a standard is selected (:BB:DM:STAN), the coding is set to the default value.

**Parameters:**

<Coding> OFF | DIFF | DPHS | DGRay | GRAY | GSM | NADC | PDC | PHS | TETRa | APCO25 | PWT | TFTS | INMarsat | VDL | EDGE | APCO25FSK | ICO | CDMA2000 | WCDMA | APCO258PSK

**DPHS**

Phase Difference

**DGRay**

Difference + Gray

\*RST: INTernal

**Example:**

BB:DM:COD GRAY

selects GRAY coding. This coding is valid for all modulation types.

**Manual operation:** See "[Coding](#)" on page 274

**[[:SOURce<hw>]:BB:DM:FORMat <Format>**

Selects the modulation type.

If the coding that is set (:BB:DM:COD) is not possible with the modulation type selected, it is automatically set to OFF (:BB:DM:COD OFF).

When a standard is selected (:DM:STAN), the modulation type is set to the default value.

**Parameters:**

<Format> ASK | BPSK | P2DBpsk | QPSK | QPSK45 | OQPSk | P4QPsk | P4DQpsk | PSK8 | P8D8psk | P8EDge | QAM16 | QAM32 | QAM64 | QAM256 | QAM1024 | MSK | FSK2 | FSK4 | USER | FSKVar | QAM128 | QEDGe | QAM16EDge | QAM32EDge | AQPSk | QAM4096

\*RST: MSK

**Example:**

BB:DM:FORM QPSK

selects modulation type QPSK.

**Manual operation:** See "[Modulation Type](#)" on page 275

**[[:SOURce<hw>]:BB:DM:FSK:DEViation <Deviation>**

Sets the frequency deviation when FSK modulation is selected. The range of values depends on the symbol rate that is set (see data sheet) and the maximum deviation is 10 MHz.

If the symbol rate that is set exceeds the maximum possible value for the chosen frequency deviation, it is suitably adapted (:BB:DM:SRAT).

**Parameters:**

<Deviation> float  
 Range: 1 to 40E6  
 Increment: 0.5  
 \*RST: 135416.5

**Example:**

BB:DM:FORM FSK  
 selects FSK modulation.  
 BB:DM:FSK:DEV 10 MHz  
 sets the frequency deviation to 10 MHz.

**Manual operation:** See "[FSK Deviation](#)" on page 275

**[[:SOURce<hw>]:BB:DM:FSK:VARiable:SYMBOL<ch0>:DEViation <Deviation>**

The command sets the deviation of the selected symbol for variable FSK modulation mode.

**Suffix:**

<ch> 0 .. 16  
 The number of symbols (and therefore the suffix range) depends on the selected FSK modulation type.

**Parameters:**

<Deviation> float  
 The range of values depends on the symbol rate that is set (see data sheet) and the maximum deviation is 10 MHz.  
 Range: -40E6 to 40E6  
 Increment: 0.5  
 Default unit: Hz

**Example:**

BB:DM:FORM FSKV  
 selects Variable FSK modulation.  
 BB:DM:FSK:VAR:TYPE FSK16  
 selects 16FSK modulation.  
 BB:DM:FSK:VAR:SYMBOL:DEV 135000  
 sets the frequency deviation of the least significant symbol to 135 kHz.

**Manual operation:** See "[Deviation xxxx](#)" on page 277

**[[:SOURce<hw>]:BB:DM:FSK:VARiable:TYPE <Type>**

The command selects the modulation type for Variable FSK.

**Parameters:**

<Type> FSK4 | FSK8 | FSK16  
 \*RST: FSK4

**Example:** BB:DM:FORM FSKV  
selects Variable FSK modulation.  
BB:DM:FSK:VAR:TYPE FSK16  
selects 16FSK modulation.

**Manual operation:** See "FSK Type" on page 277

### **[:SOURce<hw>]:BB:DM:MDELay?**

The command queries the digital modulation delay from the data input to the I/Q output in the case of external modulation.

**Return values:**

<MDelay> float  
Range: 0 to 1  
Increment: 1E-6  
\*RST: 0

**Example:** BB:DM:MDEL?  
queries the delay in the case of external modulation.  
Response: 0.4 ms  
the delay is 0.4 ms.

**Usage:** Query only

**Manual operation:** See "Modulation Delay" on page 277

### **Power Ramp**

<a href="#">[:SOURce&lt;hw&gt;]:BB:DM:PRAMP:ATTenuation</a> .....	580
<a href="#">[:SOURce&lt;hw&gt;]:BB:DM:PRAMP:FDELay</a> .....	581
<a href="#">[:SOURce&lt;hw&gt;]:BB:DM:PRAMP:RDELay</a> .....	581
<a href="#">[:SOURce&lt;hw&gt;]:BB:DM:PRAMP:SHAPE</a> .....	581
<a href="#">[:SOURce&lt;hw&gt;]:BB:DM:PRAMP:SOURce</a> .....	581
<a href="#">[:SOURce&lt;hw&gt;]:BB:DM:PRAMP:TIME</a> .....	582
<a href="#">[:SOURce&lt;hw&gt;]:BB:DM:PRAMP[:STATE]</a> .....	582

### **[:SOURce<hw>]:BB:DM:PRAMP:ATTenuation <Attenuation>**

Sets the level attenuation for signal ranges that are flagged with level attribute attenuated by the LEV\_ATT control signal.

**Parameters:**

<Attenuation> float  
Range: 0 to 50  
Increment: 0.1  
\*RST: 15  
Default unit: dB

**Example:** BB:DM:PRAMP:ATT 15 dB  
sets a level attenuation of 15 dB.

**Manual operation:** See "Attenuation" on page 289

**[:SOURce<hw>]:BB:DM:PRAMP:FDELay <FDelay>**

Sets the delay in the falling edge. A positive value gives rise to a delay and a negative value causes an advance.

**Parameters:**

<FDelay> float  
 Range: 0 to 4  
 Increment: 0.01  
 \*RST: 0  
 Default unit: symbol

**Example:**

BB:DM:PRAMP:FDEL 1  
 The falling edge starts 1 symbol later.

**Manual operation:** See ["Fall Delay"](#) on page 289

**[:SOURce<hw>]:BB:DM:PRAMP:RDELay <RDelay>**

Sets the delay in the rising edge. A positive value gives rise to a delay and a negative value causes an advance.

**Parameters:**

<RDelay> float  
 Range: 0 to 4  
 Increment: 0.01  
 \*RST: 0  
 Default unit: symbol

**Example:**

BB:DM:PRAMP:RDEL 1  
 The rising edge starts 1 symbol later.

**Manual operation:** See ["Rise Delay"](#) on page 289

**[:SOURce<hw>]:BB:DM:PRAMP:SHAPE <Shape>**

The command sets the edge shape of the ramp envelope.

**Parameters:**

<Shape> LINear | COSine  
 \*RST: COSine

**Example:**

BB:DM:PRAMP:SHAP COS  
 selects a cosine-shaped rise and fall for the transmitted power edge.

**Manual operation:** See ["Ramp Function"](#) on page 288

**[:SOURce<hw>]:BB:DM:PRAMP:SOURce <Source>**

Sets the source for the power ramp control signals.

**Parameters:**

<Source> INTernal | EXTernal

**INTernal**

The internal control signals LEV\_ATT and BURST are used. Control signals are stored in dedicated lists. When remote control is in use, the list to be used is defined, selected and enabled with the aid of `SOURce:BB:DM:CLISt:...` commands.

**EXTernal**

The digital control signals LEV\_ATT and BURST are supplied via the control signal inputs on the AUX I/O connector.

\*RST: INTernal

**Example:**

`BB:DM:PRAM:SOUR INT`

enables the use of internal control signals for power ramp control.

**Manual operation:** See "[Source](#)" on page 288

**[:SOURce<hw>]:BB:DM:PRAMP:TIME <Time>**

Sets the power ramping rise time and fall time for a burst.

**Parameters:**

<Time> float  
 Range: 0.25 to 16  
 Increment: 0.01  
 \*RST: 1  
 Default unit: symbol

**Example:**

`BB:DM:PRAM:TIME 2`

sets a time of 2 symbols for the edges to rise and fall.

**Manual operation:** See "[Ramp Time](#)" on page 289

**[:SOURce<hw>]:BB:DM:PRAMP[:STATE] <State>**

The command enables or disables power ramping.

**Parameters:**

<State> 0 | 1 | OFF | ON  
 \*RST: 0

**Example:**

`BB:DM:PRAM:STAT ON`

switches power ramping on.

**Manual operation:** See "[State](#)" on page 288

**DM Lists**

The following section brings together the commands for defining and managing the data lists and control lists for digital modulation.

Lists are stored as files with specific file extensions in a user-definable directory (see [Table 7-2](#)). To specify the default directory, use the command `:MMEMory:CDIRectory`. To access files in this directory, enter their file name; the path and extension are optional.

**Table 7-2: Overview of the used list types**

List type	Content	File extension
Data List	Digital modulation data	*.dm_iqd
Control List	Digital modulation control data	*.dm_iqc
User Standards	User settings of digital modulation	*.dm_stu
Usr Filter	Usr filter settings	*.vaf
User Mapping	User mapping settings	*.vam

It is not possible to use other file extensions with the commands. Attempting to do so will cause an error message. If the file extension is changed in any other way (e.g. by directly accessing the file system) the lists are no longer recognized and therefore invalid.



The `CLIST` commands always create a binary control list, even if ASCII format is specified.

Therefore, to create a \*.wv file with R&S WinIQSIM2 using a control list, use the input control list in ASCII format. Refer to the example in [Chapter 7.4.4, "Creating an ASCII C-List Manually"](#), on page 451 for more information.

### List of Commands

<code>[:SOURce&lt;hw&gt;]:BB:DM:CLISt:CATalog?</code> .....	584
<code>[:SOURce&lt;hw&gt;]:BB:DM:DLISt:CATalog?</code> .....	584
<code>[:SOURce&lt;hw&gt;]:BB:DM:FLISt:CATalog?</code> .....	584
<code>[:SOURce&lt;hw&gt;]:BB:DM:MLISt:CATalog?</code> .....	584
<code>[:SOURce&lt;hw&gt;]:BB:DM:CLISt:FREE?</code> .....	584
<code>[:SOURce&lt;hw&gt;]:BB:DM:DLISt:FREE?</code> .....	584
<code>[:SOURce&lt;hw&gt;]:BB:DM:FLISt:FREE?</code> .....	584
<code>[:SOURce&lt;hw&gt;]:BB:DM:MLISt:FREE?</code> .....	584
<code>[:SOURce&lt;hw&gt;]:BB:DM:CLISt:COpy</code> .....	585
<code>[:SOURce&lt;hw&gt;]:BB:DM:DLISt:COpy</code> .....	585
<code>[:SOURce&lt;hw&gt;]:BB:DM:CLISt:TAg?</code> .....	585
<code>[:SOURce&lt;hw&gt;]:BB:DM:DLISt:TAg?</code> .....	585
<code>[:SOURce&lt;hw&gt;]:BB:DM:CLISt:DAtA</code> .....	586
<code>[:SOURce&lt;hw&gt;]:BB:DM:CLISt:DELeTe</code> .....	587
<code>[:SOURce&lt;hw&gt;]:BB:DM:CLISt:POINts?</code> .....	587
<code>[:SOURce&lt;hw&gt;]:BB:DM:CLISt:SELeCt</code> .....	587
<code>[:SOURce&lt;hw&gt;]:BB:DM:DLISt:DAtA</code> .....	588
<code>[:SOURce&lt;hw&gt;]:BB:DM:DLISt:DAtA:APPend</code> .....	589
<code>[:SOURce&lt;hw&gt;]:BB:DM:DLISt:DELeTe</code> .....	589
<code>[:SOURce&lt;hw&gt;]:BB:DM:DLISt:POINts</code> .....	589
<code>[:SOURce&lt;hw&gt;]:BB:DM:DLISt:SELeCt</code> .....	590

<code>[SOURce&lt;hw&gt;]:BB:DM:FLISt:DELeTe</code> .....	590
<code>[SOURce&lt;hw&gt;]:BB:DM:FLISt:POINts?</code> .....	591
<code>[SOURce&lt;hw&gt;]:BB:DM:FLISt:SELeCt</code> .....	591
<code>[SOURce&lt;hw&gt;]:BB:DM:MLISt:DELeTe</code> .....	591
<code>[SOURce&lt;hw&gt;]:BB:DM:MLISt:POINts?</code> .....	592
<code>[SOURce&lt;hw&gt;]:BB:DM:MLISt:SELeCt</code> .....	592
<code>[SOURce&lt;hw&gt;]:BB:DM:SETTing:CATalog?</code> .....	592
<code>[SOURce&lt;hw&gt;]:BB:DM:SETTing:DELeTe</code> .....	593
<code>[SOURce&lt;hw&gt;]:BB:DM:SETTing:LOAD</code> .....	593
<code>[SOURce&lt;hw&gt;]:BB:DM:SETTing:STORe</code> .....	593
<code>[SOURce&lt;hw&gt;]:BB:DM:SETTing:STORe:FAST</code> .....	594
<code>[SOURce&lt;hw&gt;]:BB:DM:STANdard:ULISt:CATalog?</code> .....	594
<code>[SOURce&lt;hw&gt;]:BB:DM:STANdard:ULISt:DELeTe</code> .....	594
<code>[SOURce&lt;hw&gt;]:BB:DM:STANdard:ULISt:LOAD</code> .....	595
<code>[SOURce&lt;hw&gt;]:BB:DM:STANdard:ULISt:STORe</code> .....	595

---

`[SOURce<hw>]:BB:DM:CLISt:CATalog?`  
`[SOURce<hw>]:BB:DM:DLISt:CATalog?`  
`[SOURce<hw>]:BB:DM:FLISt:CATalog?`  
`[SOURce<hw>]:BB:DM:MLISt:CATalog?`

Queries the user mapping lists present in the default directory. The default directory is set using command `M MEM:CDIRectory`. When the names of the files are returned they are separated by commas.

The command only reads out files with the `*.vam` extension (see also [Table 7-2](#)).

**Return values:**

<Catalog>                    string

**Example:**

```
BB:DM:FORM USER
selects the User modulation type.
M MEM:CDIR 'D:\user\mapping_List'
sets the default directory for the user mapping lists.
BB:DM:MLIS:CAT?
queries the user mapping lists in the directory.
```

**Usage:**                    Query only

**Manual operation:**    See "[Load User Mapping](#)" on page 275

---

`[SOURce<hw>]:BB:DM:CLISt:FREE?`  
`[SOURce<hw>]:BB:DM:DLISt:FREE?`  
`[SOURce<hw>]:BB:DM:FLISt:FREE?`  
`[SOURce<hw>]:BB:DM:MLISt:FREE?`

Queries the user modulation mapping list free memory.

**Return values:**

<Free>                    integer  
                              Range:        0 to INT\_MAX  
                              \*RST:        0



**Example:** BB:DM:FORM USER  
selects the User modulation type.  
BB:DM:FLIS:FREE?  
queries the free memory.

**Usage:** Query only

**[:SOURce<hw>]:BB:DM:CLIST:COPY <Filename>**

**[:SOURce<hw>]:BB:DM:DLIST:COPY <Filename>**

The command copies the selected data list into the data list specified by <list name>. If a data list with the specified name already exists, it is overwritten. If it does not yet exist, it is created.

The source file has to be available in the default directory. The default directory is set using command `MMEM:CDIRECTORY`. A path can be specified, in which case the source file is copied into the file <list name> in the specified directory. The file extension may be omitted.

Only files with the file extension `*.dm_iqc` will be copied (see also [Table 7-2](#)).

**Setting parameters:**

<Filename> string

**Example:** BB:DM:DLIS 'd\_list1'  
selects data list d\_list1.  
BB:DM:DLIS:COPY 'd\_list2'  
copies the content of data list d\_list1 into data list d\_list2.  
Any existing content in data list d\_list2 is overwritten.

**Usage:** Setting only

**Manual operation:** See "[File Manager](#)" on page 281

**[:SOURce<hw>]:BB:DM:CLIST:TAG?**

**[:SOURce<hw>]:BB:DM:DLIST:TAG?**

The command queries the content of the specified tag in the selected file.

**Return values:**

<Tag> <control list>,<tag name>

**Example:** BB:DM:DLIS:TAG 'D\_list1','date'  
queries the Date tag in control list D\_list1.  
Response:10.10.2008  
the data list was created on 10.10.2008.

**Usage:** Query only

**[ :SOURce<hw> ] :BB:DM:CLIS:DATA <Data>**

The command sends the data to the currently selected control list. If the list already contains data, it is overwritten. This command only writes data into the data section of the file.

The values for the control signals are sent, arranged in a 8-bit value as follows:

Signal	Order	Decimal value of bits
Marker 1	LSBit	1
Marker 2		2
Marker 3		4
Marker 4		8
Burst =	LSBit	16
LevAtt1	LSBit	32
CWMod	LSBit	64
Hop	MSBit	128

The data can also be sent as a binary block, each binary block being a 2-byte value in which the 16 bits represent the binary values (16-bit unsigned integer, 2 bytes, LSByte first). When binary data transmission is in use, command `:SYSTEM:COMMunicate:GPIB:LTERminator EOI` should be used to set the termination character mode to 'EOI control data message only' so that a random LF in the data sequence is not interpreted as End, thereby prematurely terminating the data transmission. The command `...LTER STANdard` resets the mode.

For query purposes, the command `:FORMat ASCii | PACKed` can be used to switch between the formats. The byte sequence is defined in the IEC bus standard as 'most significant byte first'

**Note:** C-Lists are created in binary format. However, if you need the C-List in ASCII format, e.g. for creating a waveform file with R&S WinIQSIM2, see the example in [Chapter 7.4.4, "Creating an ASCII C-List Manually"](#), on page 451.

\*RST has no effect on data lists. This command is without query.

**Setting parameters:**

<Data> string

**Example:**

```
BB:DM:CLIS:SEL 'c_list1'
```

selects the control list.

```
BB:DM:CLIS:DATA 0,0,0,0,8,8,8,0,0,0,0...
```

enters the control values in list c\_list1. In the example, only ramps for marker 4 are set.

**Usage:** Setting only

**Manual operation:** See ["Edit Control List"](#) on page 285

**[:SOURce<hw>]:BB:DM:CLIS:DELeT** <Filename>

The command deletes the specified control list from the default directory. The default directory is set using command `MMEM:CDIRectory`. A path can also be specified, in which case the files in the specified directory are deleted. The file extension may be omitted. Only files with the file extension `*.dm_iqc` will be deleted.

**Setting parameters:**

<Filename>                    <list name>

**Example:**                    `BB:DM:CLIS:DEL 'c_list3'`  
deletes control list `c_list3`.

**Usage:**                      Setting only

**Manual operation:**    See ["File Manager"](#) on page 281

**[:SOURce<hw>]:BB:DM:CLIS:POINtS?**

The command queries the number of lines (2 bytes) in the currently selected list.

**Return values:**

<Points>                      integer  
Range:                        0 to INT\_MAX  
\*RST:                         0

**Example:**                    `BB:DM:CLIS:SEL "c_list1"`  
selects control list `c_list1`.  
`BB:DM:CLIS:POIN?`  
queries the number of lines in the control list.  
Response: 20  
the control list consists of 20 lines.

**Usage:**                      Query only

**[:SOURce<hw>]:BB:DM:CLIS:SELeCt** <Filename>

The command selects the control list in the default directory. The default directory is set using command `MMEM:CDIRectory`. A path can also be specified, in which case the files in the specified directory are selected. If a control list with the specified name does not yet exist, it is created. The file extension may be omitted. Only files with the file extension `*.dm_iqc` will be selected or created.

**Parameters:**

<Filename>                    <list name>

**Example:**                    `BB:DM:CLIS:SEL 'c_list1'`  
selects control list `c_list1`.

**Manual operation:**    See ["Functions for handling of control lists"](#) on page 173

```
[ :SOURce<hw>]:BB:DM:DLIS:DATA <Data>
[:SOURce<hw>]:BB:DM:DLIS:DATA? [<Start>[, <Count>]]
```

The **Setting** command sends the bit data to the data list selected with the aid of `:BB:DM:DLIS:SElect`. Any existing content in the data list is overwritten. This command only writes data into the data section of the file.

This command sends the bit data to the selected data list, which is overwritten. The data can also be sent as block data in binary or PACKed format, each byte being interpreted as 8 data bits. In this case, command `:SYSTEM:COMMunicate:GPIB:LTERminator EOI` should be used to set the termination character mode to 'EOI control data message only' so that a random LF in the data sequence is not interpreted as End, thereby prematurely terminating the data transmission. The command `...LTERSTAN` resets the mode.

The **query** reads out the data part of the data list. If the query is expanded by using the two parameters `<start>` and `<length>`, the list is read out in smaller sections. Start and Length are expressed in bits. Without the parameters the total length is always read out starting from address 1. The command `:FORMat ASCii | PACKed` can be used to select the data format. The byte sequence is defined in the IEC bus standard (read/write most significant byte first). `*RST` has no effect on data lists.

**Parameters:**

`<Data>` integer

**Query parameters:**

`<Start>` integer  
Range: 1 to 2147483647

`<Count>` integer  
Range: 1 to 2147483647

**Example:** `BB:DM:DLIS:SEL 'dlist1'`  
selects data list dlist1. If the file does not yet exist, it is created.  
`BB:DM:DLIS:DATA 1,1,1,0,0,0,1,1,0,1...`  
sends the specified data to file dlist1. Any data already present is overwritten.

**Example:** `BB:DM:DLIS:SEL 'dlist1'`  
selects data list dlist1.  
`FORM ASCI`  
selects ASCII data transmission format.  
`BB:DM:DLIS:DATA? 2048,1024`  
queries the data starting at bit 2048 for 1024 bits.

**Manual operation:** See "[Data List Editor](#)" on page 282

**[ :SOURce<hw>]:BB:DM:DLIS:DATA:APPend <Bits>**

The command appends the bit data onto the end of the existing data in the selected data list. This means that existing content in the data list is not overwritten. By this means very long data lists can be built up piecemeal. The data format is as specified in command `SOURce:BB:DM:DLIS:DATA`.

The command cannot be used with an empty data list, such as one that has just been created, for example. In this case the command `SOURce:BB:DM:DLIS:DATA` must first be used to enter modulation data in the list.

\*RST has no effect on data lists.

**Setting parameters:**

<Bits> 0 | 1 {,0 | 1 } | block data

**Example:**

```
BB:DM:DLIS:SEL ' d_list2'
selects data list d_list2.
FORM ASC
selects ASCII data transmission format.
BB:DM:DLIS:DATA:APP 1,1,1,0,0,0,1,1,0,1...
adds the specified numeric data to the existing data in data list
d_list2.
```

**Usage:** Setting only

**Manual operation:** See "[Data List Editor](#)" on page 282

**[ :SOURce<hw>]:BB:DM:DLIS:DELeTe <Filename>**

The command deletes the specified data list. from the default directory. The default directory is set using command `MMEM:CDIRectory`. A path can also be specified, in which case the files in the specified directory are deleted. The file extension may be omitted. Only files with the file extension `*.dm_iqd` will be deleted.

The numeric suffix on `SOURce<[1] | 2>` is ignored in this command.

**Setting parameters:**

<Filename> string

**Example:**

```
BB:DM:DLIS:DEL ' d_list2'
deletes data list d_list2.
```

**Usage:** Setting only

**Manual operation:** See "[File Manager](#)" on page 281

**[ :SOURce<hw>]:BB:DM:DLIS:POINts <Points>**

The command defines the number of bits in the selected data list to be utilized. When a list is being filled with block data, this data is only ever sent in multiples of 8 bits. However the exact number of bits to be exploited can be set to a different figure. The superfluous bits in the list are then ignored.

**Parameters:**

<Points> integer  
 Range: 0 to INT\_MAX  
 \*RST: 0

**Example:**

BB:DM:DLIS:POIN 234  
 defines the number of bits in the data list to be utilized as 234 bits. If the list was filled with block data, at least the last 6 bits will be ignored.

**[[:SOURce<hw>]:BB:DM:DLIS:SElect <Select>**

The command selects the data list in the default directory. The default directory is set using command `MMEM:CDIRectory`. A path can also be specified, in which case the files in the specified directory are selected. If a data list with the specified name does not yet exist, it is created. The file extension may be omitted. Only files with the file extension `*.dm_iqd` will be selected or created.

The modulation data in this data list is used when the data source is selected using the command `SOURce:BB:DM:SOURce DLIS`.

**Parameters:**

<Select> <list name>

**Example:**

BB:DM:DLIS:SEL 'd\_list2'  
 selects data list `d_list2`.

**Manual operation:** See ["Functions for handling of data lists"](#) on page 173

**[[:SOURce<hw>]:BB:DM:FLIS:DElete <Filename>**

Deletes the specified user filter file. The default directory is set using command `MMEM:CDIRectory`. A path can also be specified, in which case the files in the specified directory are read. The file extension may be omitted. Only files with the file extension `*.vaf*.vaf` will be deleted.

**Setting parameters:**

<Filename> string

**Example:**

BB:DM:FILT:TYPE USER  
 selects the User filter type.  
 MMEM:CDIR 'D:\user\Filter\_List'  
 sets the default directory for the user-defined filters.  
 BB:DM:FLIS:DEL user\_filter3  
 deletes the user-defined filter.

**Usage:** Setting only

**Manual operation:** See ["Load User Filter"](#) on page 279

**[[:SOURce<hw>]:BB:DM:FLIS:POINts?**

Queries the user filter list length.

**Return values:**

<Points> integer  
 Range: 0 to INT\_MAX  
 \*RST: 0

**Example:** BB:DM:FILT:TYPE USER  
 selects the User filter type.  
 BB:DM:FLIS:POIN?  
 queries the list length.

**Usage:** Query only

**[[:SOURce<hw>]:BB:DM:FLIS:SELEct <Filename>**

Selects the user-defined filter (\* .vaf).

The directory applicable to the following command is defined with the command `MMEM:CDIRECTory`. To access the files in this directory, only the file name is required, without the path and the file extension.

**Parameters:**

<Filename> string

**Example:** BB:DM:FILT:TYPE USER  
 selects the User filter type.  
 MMEM:CDIR 'D:\user\Filter\_List'  
 sets the default directory for the user-defined filters.  
 BB:DM:FLIS:SEL user\_filter3  
 selects the user-defined filter.

**Manual operation:** See "[Load User Filter](#)" on page 279

**[[:SOURce<hw>]:BB:DM:MLIS:DELEte <Filename>**

Deletes the specified user mapping file. The default directory is set using command `MMEM:CDIRECTory`. A path can also be specified, in which case the files in the specified directory are read. The file extension may be omitted. Only files with the file extension \* .vam will be deleted.

**Setting parameters:**

<Filename> string

**Example:** BB:DM:FORM USER  
 selects the User modulation type.  
 MMEM:CDIR 'D:\user\mapping\_List'  
 sets the default directory for the user mapping lists.  
 BB:DM:MLIS:DEL user\_mapping3  
 deletes the user mapping list.

**Usage:** Setting only

**Manual operation:** See ["Load User Mapping"](#) on page 275

---

### **[[:SOURce<hw>]:BB:DM:MLIS:POINTs?**

Queries the user modulation mapping list length.

**Return values:**

<Points> integer  
 Range: 0 to INT\_MAX  
 \*RST: 0

**Example:**

BB:DM:FORM USER  
 selects the User modulation type.  
 BB:DM:MLIS:POIN?  
 queries the list length.

**Usage:** Query only

---

### **[[:SOURce<hw>]:BB:DM:MLIS:SElect <Filename>**

Selects the user mapping list in the default directory. The default directory is set using command `MMEM:CDIRECTory`. A path can also be specified, in which case the files in the specified directory are selected. If a user mapping list with the specified name does not yet exist, it is created. The file extension may be omitted. Only files with the file extension `*.vam` will be selected or created.

**Parameters:**

<Filename> string

**Example:**

BB:DM:MLIS:SEL 'c\_list1'  
 selects the user mapping list `c_list1`.

**Manual operation:** See ["Load User Mapping"](#) on page 275

---

### **[[:SOURce<hw>]:BB:DM:SETTing:CATalog?**

Reads out the files with Custom Digital Modulation settings in the default directory. The default directory is set using command `MMEM:CDIRECTory`. Only files with the file extension `*.dm` will be listed.

**Return values:**

<Catalog> string

**Example:**

MMEM:CDIR 'D:\user\dig\_mod'  
 sets the default directory.  
 BB:DM:SETT:CAT?  
 reads out all the files with Custom Digital Modulation settings in the default directory.  
 Response: 'DM\_1'  
 the file `DM_1` with Custom Digital Modulation settings is available.



**Usage:** Query only  
**Manual operation:** See "Save/Recall" on page 270

**[SOURce<hw>]:BB:DM:SETTING:DELeTe <Filename>**

This command deletes the selected file with Custom Digital Modulation settings. The directory is set using command `MMEM:CDIRectory`. A path can also be specified, in which case the files in the specified directory are read. The file extension may be omitted. Only files with the file extension `*.dm` will be deleted.

**Setting parameters:**

<Filename> string

**Example:** `BB:DM:STAN:ULIS:DEL 'DM_1'`  
 deletes file `DM_1`.

**Usage:** Setting only  
**Manual operation:** See "Save/Recall" on page 270

**[SOURce<hw>]:BB:DM:SETTING:LOAD <Filename>**

This command loads the selected file with Custom Digital Modulation settings. The directory is set using command `MMEM:CDIRectory`. A path can also be specified, in which case the files in the specified directory are read. The file extension may be omitted. Only files with the file extension `*.dm` will be loaded.

**Setting parameters:**

<Filename> string

**Example:** `BB:DM:STAN:ULIS:LOAD 'DM_1'`  
 loads file `DM_1`.

**Usage:** Setting only  
**Manual operation:** See "Save/Recall" on page 270

**[SOURce<hw>]:BB:DM:SETTING:STORe <Filename>**

This command stores the current Custom Digital Modulation settings into the selected file. The directory is set using command `MMEM:CDIRectory`. A path can also be specified, in which case the files in the specified directory are read. Only the file name has to be entered. User Standards are stored as files with the specific file extensions `*.dm`.

**Setting parameters:**

<Filename> string

**Example:** `BB:DM:STAN:ULIS:STOR 'DM_QAM'`  
 stores the current Custom Digital Modulation settings into file `DM_QAM`.

**Usage:** Setting only

**Manual operation:** See ["Save/Recall"](#) on page 270

---

**[[:SOURce<hw>]:BB:DM:SETTing:STORe:FAST <Fast>**

Determines whether the instrument performs an absolute or a differential storing of the settings.

Enable this function to accelerate the saving process by saving only the settings with values different to the default ones.

**Note:** This function is not affected by the "Preset" function.

**Parameters:**

<Fast>                    0 | 1 | OFF | ON  
 \*RST:                    1

**Manual operation:** See ["Fast Save"](#) on page 169

---

**[[:SOURce<hw>]:BB:DM:STANdard:ULIS:t:CATalog?**

Reads out the files with Digital Standard settings in the default directory. The default directory is set using command `MMEM:CDIRectory`. Only files with the file extension `*.dm_stu` will be listed.

**Return values:**

<Catalog>                string

**Example:**

`MMEM:CDIR 'D:\user\dig_mod'`

sets the default directory.

`BB:DM:STAN:ULIS:CAT?`

reads out all the files with Digital Standard settings in the default directory.

Response: 'DM\_QAM'

the file `DM_QAM` with Digital Standard settings is available.

**Usage:**                    Query only

**Manual operation:** See ["Save/Recall User"](#) on page 274

---

**[[:SOURce<hw>]:BB:DM:STANdard:ULIS:DELete <Filename>**

Deletes the selected file with Digital Standard settings. The directory is set using command `MMEM:CDIRectory`. A path can also be specified, in which case the files in the specified directory are read. The file extension may be omitted. Only files with the file extension `*.dm_stu` will be deleted.

**Setting parameters:**

<Filename>                string

**Example:**

`BB:DM:STAN:ULIS:DEL 'DM_QAM'`

deletes file 'DM\_QAM'.

**Usage:**                    Setting only

**Manual operation:** See "Save/Recall User" on page 274

---

**[:SOURce<hw>]:BB:DM:STANdard:ULIS:LOAD <Filename>**

Loads the selected file with Digital Standard settings. The directory is set using command `MMEM:CDIRectory`. A path can also be specified, in which case the files in the specified directory are read. The file extension may be omitted. Only files with the file extension `*.dm_stu` will be loaded.

**Setting parameters:**

<Filename>                    string

**Example:**                    `BB:DM:STAN:ULIS:LOAD 'DM_QAM'`  
loads file 'DM\_QAM'.

**Usage:**                        Setting only

**Manual operation:** See "Save/Recall User" on page 274

---

**[:SOURce<hw>]:BB:DM:STANdard:ULIS:STORe <Filename>**

Stores the current Digital Standard settings into the selected file. The directory is set using command `MMEM:CDIRectory`. A path can also be specified, in which case the files in the specified directory are read. Only the file name has to be entered. User Standards are stored as files with the specific file extensions `*.dm_stu`.

**Setting parameters:**

<Filename>                    string

**Example:**                    `BB:DM:STAN:ULIS:STOR 'DM_QAM'`  
stores the current Digital Standard settings into file 'DM\_QAM'.

**Usage:**                        Setting only

**Manual operation:** See "Save/Recall User" on page 274

#### 7.15.2.4 SOURce:BB:GRAPhics Subsystem

This subsystem contains the commands used to setup the graphical display.

<code>[:SOURce&lt;hw&gt;]:BB:GRAPhics:MODE</code> .....	595
<code>[:SOURce&lt;hw&gt;]:BB:GRAPhics:SMART:STATE</code> .....	596
<code>[:SOURce&lt;hw&gt;]:BB:GRAPhics:SRATe:MODE</code> .....	596
<code>[:SOURce&lt;hw&gt;]:BB:GRAPhics:SRATe:USER</code> .....	597
<code>[:SOURce&lt;hw&gt;]:BB:GRAPhics:STATe</code> .....	597
<code>[:SOURce&lt;hw&gt;]:BB:GRAPhics:TRIGger:SOURce</code> .....	597

---

**[:SOURce<hw>]:BB:GRAPhics:MODE <Mode>**

Selects the graphical signal display.

**Parameters:**

<Mode> IQ | VECTor | CCDF | PSPectrum | CONStellation | EYEI | EYEQ  
 \*RST: IQ

**Example:**

BB:GRAP:MODE VECT  
 selects vector diagram.

**Manual operation:** See "[Mode](#)" on page 179

**[:SOURce<hw>]:BB:GRAPhics:SMARt:STATe <State>**

Activates/deactivates the "smart graphics".

**Parameters:**

<State> 0 | 1 | OFF | ON  
 \*RST: 0

**Example:**

BB:GRAP:SMAR:STAT ON  
 Activates smart graphics.

**Manual operation:** See "[Smart Graphics](#)" on page 179

**[:SOURce<hw>]:BB:GRAPhics:SRATe:MODE <Mode>**

Sets how the time resolution of the signal is determined. Maximum resolution corresponds to a display covering the entire signal bandwidth. The higher the resolution is, the shorter the length of the displayed signal segment will be for the specified recording depth.

**Parameters:**

<Mode> AUTO | FULL | USER

**AUTO**

The resolution is set to an optimum value on the basis of the signal and display type.

**FULL**

The resolution is set such that the display covers the entire signal bandwidth.

**USER**

with the command `SOUR:BB:GRAP:SRAT:USER`, the user can determine the resolution by setting the signal bandwidth for which the display is to be generated

\*RST: AUTO

**Example:**

BB:GRAP:SRAT:MODE FULL  
 sets the sample rate mode.

**Manual operation:** See "[Sample Rate Mode](#)" on page 180

---

**[ :SOURce<hw>]:BB:GRAPhics:SRATe:USER <User>**

(Enabled for BB:GRAP:SRAT:MODE USER)

Selects the signal bandwidth for which the display is to be generated. The setting range moves between the minimum and maximum bandwidth which is possible for the selected display. The selection is made graphically by moving the pointer.

**Parameters:**

<User> float  
 Range: 0.01 to 100  
 Increment: 0.01  
 \*RST: 10  
 Default unit: PCT

**Example:**

BB:GRAP:SRAT:MODE USER  
 sets the sample rate mode.  
 BB:GRAP:SRAT:USER 20  
 sets the sample rate factor.

**Manual operation:** See "[Graphics Sample Rate](#)" on page 180

---

**[ :SOURce<hw>]:BB:GRAPhics:STATe <State>**

Activates/deactivates the selected graphical display.

**Parameters:**

<State> 0 | 1 | OFF | ON  
 \*RST: 0

**Example:**

BB:GRAP:STAT ON  
 activates the graphical graphics.

**Manual operation:** See "[State](#)" on page 179

---

**[ :SOURce<hw>]:BB:GRAPhics:TRIGger:SOURce <Source>**

Defines the trigger for the starting time of the graphic recording.

**Parameters:**

&lt;Source&gt;                   SOFTware | MARKer

**SOFTware**

Recording of signals is started automatically in specified intervals. This asynchronous method is appropriate when a representative display of the complete signal is desired, as recording starts in a random time reference to the signal.

**MARKer**

The starting point for recording signals is determined by "Marker 1" in the menu of the active standard.

This synchronous method is appropriate when specific signal segments are to be shown in greater detail. With periodic signals, a static image is obtained by selecting a period length of "Marker 1" that is equal to the signal period.

The displayed signal segment can be shifted as needed by entering a "Marker Delay" in the "Trigger/Marker" menu of the active standard.

\*RST:           SOFTware

**Example:**

```
BB:GRAP:TRIG:SOUR MARK
sets the trigger source.
```

**Manual operation:** See "[Trigger Source](#)" on page 179**7.15.2.5 SOURce:BB:IMPairment Subsystem**

This subsystem contains the commands for the digital I/Q impairments.

<a href="#">[:SOURce&lt;hw&gt;]:BB:IMPairment:IQRatio[:MAGNitude]</a> .....	598
<a href="#">[:SOURce&lt;hw&gt;]:BB:IMPairment:LEAKage:I</a> .....	599
<a href="#">[:SOURce&lt;hw&gt;]:BB:IMPairment:LEAKage:Q</a> .....	599
<a href="#">[:SOURce&lt;hw&gt;]:BB:IMPairment:QUADrature[:ANGLE]</a> .....	600
<a href="#">[:SOURce&lt;hw&gt;]:BB:IMPairment:STATe</a> .....	600

**[\[:SOURce<hw>\]:BB:IMPairment:IQRatio\[:MAGNitude\]](#) <IqRatio>**

This command sets the ratio of I modulation to Q modulation (amplification "imbalance"). The input may be either in dB or %. The resolution is 0.001 dB, an input in percent is rounded to the closest valid value in dB. A query returns the value in dB.

**Parameters:**

```
<IqRatio>                   float
Range:           -1 to 1
Increment:       1E-4
*RST:            0
```

- Example:** `BB:IMP:IQR 3 PCT`  
sets the imbalance to 3 percent.  
`BB:IMP:IQR?`  
queries the imbalance.  
Response: 0.259000  
the value is returned in dB
- Options:** R&S AMU-B13 and -K62; SOURce2 only with a second option R&S AMU-B13 and at least one of the options R&S AMU-B9/10/11 or -B17
- Manual operation:** See "[Gain Imbalance - Digital Impairments](#)" on page 226

**[:SOURce<hw>]:BB:IMPairment:LEAKage:I <I>**

This command sets the carrier leakage amplitude for the I-signal component.

**Parameters:**

<I> float  
Range: -10 to 10  
Increment: 0.01  
\*RST: 0  
Default unit: PCT

**Example:** `BB:IMP:LEAK:I 3 PCT`  
sets the leakage for the I-component to 3 percent.

**Options:** R&S AMU-B13 and -K62; SOURce2 only with a second option R&S AMU-B13 and at least one of the options R&S AMU-B9/10/11 or -B17

**Manual operation:** See "[I/Q Offset - Digital Impairments](#)" on page 226

**[:SOURce<hw>]:BB:IMPairment:LEAKage:Q <Q>**

This command sets the carrier leakage amplitude for the Q-signal component.

**Parameters:**

<Q> float  
Range: -10 to 10  
Increment: 0.01  
\*RST: 0  
Default unit: PCT

**Example:** `BB:IMP:LEAK:Q 3 PCT`  
sets the leakage for the Q-component to 3 percent.

**Options:** R&S AMU-B13 and -K62; SOURce2 only with a second option R&S AMU-B13 and at least one of the options R&S AMU-B9/10/11 or -B17

**Manual operation:** See "[I/Q Offset - Digital Impairments](#)" on page 226

---

**[:SOURce<hw>]:BB:IMPairment:QUADrature[:ANGLe] <Angle>**

This command sets the quadrature offset for the digital I/Q signal.

**Parameters:**

<Angle> float  
 Range: -10 to 10  
 Increment: 0.01  
 \*RST: 0  
 Default unit: DEG

**Example:** BB:IMP:QUAD:ANGL -5DEG  
 sets the quadrature offset to -5 degrees.

**Options:** R&S AMU-B13 and -K62; SOURce2 only with a second option R&S AMU-B13 and at least one of the options R&S AMU-B9/10/11 or -B17

**Manual operation:** See "[Quadrature Offset - Digital Impairments](#)" on page 226

---

**[:SOURce<hw>]:BB:IMPairment:STATe <State>**

The command activates (ON) and deactivates (OFF) the three impairment or correction values LEAKage, QUADrature and IQRatio for the digital baseband signal prior to input into the I/Q modulator.

**Parameters:**

<State> 0 | 1 | OFF | ON  
 \*RST: 0

**Example:** BB:IMP:STAT OFF  
 deactivates digital impairment.

**Options:** R&S AMU-B13 and -K62; SOURce2 only with a second option R&S AMU-B13 and at least one of the options R&S AMU-B9/10/11 or -B17

**Manual operation:** See "[State - Digital Impairments](#)" on page 225

### 7.15.2.6 SOURce:BB:MCCW Subsystem

This subsystem contains the commands for setting the Multi Carrier CW signals.

**Suffixes**

SOURce<hw>

For one-path instruments, the keyword SOURce is optional and can be omitted.

The numeric suffix to SOURce distinguishes between signal generation for path A and path B in the case of two-path instruments:

- SOURce[1] = path A  
 The keyword SOURce is optional and can be omitted



- `SOURce2` = path B  
The keyword `SOURce` is mandatory, i.e. the command must contain the keyword with suffix 2.

**OUTPut<ch>**

The numeric suffix to `OUTPut` distinguishes between the available markers.

**General Settings and Carrier Setup Settings**

<code>[SOURce&lt;hw&gt;]:BB:MCCW:STATe</code> .....	601
<code>[SOURce&lt;hw&gt;]:BB:MCCW:PRESet</code> .....	601
<code>[SOURce&lt;hw&gt;]:BB:MCCW:CARRier:COUNT</code> .....	602
<code>[SOURce&lt;hw&gt;]:BB:MCCW:CARRier:LIST:PHASe</code> .....	602
<code>[SOURce&lt;hw&gt;]:BB:MCCW:CARRier:LIST:POWer</code> .....	603
<code>[SOURce&lt;hw&gt;]:BB:MCCW:CARRier:LIST:STATe</code> .....	604
<code>[SOURce&lt;hw&gt;]:BB:MCCW:CARRier:PHASe</code> .....	604
<code>[SOURce&lt;hw&gt;]:BB:MCCW:CARRier:POWer</code> .....	605
<code>[SOURce&lt;hw&gt;]:BB:MCCW:CARRier:SPACing</code> .....	605
<code>[SOURce&lt;hw&gt;]:BB:MCCW:CARRier:STATe</code> .....	605
<code>[SOURce&lt;hw&gt;]:BB:MCCW:CFACTor</code> .....	606
<code>[SOURce&lt;hw&gt;]:BB:MCCW:CFACTor:ACTual?</code> .....	606
<code>[SOURce&lt;hw&gt;]:BB:MCCW:CFACTor:MODE</code> .....	606
<code>[SOURce&lt;hw&gt;]:BB:MCCW:CLOCK?</code> .....	607
<code>[SOURce&lt;hw&gt;]:BB:MCCW:EDIT:CARRier:EXECute</code> .....	607
<code>[SOURce&lt;hw&gt;]:BB:MCCW:EDIT:CARRier:PHASe:STEP</code> .....	608
<code>[SOURce&lt;hw&gt;]:BB:MCCW:EDIT:CARRier:PHASe[:START]</code> .....	608
<code>[SOURce&lt;hw&gt;]:BB:MCCW:EDIT:CARRier:POWer:STEP</code> .....	609
<code>[SOURce&lt;hw&gt;]:BB:MCCW:EDIT:CARRier:POWer[:START]</code> .....	609
<code>[SOURce&lt;hw&gt;]:BB:MCCW:EDIT:CARRier:START</code> .....	610
<code>[SOURce&lt;hw&gt;]:BB:MCCW:EDIT:CARRier:STATe</code> .....	610
<code>[SOURce&lt;hw&gt;]:BB:MCCW:EDIT:CARRier:STOP</code> .....	610

**[SOURce<hw>]:BB:MCCW:STATe <State>**

Activates the multi carrier CW signal generation and deactivates all the other digital standards and digital modulation modes in the same path.

**Parameters:**

<State>            0 | 1 | OFF | ON  
\*RST:            0

**Example:**            `SOURce1:BB:MCCW:STATe ON`

**Manual operation:**    See "[State](#)" on page 355

**[SOURce<hw>]:BB:MCCW:PRESet**

Sets the multi carrier signal parameters to their default values (\*RST values specified for the commands).

Not affected is the state set with the command `SOURce<hw>:BB:MCCW:STATe`

**Example:** SOURce1:BB:MCCW:PRESet

**Usage:** Event

**Manual operation:** See ["Set to Default"](#) on page 355

**[:SOURce<hw>]:BB:MCCW:CARRier:COUNT <Count>**

Sets the number of carriers in the Multi Carrier CW signal. The total bandwidth is calculated as (Number of carriers - 1) \* Carrier spacing and must not exceed the system bandwidth of the instrument (see data sheet).

The carrier spacing (:BB:MCCW:CARRier:SPACing) is reduced if the total bandwidth is not respected when entering the number of carriers.

The number of carriers entered therefore defines the maximum carrier spacing (:BB:MCCW:CARRier:SPACing).

**Parameters:**

<Count> integer  
 Range: 1 to 8192  
 \*RST: 64

**Example:** BB:MCCW:CARR:COUN 10  
 sets 10 CW carriers for the multi carrier signal.

**Manual operation:** See ["Number of Carriers"](#) on page 356

**[:SOURce<hw>]:BB:MCCW:CARRier:LIST:PHASe <Phas0[,Phas1..]>**  
**[:SOURce<hw>]:BB:MCCW:CARRier:LIST:PHASe? [<Start>[, <Count>]]**

Sets the start phase of the carrier with the aid of a value list. The first value in the list is assigned to the carrier with index 0, the second value to the carrier with index 1, etc. The maximum length corresponds to the maximum number of multi carriers. There is no need to enter all the values every time. Values not set by the value list are set with the default values provided they have already been explicitly set by a previous command. If this is the case, the values continue to apply until overwritten.

**Setting parameters:**

<Phas0[,Phas1..]> float  
 Range: 0 to 360  
 Increment: 0.01  
 \*RST: 0  
 Default unit: DEG

**Query parameters:**

<Start> integer  
 Range: 0 to lastCarrier  
 <Count> integer  
 Range: 1 to lastCarrier

**Return values:**

<Phas[,Phas..]> float

**Example:**

BB:MCCW:CARR:LIST:PHAS 1, 20, 30, 40, 50, 60

sets a start phase for carriers 0, 1, 2, 3 and 4.

BB:MCCW:CARR:LIST:PHAS? 2, 3

queries the phase of carrier 1, 2 and 3.

Response: 20, 30, 40

**Manual operation:** See "[Carrier Table](#)" on page 359

**[[:SOURce<hw>]:BB:MCCW:CARRIER:LIST:POWER <Pow0[,Pow1..]]**

**[[:SOURce<hw>]:BB:MCCW:CARRIER:LIST:POWER? <Start>, <Count>**

Sets the power of the carrier with the aid of a value list. The first value in the list is assigned to the carrier with index 0, the second value to the carrier with index 1, etc. The maximum length corresponds to the maximum number of multi carriers. There is no need to enter all the values every time. Values not set by the value list are set with the default values provided they have already been explicitly set by a previous command. If this is the case, the values continue to apply until overwritten.

**Setting parameters:**

<Pow0[,Pow1..]> float

Increment: 0.01

**Query parameters:**

<Start> integer

Range: 0 to lastCarrier

<Count> integer

Range: 1 to lastCarrier

**Return values:**

<Pow[,Pow..]> float

**Example:**

BB:MCCW:CARR:LIST:POW -65 dB, -30 dB, -50 dB, . . .

sets the power of carrier 0 to -65 dB, carrier 1 to -30 dB and so on.

BB:MCCW:CARR:LIST:POW? 2, 3

queries the power of carrier 1 and 2.

Response: -30, -50

**Manual operation:** See "[Carrier Table](#)" on page 359

---

```
[:SOURce<hw>]:BB:MCCW:CARRier:LIST:STATe <Stat0[,Stat1..]>
[:SOURce<hw>]:BB:MCCW:CARRier:LIST:STATe? <Start>, <Count>
```

Switches the carrier on or off with the aid of a value list. The first value in the list is assigned to the carrier with index 0, the second value to the carrier with index 1, etc. The maximum length corresponds to the maximum number of multi carriers. There is no need to enter all the values every time. Values not set by the value list are set with the default values provided they have already been explicitly set by a previous command. If this is the case, the values continue to apply until overwritten.

**Setting parameters:**

```
<Stat0[,Stat1..]> ON | OFF[,ON | OFF,...]
```

**Query parameters:**

```
<Start> integer
Range: 0 to lastCarrier
```

```
<Count> integer
Range: 1 to lastCarrier
```

**Return values:**

```
<State[,State..]> select
```

**Example:**

```
BB:MCCW:CARR:LIST:STAT 1,0,1,1,0,0...
switches carrier 0 on, carrier 1 off, etc.
BB:MCCW:CARR:LIST:STAT? 2,4
queries the states of carrier 2, 3, 4 and 5.
Response: 0, 1, 1, 0
```

**Manual operation:** See "[Carrier Table](#)" on page 359

---

```
[:SOURce<hw>]:BB:MCCW:CARRier:PHASe <CarrierIndex>, <Phase>
```

Sets the start phase of the selected carrier.

The phase settings are only valid if optimization of the crest factor is disabled (:SOURce:BB:MCCW:CFACTOR:MODE OFF).

**Parameters:**

```
<CarrierIndex> integer
Range: 0 to lastCarrier
```

```
<Phase> float
Sets the start phase of the selected carrier.
Range: 0 to 359.99
Increment: 0.01
*RST: 0
Default unit: DEG
```

**Example:** BB:MCCW:CARR:PHAS 15, 90  
sets a start phase of 90 DEG for carrier 15.

**Manual operation:** See "[Carrier Table](#)" on page 359

---

```
[:SOURce<hw>]:BB:MCCW:CARRier:POWer <CarrierIndex>, <Power>
```

Sets the power of the selected carrier.

**Parameters:**

```
<CarrierIndex>      integer
                    Range:    0 to lastCarrier

<Power>             float
                    Sets the power of the selected carrier.
                    Range:    -80 to 0
                    Increment: 0.01
                    *RST:    0
```

**Example:**           BB:MCCW:CARR:POW 15, -50 dB  
sets the power of carrier 15 to -50 dB.

**Manual operation:** See "[Carrier Table](#)" on page 359

---

```
[:SOURce<hw>]:BB:MCCW:CARRier:SPACing <Spacing>
```

The command sets the carrier spacing.

The carriers are generated symmetrically around the center carrier. The total bandwidth is calculated as ("Number of carriers" - 1) \* "Carrier spacing" and must not exceed the system bandwidth of the instrument (see data sheet).

The maximum carrier spacing that can be set is dependent on the chosen number of carriers

The maximum carrier spacing is automatically reduced so that the maximum total bandwidth is not exceeded on entering the number of carriers  
(:BB:MCCW:CARRier:COUNT).

**Parameters:**

```
<Spacing>           float
                    Range:    0 to 120E6
                    Increment: 0.01
                    *RST:    10E3
```

**Example:**           BB:MCCW:CARR:SPAC 10 MHz  
sets a carrier spacing of 10 MHz.

**Manual operation:** See "[Carrier Spacing](#)" on page 357

---

```
[:SOURce<hw>]:BB:MCCW:CARRier:STATe <CarrierIndex>, <State>
```

Switches the selected carrier on or off.

The counting in remote control differs from the numbers in the carrier table. Index 0 corresponds to number 1 (first line) in the table. Therefore, switching the state of the channel via remote control always switches the state of <channel index> + 1 in the table.

**Parameters:**

<CarrierIndex> integer  
 Range: 0 to lastCarrier

<State> select  
 \*RST: 0

**Example:** BB:MCCW:CARR:STAT 15, ON  
 switches carrier 16 on.

**Manual operation:** See "[Carrier Table](#)" on page 359

**[[:SOURce<hw>]:BB:MCCW:CFACtor <CFactor>**

Sets the desired crest factor for the multi carrier signal on selection of the command  
 SOUR:BB:MCCW:CFAC:MODE SLOW.

**Parameters:**

<CFactor> float  
 Range: 0 to 30  
 Increment: 0.01  
 \*RST: 3

**Example:** BB:MCCW:CFAC:MODE SLOW  
 sets the Target Crest optimization mode.  
 BB:MCCW:CFAC 10 dB  
 sets the desired crest factor to 10 dB.

**Manual operation:** See "[Desired Crest Factor](#)" on page 358

**[[:SOURce<hw>]:BB:MCCW:CFACtor:ACTual?**

Queries the actual Crest Factor for BB:MCCW:CFAC:MODE SLOW.

**Return values:**

<Actual> float  
 Range: 0 to 100  
 Increment: 0.01  
 \*RST: 3

**Example:** SOUR:BB:MCCW:CFAC:MODE SLOW  
 BB:MCCW:CFAC:ACT?  
 Response: 3

**Usage:** Query only

**[[:SOURce<hw>]:BB:MCCW:CFACtor:MODE <Mode>**

Sets the mode by which automatic settings will minimize the crest factor or hold it at a chosen value.

**Parameters:**

&lt;Mode&gt;

OFF | CHIRp | SLOW

**OFF**

Crest factor optimization is switched off. The carrier PHASE setting has an effect.

**CHIRp**

The crest factor is very rapidly optimized to < 3 dB for multi carrier signals so that all carriers are switched on and have the same amplitude. The computation time is independent of the number of carriers. In other carrier configurations the achievable crest factor is worse.

**SLOW**

The crest factor entered using `SOURceBB:MCCW:CFACtor` is maintained for all carrier configurations by means of automatic settings. The computation time depends on the number of carriers and on the crest factor that has been set. Computation time increases only when the number of carriers exceeds 256 and the crest factor is above 4 dB.

\*RST: CHIRp

**Example:**

BB:MCCW:CFAC:MODE OFF

switches off automatic crest factor optimization.

The setting `SOURBB:MCCW:CARR:PHAS` has an effect.

**Manual operation:** See "[Optimize Crest Factor Mode](#)" on page 357

**[[:SOURce<hw>]:BB:MCCW:CLOCK?**

Queries the output clock rate. The output clock rate depends on the number of carriers and the selected carrier spacing.

**Return values:**

&lt;Clock&gt;

float

Range: 0 to Max

Increment: 1E-3

\*RST: 0

**Example:**

BB:MCCW:CLOC?

queries the output clock rate.

Response: 256 000 000

the output clock rate is 256 MHz.

**Usage:**

Query only

**Manual operation:** See "[Clock Frequency](#)" on page 357

**[[:SOURce<hw>]:BB:MCCW:EDIT:CARRIER:EXECute**

Adopts the settings for the carrier range which has been defined using the `:BB:MCCW:EDIT:CARR:...` commands.

**Example:** `BB:MCCW:EDIT:CARR:STAR 4`  
the carrier range starts at carrier 4.  
`BB:MCCW:EDIT:CARR:STOP 400`  
the carrier range stops at carrier 400.  
`BB:MCCW:EDIT:CARR:STAT ON`  
sets all the carriers in the carrier range to ON.  
`BB:MCCW:EDIT:CARR:EXEC`  
adopts the settings for all the carriers in the carrier range.  
`BB:MCCW:STAT`  
starts generation of the multi carrier signal. Carriers 4 to 400 are in the ON state.

**Usage:** Event

**Manual operation:** See ["Accept"](#) on page 359

**[:SOURce<hw>]:BB:MCCW:EDIT:CARRier:PHASe:STEP <Step>**

Sets the step width by which the start phases of the carriers in the defined carrier range will be incremented.

The phase settings are only valid if optimization of the crest factor is disabled (`:SOURce:BB:MCCW:CFACTOR:MODE OFF`).

**Parameters:**

<Step> float  
Range: -359.99 to 359.99  
Increment: 0.01  
\*RST: 0

**Example:** `BB:MCCW:EDIT:CARR:PHAS 90 DEG`  
sets a start phase of 90° for the carriers in the carrier range.  
`BB:MCCW:EDIT:CARR:PHAS:STEP 1 DEG`  
the start phase is incremented by 1° for each carrier, i.e. the first carrier has a start phase of 90°, the second a start phase of 91°, etc.

**Manual operation:** See ["Phase Step"](#) on page 359

**[:SOURce<hw>]:BB:MCCW:EDIT:CARRier:PHASe[:START] <Start>**

Sets the start phase for the individual carriers in the defined carrier range. If the command `:BB:MCCW:EDIT:CARR:PHAS:STEP` is used to define a step width, the phase entered here applies only to the starting carrier. The phases of the remaining carriers are stepped up or down by the phase value specified in the `:BB:MCCW:EDIT:CARR:PHAS:STEP` command.

The phase settings are only valid if optimization of the crest factor is disabled (`:SOURce:BB:MCCW:CFACTOR:MODE OFF`).



**Parameters:**

<Start> float  
 Range: 0 to 359.99  
 Increment: 0.01  
 \*RST: 0

**Example:**

BB:MCCW:EDIT:CARR:PHAS 90 DEG  
 sets a start phase of 90° for the carriers in the carrier range.

**Manual operation:** See "[Phase Start](#)" on page 358

**[:SOURce<hw>]:BB:MCCW:EDIT:CARRIER:POWER:STEP <Step>**

Sets the step width by which the starting power of the carriers in the defined carrier range will be incremented.

**Parameters:**

<Step> float  
 Range: -80 to 80  
 Increment: 0.01  
 \*RST: 0

**Example:**

BB:MCCW:EDIT:CARR:POW -80dB  
 sets a power of -80 dB for the carriers in the carrier range.  
 BB:MCCW:EDIT:CARR:POW:STEP 1 dB  
 the power phase is incremented by dB for each carrier, i.e. the first carrier has -80 dB, the second -79 dB, etc.

**Manual operation:** See "[Power Step](#)" on page 358

**[:SOURce<hw>]:BB:MCCW:EDIT:CARRIER:POWER[:START] <Start>**

Sets the power for the individual carriers in the defined carrier range. If the command `:BB:MCCW:EDIT:CARR:POW:STEP` is used to define a step width, the power entered here applies only to the starting carrier. The power of the remaining carriers is stepped up or down by the power specified in the `:BB:MCCW:EDIT:CARR:POW:STEP` command.

**Parameters:**

<Start> float  
 Range: -80 to 0  
 Increment: 0.01  
 \*RST: 0

**Example:**

BB:MCCW:EDIT:CARR:POW -50 dB  
 sets the power of the carrier to -50 dB.

**Manual operation:** See "[Power Start](#)" on page 358

**[[:SOURce<hw>]:BB:MCCW:EDIT:CARRIER:START <Start>**

Selects the first carrier in the carrier range to which the settings with the :BB:MCCW:EDIT:CARR:... commands shall apply.

**Parameters:**

<Start> integer  
 Range: 0 to 8191  
 \*RST: 0

**Example:** BB:MCCW:EDIT:CARR:STAR 4  
 the carrier range starts at carrier 4.

**Manual operation:** See "Carrier Start" on page 358

**[[:SOURce<hw>]:BB:MCCW:EDIT:CARRIER:STATE <State>**

Switches all the carriers in the selected carrier range on or off.

**Parameters:**

<State> 0 | 1 | OFF | ON  
 \*RST: 1

**Example:** BB:MCCW:EDIT:CARR:STAT ON  
 sets all the carriers in the carrier range to ON.

**Manual operation:** See "Carrier State" on page 358

**[[:SOURce<hw>]:BB:MCCW:EDIT:CARRIER:STOP <Stop>**

Selects the last carrier in the carrier range to which the settings with the :BB:MCCW:EDIT:CARR:... commands shall apply.

**Parameters:**

<Stop> integer  
 Range: 0 to 8191  
 \*RST: 0

**Example:** BB:MCCW:EDIT:CARR:STOP 40  
 the carrier range stops at carrier 40.

**Manual operation:** See "Carrier Stop" on page 358

**Trigger Settings**

[[:SOURce<hw>]:BB:MCCW:TRIGger:ARM:EXECute.....	611
[[:SOURce<hw>]:BB:MCCW:TRIGger:EXECute.....	611
[[:SOURce<hw>]:BB:MCCW:TRIGger:EXTernal:SYNChronize:OUTPut.....	611
[[:SOURce<hw>]:BB:MCCW:TRIGger:OBASeband:DELay.....	612
[[:SOURce<hw>]:BB:MCCW:TRIGger:OBASeband:INHibit.....	612
[[:SOURce<hw>]:BB:MCCW:TRIGger:RMODE?.....	613
[[:SOURce<hw>]:BB:MCCW:TRIGger:SLENgth.....	613
[[:SOURce<hw>]:BB:MCCW:TRIGger:SOURce.....	614

<code>[:SOURce&lt;hw&gt;]:BB:MCCW:TRIGger[:EXTErnal&lt;ch&gt;]:DELay</code> .....	614
<code>[:SOURce&lt;hw&gt;]:BB:MCCW:TRIGger[:EXTErnal&lt;ch&gt;]:INHibit</code> .....	614
<code>[:SOURce&lt;hw&gt;]:BB:MCCW[:TRIGger]:SEQuence</code> .....	615

---

### `[:SOURce<hw>]:BB:MCCW:TRIGger:ARM:EXECute`

Stops signal generation for trigger modes Armed\_Auto and Armed\_Retrigger. A subsequent internal or external trigger event restart signal generation.

**Example:**

```
BB:MCCW:TRIG:SOUR INT
sets internal triggering.
BB:MCCW:TRIG:SEQ ARET
sets Armed_Retrigger mode, i.e. every trigger event causes signal
generation to restart.
BB:MCCW:TRIG:EXEC
executes a trigger, signal generation is started.
BB:MCCW:TRIG:ARM:EXEC
signal generation is stopped.
BB:MCCW:TRIG:EXEC
executes a trigger, signal generation is started again.
```

**Usage:** Event

**Manual operation:** See "[Arm](#)" on page 363

---

### `[:SOURce<hw>]:BB:MCCW:TRIGger:EXECute`

Executes a trigger. The internal trigger source must be selected using the command `MCCW:TRIGger:SOURce INTernal` and a trigger mode other than AUTO must be selected using the command `:BB:MCCW:TRIGger:MODE`.

**Example:**

```
BB:MCCW:TRIG:SOUR INT
sets internal triggering.
BB:MCCW:TRIG:SEQ RETR
sets Retrigger mode, i.e. every trigger event causes signal gen-
eration to restart.
BB:MCCW:TRIG:EXEC
executes a trigger.
```

**Usage:** Event

**Manual operation:** See "[Execute Trigger](#)" on page 363

---

### `[:SOURce<hw>]:BB:MCCW:TRIGger:EXTErnal:SYNChronize:OUTPut <Output>`

(enabled for Trigger Source External)

Enables/disables output of the signal synchronous to the external trigger event.

**Parameters:**

&lt;Output&gt; 0 | 1 | OFF | ON

**ON**

The signal calculation starts simultaneously with the external trigger event but because of the instrument's processing time the first samples are cut off and no signal is outputted. After elapsing of the internal processing time, the output signal is synchronous to the trigger event.

**OFF**

The signal output begins after elapsing of the processing time and starts with sample 0, i.e. the complete signal is outputted. This mode is recommended for triggering of short signal sequences with signal duration comparable with the processing time of the instrument.

\*RST: 1

**Example:**

BB:MCCW:TRIG:SOUR EXT

sets external triggering.

BB:MCCW:TRIG:EXT:SYNC:OUTP ON

enables synchronous output to external trigger.

**Manual operation:** See "[Sync. Output to External Trigger](#)" on page 363**[[:SOURce<hw>]:BB:MCCW:TRIGger:OBASeband:DELay <Delay>**

Sets the trigger delay for external triggering.

**Parameters:**

&lt;Delay&gt; float

Range: 0 to 65535

Increment: 0.01

\*RST: 0

**Example:**

BB:MCCW:TRIG:SOUR EXT

selects an external trigger

BB:MCCW:TRIG:DEL 200

sets a delay of 200 samples for the trigger.

**Manual operation:** See "[Trigger Delay](#)" on page 364**[[:SOURce<hw>]:BB:MCCW:TRIGger:OBASeband:INHibit <Inhibit>**

Sets the number of samples by which a restart is to be inhibited following a trigger event. This command applies only in the case of external triggering.

**Parameters:**

&lt;Inhibit&gt; integer

Range: 0 to 67108863

\*RST: 0

**Example:** BB:MCCW:TRIG:SOUR EXT  
selects an external trigger  
BB:MCCW:TRIG:INH 200  
sets a restart inhibit for 200 samples following a trigger event.

**Manual operation:** See ["Trigger Inhibit"](#) on page 365

#### **[:SOURce<hw>]:BB:MCCW:TRIGger:RMODE?**

Queries the current status of signal generation for all trigger modes with Multi Carrier CW on.

**Return values:**

<RMode>

STOP | RUN

**RUN**

The signal is generated. A trigger event occurred in the triggered mode.

**STOP**

The signal is not generated. A trigger event did not occur in the triggered modes, or signal generation was stopped by the command BB:MCCW:TRIG:ARM:EXECute (armed trigger modes only).

**Example:** SOURBB:MCCW:TRIG:SOUR EXT  
sets external triggering  
SOURBB:MCCW:TRIG:MODE ARET  
selects the Armed\_Retrigger mode  
SOURBB:MCCW:TRIG:RMODE?  
queries the current status of signal generation.  
Response: RUN  
the signal is generated, an external trigger was executed.

**Usage:** Query only

**Manual operation:** See ["Running/Stopped"](#) on page 362

#### **[:SOURce<hw>]:BB:MCCW:TRIGger:SLENgth <SLength>**

Sets the length of the signal sequence to be output in the "Single" trigger mode. The input is to be expressed in samples. It is then possible to output deliberately just part of the waveform, an exact sequence of the waveform, or a defined number of repetitions of the waveform.

**Parameters:**

<SLength>

integer

Range: 1 to 1000

\*RST: 1

**Example:**           SOURBB:MCCW:SEQ SING  
sets trigger mode Single.  
SOURBB:MCCW:TRIG:SLEN 200  
sets a sequence length of 200 samples. The first 200 samples of  
the current waveform will be output after the next trigger event.

**Manual operation:** See ["Signal Duration"](#) on page 362

**[:SOURce<hw>]:BB:MCCW:TRIGger:SOURce <Source>**

Selects the trigger source.

**Parameters:**

<Source>           INTernal|OBASeband|BEXTernal|EXTernal  
**INTernal**  
manual trigger or \*TRG.  
**EXTernal | BEXTernal**  
trigger signal on the TRIGGER 1/2 connector.  
**OBASeband**  
trigger signal from the other path  
\*RST:           INTernal

**Example:**           SOURce1:BB:MCCW:TRIGger:SOURce EXTernal  
sets external triggering via the TRIGGER 1 connector.

**Manual operation:** See ["Trigger Source"](#) on page 363

**[:SOURce<hw>]:BB:MCCW:TRIGger[:EXTernal<ch>]:DELay <Delay>**

Specifies the trigger delay (expressed as a number of samples) for external triggering.

**Parameters:**

<Delay>           float  
Range:           0 to 65535  
Increment:       0.01  
\*RST:           0

**Example:**           BB:MCCW:TRIG:SOUR EXT  
selects an external trigger  
BB:MCCW:TRIG:DEL 200  
sets a delay of 200 samples for the trigger.

**Manual operation:** See ["Trigger Delay"](#) on page 364

**[:SOURce<hw>]:BB:MCCW:TRIGger[:EXTernal<ch>]:INHibit <Inhibit>**

Specifies the number of samples by which a restart is to be inhibited following a trigger event. This command applies only in the case of external triggering.

**Parameters:**

<Inhibit> integer  
 Range: 0 to 67108863  
 \*RST: 0

**Example:**

BB:MCCW:TRIG:SOUR EXT  
 selects an external trigger  
 BB:MCCW:TRIG:INH 200  
 sets a restart inhibit for 200 samples following a trigger event.

**Manual operation:** See ["Trigger Inhibit"](#) on page 365

**[:SOURce<hw>]:BB:MCCW[:TRIGger]:SEQUence <Sequence>**

Selects the trigger mode.

**Parameters:**

<Sequence> AUTO | RETRigger | AAUTo | ARETrigger | SINGLE

**AUTO**  
 The multi carrier signal is generated continuously.

**RETRigger**  
 The multi carrier signal is generated continuously. A trigger event (internal or external) causes a restart.

**AAUTo**  
 The multi carrier signal is generated only when a trigger event occurs. After the trigger event the signal is generated continuously. Signal generation is stopped with command `SOURBB:MCCW:TRIG:ARM:EXEC` and started again when a trigger event occurs.

**ARETrigger**  
 The multi carrier signal is generated only when a trigger event occurs. The device automatically toggles to RETRIG mode. Every subsequent trigger event causes a restart. Signal generation is stopped with command `SOURBB:MCCW:TRIG:ARM:EXEC` and started again when a trigger event occurs.

**SINGLE**  
 The multi carrier signal is output only when a trigger event occurs. After the trigger event the signal is output once to the set sequence length (`SOURBB:MCCW:TRIG:SLen`). Every subsequent trigger event causes a restart.

\*RST: AUTO

**Example:**

BB:MCCW:SEQ AAUT  
 sets the "Armed\_auto" trigger mode; the device waits for the first trigger (e.g. with \*TRG) and then generates the signal continuously.

**Manual operation:** See ["Trigger Mode"](#) on page 362

## Marker Settings

This section lists the remote control commands, necessary to configure the markers.



The marker delay settings are available for R&S SMx and R&S AMU instruments only.

<code>[:SOURce&lt;hw&gt;]:BB:MCCW:TRIGger:OUTPut:DELay:FIXed</code> .....	616
<code>[:SOURce&lt;hw&gt;]:BB:MCCW:TRIGger:OUTPut&lt;ch&gt;:DELay</code> .....	616
<code>[:SOURce&lt;hw&gt;]:BB:MCCW:TRIGger:OUTPut&lt;ch&gt;:DELay:MAXimum?</code> .....	617
<code>[:SOURce&lt;hw&gt;]:BB:MCCW:TRIGger:OUTPut&lt;ch&gt;:DELay:MINimum?</code> .....	617
<code>[:SOURce&lt;hw&gt;]:BB:MCCW:TRIGger:OUTPut&lt;ch&gt;:MODE</code> .....	618
<code>[:SOURce&lt;hw&gt;]:BB:MCCW:TRIGger:OUTPut&lt;ch&gt;:OFFTime</code> .....	618
<code>[:SOURce&lt;hw&gt;]:BB:MCCW:TRIGger:OUTPut&lt;ch&gt;:ONTime</code> .....	618
<code>[:SOURce&lt;hw&gt;]:BB:MCCW:TRIGger:OUTPut&lt;ch&gt;:PATTern</code> .....	619
<code>[:SOURce&lt;hw&gt;]:BB:MCCW:TRIGger:OUTPut&lt;ch&gt;:PULSe:DIVider</code> .....	619
<code>[:SOURce&lt;hw&gt;]:BB:MCCW:TRIGger:OUTPut&lt;ch&gt;:PULSe:FREQuency?</code> .....	619

### `[:SOURce<hw>]:BB:MCCW:TRIGger:OUTPut:DELay:FIXed` <Fixed>

Restricts the marker delay setting range to the dynamic range. In this range the delay can be set without restarting the marker and signal. If a delay is entered in setting ON but is outside this range, the maximum possible delay is set and an error message is generated.

The numeric suffix in OUTPut has no significance for this command, since the setting always affects every marker.

#### Parameters:

<Fixed>            0 | 1 | OFF | ON  
 \*RST:            0

#### Example:

`BB:MCCW:TRIG:OUTP:DEL:FIX ON`  
 restricts the marker signal delay setting range to the dynamic range.

**Manual operation:** See "[Fix marker delay to current range](#)" on page 366

### `[:SOURce<hw>]:BB:MCCW:TRIGger:OUTPut<ch>:DELay` <Delay>

Sets the delay between the signal on the marker outputs and the start of the signals, expressed in terms of samples. Command `:BB:MCCW:TRIGger:OUTPut:DELay:FIXed ON` can be used to restrict the range of values to the dynamic range, i.e. the range within which a delay of the marker signals can be set without restarting the marker and signal.

#### Parameters:

<Delay>            float  
 Range:            0 to 16777215  
 Increment:        0.001  
 \*RST:            0



**Example:** `BB:MCCW:TRIG:OUTP2:DEL 16`  
sets a delay of 16 samples for the signal on connector MARKER 2.

**Manual operation:** See "[Marker x Delay](#)" on page 365

#### **[:SOURce<hw>]:BB:MCCW:TRIGger:OUTPut<ch>:DELay:MAXimum?**

Queries the maximum marker delay for setting `:BB:MCCW:TRIGger:OUTPut:DELay:FIXed ON`.

**Return values:**

<Maximum> float  
Range: 0 to 16777215  
Increment: 1E-3

**Example:** `BB:MCCW:TRIG:OUTP:DEL:FIX ON`  
restricts the marker signal delay setting range to the dynamic range.  
`BB:MCCW:TRIG:OUTP:DEL:MAX`  
queries the maximum of the dynamic range.  
Response: 2000  
the maximum for the marker delay setting is 2000 samples.

**Usage:** Query only

**Manual operation:** See "[Current Range without Recalculation](#)" on page 366

#### **[:SOURce<hw>]:BB:MCCW:TRIGger:OUTPut<ch>:DELay:MINimum?**

Queries the minimum marker delay for setting `:BB:MCCW:TRIGger:OUTPut:DELay:FIXed ON`.

**Return values:**

<Minimum> float  
Range: 0 to 16777215  
Increment: 1E-3  
\*RST: 0

**Example:** `BB:MCCW:TRIG:OUTP:DEL:FIX ON`  
restricts the marker signal delay setting range to the dynamic range.  
`BB:MCCW:TRIG:OUTP:DEL:MIN`  
queries the minimum of the dynamic range.  
Response: 0  
the minimum for the marker delay setting is 0 samples.

**Usage:** Query only

**Manual operation:** See "[Current Range without Recalculation](#)" on page 366

---

```
[:SOURce<hw>]:BB:MCCW:TRIGger:OUTPut<ch>:MODE <Mode>
```

Defines the signal for the selected marker output.

**Parameters:**

<Mode>

REStart | PULSe | PATTern | RATio

**REStart**

A brief marker signal is generated at the start of the waveform.

**PULSe**

A pulsed marker signal is generated. The pulse frequency (= sample rate/divider) is defined with the

SOUR:BB:MCCW:TRIG:OUTP:PULSe:DIVider command and can be queried with the

SOUR:BB:MCCW:TRIG:OUTP:PULSe:FREQuency? command.

**PATTern**

A marker signal is generated with the aid of a user-definable bit pattern. The bit pattern is entered with the aid of command

SOURce:BB:MCCW:TRIGger:OUTPut:PATTern. The bit pattern is a maximum of 32 bits long.

**RATio**

A regular marker signal corresponding to the Time Off / Time On specifications in the commands

SOURce:BB:MCCW:TRIGger:OUTPut:OFFT and

SOURce:BB:MCCW:TRIGger:OUTPut:ONT is generated.

\*RST: REStart

**Example:**

```
BB:MCCW:TRIG:OUTP2:MODE PULS
```

selects the pulsed marker signal on output MARKER 2.

**Manual operation:** See "[Marker Mode](#)" on page 365

---

```
[:SOURce<hw>]:BB:MCCW:TRIGger:OUTPut<ch>:OFFTime <OffTime>
```

```
[:SOURce<hw>]:BB:MCCW:TRIGger:OUTPut<ch>:ONTime <OnTime>
```

Sets the number of samples in a period (ON time + OFF time) during which the marker signal in setting SOURce:BB:MCCW:TRIGger:OUTPut:MODE RATio on the marker outputs is ON.

**Parameters:**

<OnTime>

integer

Range: 1 to 16777215

\*RST: 1

**Example:**

```
BB:MCCW:TRIG:OUTP2:ONT 20
```

sets an ON time of 20 samples for marker 2.

**Manual operation:** See "[Marker Mode](#)" on page 365

**[[:SOURce<hw>]:BB:MCCW:TRIGger:OUTPut<ch>:PATTern <Pattern>**

Sets the bit pattern used to generate the marker signal in the setting  
 SOURce:BB:MCCW:TRIGger:OUTPut:MODE PATTern 0 is marker off, 1 is marker on.

**Parameters:**

<Pattern> <32 bit pattern>  
 \*RST: 0

**Example:**

BB:MCCW:TRIG:OUTP2:PATT #HE0F52,20  
 sets a bit pattern.  
 BB:MCCW:TRIG:OUTP2:MODE PATT  
 activates the marker signal according to a bit pattern on output  
 MARKER 2.

**Manual operation:** See "[Marker Mode](#)" on page 365

**[[:SOURce<hw>]:BB:MCCW:TRIGger:OUTPut<ch>:PULSe:DIVider <Divider>**

Sets the divider for Pulse marker mode (SOUR:BB:MCCW:TRIG:OUTP:MODE PULSe).  
 The resulting pulse frequency is derived by dividing the symbol rate by the divider.

**Parameters:**

<Divider> integer  
 Range: 2 to 1024  
 \*RST: 2

**Example:**

BB:MCCW:TRIG:OUTP2:PULS:DIV 2  
 sets the divider for the marker signal on output MARKER 2 to  
 the value 2.  
 BB:MCCW:TRIG:OUTP2:FREQ?  
 queries the resulting pulse frequency of the marker signal  
 Response: 66 000  
 the resulting pulse frequency is 66 kHz.

**Manual operation:** See "[Marker Mode](#)" on page 365

**[[:SOURce<hw>]:BB:MCCW:TRIGger:OUTPut<ch>:PULSe:FREQuency?**

Queries the pulse frequency of the pulsed marker signal in the setting  
 SOUR:BB:MCCW:TRIG:OUTP:MODE PULS. The pulse frequency is derived by dividing  
 the symbol rate by the divider. The divider is defined with command  
 SOUR:BB:MCCW:TRIG:OUTP:PULS:DIV.

**Return values:**

<Frequency> float  
 Increment: 1E-3

**Example:** `BB:MCCW:TRIG:OUTP2:PULS:DIV 4`  
 sets the divider for the marker signal on output MARKER 2 to the value 4.  
`BB:MCCW:TRIG:OUTP2:MODE PULS`  
 enables the pulsed marker signal  
`BB:MCCW:TRIG:OUTP2:PULS:FREQ?`  
 queries the pulse frequency for the marker signal.  
 Response: "33 000"  
 the resulting pulse frequency is 33 kHz.

**Usage:** Query only

**Manual operation:** See "[Marker Mode](#)" on page 365

### Clock Settings

[\[:SOURce<hw>\]:BB:MCCW:CLOCK:MODE](#)..... 620  
[\[:SOURce<hw>\]:BB:MCCW:CLOCK:MULTiplier](#)..... 620  
[\[:SOURce<hw>\]:BB:MCCW:CLOCK:SOURce](#)..... 621

---

#### **[:SOURce<hw>]:BB:MCCW:CLOCK:MODE <Mode>**

Sets the type of externally supplied clock (`:BB:MCCW:CLOCK:SOURce EXTERNAL`). When `MSAMple` is used, a multiple of the sample clock is supplied via the `CLOCK` connector and the sample clock is derived internally from this. The multiplier is entered with the command `BB:MCCW:CLOCK:MULTiplier`.

For two path instruments, the only numerical suffix allowed for `SOURce` is 1, since the external clock source is permanently allocated to path A.

**Parameters:**

<Mode>                   SAMPLE | MSAMple  
 \*RST:                   SAMPLE

**Example:** `BB:MCCW:CLOC:MODE SAMP`  
 selects clock type "Sample", i.e. the supplied clock is a sample clock.

**Manual operation:** See "[Clock Mode](#)" on page 366

---

#### **[:SOURce<hw>]:BB:MCCW:CLOCK:MULTiplier <Multiplier>**

Specifies the multiplier for clock type Multiple Samples (`:BB:MCCW:CLOCK:MODE MSAM`) in the case of an external clock source.

For two-path instruments, the only numerical suffix allowed for `SOURce` is 1, since the external clock source is permanently allocated to path A.

**Parameters:**

<Multiplier>           integer  
 Range:                 1 to 64  
 \*RST:                 4

**Example:** `BB:MCCW:CLOC:SOUR EXT`  
 selects the external clock source. The clock is supplied via the CLOCK connector.  
`BB:MCCW:CLOC:MODE MSAM`  
 selects clock type "Multiple Samples", i.e. the supplied clock has a rate which is a multiple of the sample rate.  
`BB:MCCW:CLOC:MULT 12`  
 the multiplier for the external clock rate is 12.

**Manual operation:** See "[Clock Multiplier](#)" on page 366

**[:SOURce<hw>]:BB:MCCW:CLOCK:SOURce <Source>**

Selects the source for the digital modulation clock.

For two-path instruments, selecting `EXTernal` is only possible for path A, since the external clock source is permanently allocated to path A.

**Parameters:**

<Source>            `INTernal` | `EXTernal` | `AINternal`

**INTernal**

The internal clock reference is used.

**EXTernal**

The external clock reference is supplied to the CLOCK connector.

\*RST:            `INTernal`

**Example:** `BB:MCCW:CLOC:SOUR EXT`  
 selects an external clock reference. The clock is supplied via the CLOCK connector.

**Manual operation:** See "[Clock Source](#)" on page 366

### 7.15.2.7 SOURce:BB:MEASurement Subsystem

This subsystem contains the commands for measuring the level values of the digital baseband signal.



Monitoring the measurement of the digital I/Q baseband signal requires the baseboard version "DacBoard 1141.8190.02" or higher. Up to baseboard version DacBoard 1141.8090.xx only the calculated signal levels are provided.

The currently equipped DacBoard is listed in the dialog "Setup > System > Hardware Config, section Baseband Assembly" (see [Chapter 5.2.3.3, "Hardware Config"](#), on page 142).

**[:SOURce<hw>]:BB:MEASurement:CFACTOR?**

Queries the crest factor of the baseband signal during power measurement.

**Return values:**

<CFactor> float  
 Range: 0 to 100  
 Increment: 0.01  
 \*RST: 0  
 Default unit: dB

**Example:**

BB:MEAS:CFAC?  
 Queries the measured crest factor of the baseband signal.

**Usage:**

Query only

**Manual operation:**

See "[Crest Factor - Digital Impairments - Measurement](#)" on page 235

**[[:SOURce<hw>]:BB:MEASurement:DURation <Duration>**

Sets the time for the measurement of the digital I/Q baseband signal in the range of 1 s ... 3 h.

**Parameters:**

<Duration> hh:mm:ss  
 Range: 1s to 3h  
 \*RST: 1s

**Example:**

BB:MEAS:DUR "00:15:30"  
 sets the measurement duration to 15 minutes and 30 seconds.

**Manual operation:**

See "[Duration - Digital Impairments - Measurement](#)" on page 234

**[[:SOURce<hw>]:BB:MEASurement:POWER:PEAK?**

Queries the peak power of the baseband signal relative to full scale of 0.5 V (in terms of dB full scale) during measurement.

**Return values:**

<Peak> float  
 Range: -10 to 10  
 Increment: 0.01  
 \*RST: 0  
 Default unit: dBfs

**Example:**

BB:MEAS:POW:PEAK?  
 Queries the peak power of the baseband signal.

**Usage:**

Query only

**Manual operation:**

See "[Peak Power - Digital Impairments - Measurement](#)" on page 235

**[[:SOURce<hw>]:BB:MEASurement:POWER:RMS?**

Queries the power of the baseband signal relative to full scale of 0.5 V (in terms of dB full scale) during measurement.

**Return values:**

<Rms> float  
 Range: -100 to 10  
 Increment: 0.01  
 \*RST: 0  
 Default unit: dBfs

**Example:**

BB:MEAS:POW:RMS?  
 Queries the power of the baseband signal.

**Usage:** Query only

**Manual operation:** See "[Power - Digital Impairments - Measurement](#)" on page 235

**[[:SOURce<hw>]:BB:MEASurement:RTIME?**

Queries the remaining time until the measurement of the digital I/Q baseband signal is completed.

**Return values:**

<RTIME> string | hh:mm:ss

**Example:**

BB:MEAS:RTIM?  
 Queries the remaining measurement duration.

**Usage:** Query only

**Manual operation:** See "[Remaining Time - Digital Impairments - Measurement](#)" on page 234

**[[:SOURce<hw>]:BB:MEASurement:SOURce <Source>**

Selects the signal source for the measurement. The power and crest factor can be retrieved either from the interference-free digital I/Q baseband signal or the signal superimposed by the noise generator AWGN.

**Parameters:**

<Source> BB | BAWGn  
**BB**  
 (Baseband Signal without AWGN)  
 Selects the measurement of the interference-free baseband signal.  
**BAWGn**  
 (Baseband with AWGN)  
 Selects the measurement of the baseband signal after an AWGN noise signal is added.  
 \*RST: BB

**Example:** `BB:MEAS:SOURC BAWG`  
selects the measurement of the digital baseband signal interfered with a noise signal.

**Manual operation:** See ["Signal Source - Digital Impairments - Measurement"](#) on page 234

#### **[:SOURce<hw>]:BB:MEASurement[:STATe] <State>**

Activates the measurement of the digital I/Q baseband signal. When activated, information on the peak power, power and crest factor are indicated. Additionally the duration of the measurement can be set.

**Parameters:**

<State> 0 | 1 | OFF | ON  
\*RST: 0

**Example:** `BB:MEAS:STAT ON`  
starts measuring the real power values of the digital I/Q baseband signal.

**Manual operation:** See ["State - Digital Impairments - Measurement"](#) on page 234

#### **[:SOURce<hw>]:BB:MFPCorrection?**

Queries the MIMO fading power correction, that is the relative power offset of the selected path compared to the power of the other path.

The resulting power level of the selected path is calculated as the difference between the RF level and the MIMO fading power correction value.

**Return values:**

<MfpCorrection> float  
Range: -1000 to 1000  
Increment: 0.01  
\*RST: 0



**Example:**

```
SOURce1:FSIMulator:ROUTE FA1A2BFB1A2BM2
SOURce1:FSIMulator:MIMO:TAP1:MATRIX:ROW1:
COLumn1:MAGNitude 0.9
SOURce1:FSIMulator:MIMO:TAP1:MATRIX:ROW2:
COLumn2:MAGNitude 1
SOURce1:FSIMulator:MIMO:TAP1:MATRIX:ROW3:
COLumn3:MAGNitude 1
SOURce1:FSIMulator:MIMO:TAP1:MATRIX:ROW4:
COLumn4:MAGNitude 1
SOURce1:FSIMulator:MIMO:TAP1:MATRIX:ACCEPT
SOURce1:BB:MFPCorrection?
Response: 0.23
SOURce2:BB:MFPCorrection?
Response: 0
The signal of path B is with 0.23 dB stronger than the signal of
path A.
```

**Usage:** Query only

**Manual operation:** See "[MIMO Fading Power Correction - Digital Impairments - Measurement](#)" on page 235

#### 7.15.2.8 SOURce:BB:POWER Subsystem

This subsystem contains the commands for retrieving the level values of the digital baseband signal.

---

##### [SOURce<hw>]:BB:CFACtor?

This command queries the crest factor of the baseband signal.

**Return values:**

```
<CFactor>          float
                    Range:    0 to 100
                    Increment: 0.01
                    *RST:     0
                    Default unit: dB
```

**Example:**

```
BB:CFAC
queries the crest factor of the baseband signal.
```

**Usage:** Query only

**Manual operation:** See "[Crest Factor - Digital Impairments](#)" on page 233

---

##### [SOURce<hw>]:BB:POWER:PEAK?

This command queries the peak power of the baseband signal relative to full scale of 0.5 V (in terms of dB full scale).

**Return values:**

<Peak> float  
 Range: -145 to 30  
 Increment: 0.01  
 \*RST: 0  
 Default unit: dBfs

**Example:**

BB:POW:PEAK  
 queries the peak power of the baseband signal.

**Usage:** Query only

**Manual operation:** See "[Peak Power - Digital Impairments](#)" on page 233

**[[:SOURce<hw>]:BB:POWER:RMS?**

This command queries the power of the baseband signal relative to full scale of 0.5V (in terms of dB full scale).

**Return values:**

<Rms> float  
 Range: -145 to 30  
 Increment: 0.01  
 \*RST: 0  
 Default unit: dBfs

**Example:**

BB:POW:RMS  
 queries the power of the baseband signal.

**Usage:** Query only

**Manual operation:** See "[Power - Digital Impairments](#)" on page 233

**7.15.2.9 SOURce:BB:PROGress Subsystem General Commands**

In the R&S AMU, some calculation processes may take longer time. While operating the instrument manually, you can observe the status of an initiated process by the busy indicator. The following commands fulfill the same task in the remote control operation.

**Example: Querying the status of the Create Waveform file process**

The following is an example on how to use these commands to retrieve information about how many percent of the initiated process are completed.

```
:SOURce1:BB:EUTRa:SETTing:TMOD:DL "E-TM1_1__15MHz"
:SOURce1:BB:EUTRa:SLENgth 100
:SOURce1:BB:PROGress:MCODer?
// 100 (task compleated)
:SOURce1:BB:EUTRa:STATe ON
:BB:PROGress:MCODer?
// 67 (task in progress)
:SOURce1:BB:EUTRa:WAVEform:CREate
```

```

:SOURce1:BB:PROGress:MCODer?
// 25 (task in progress)
// :SOURce1:BB:PROGress:MCODer:DM:FILTer?
// 100

[:SOURce<hw>]:BB:PROGress:MCODer?.....627
[:SOURce<hw>]:BB:PROGress:MCODer:ARBitrary:MCARrier?.....627
[:SOURce<hw>]:BB:PROGress:MCODer:ARBitrary:WSEGment?.....627
[:SOURce<hw>]:BB:PROGress:MCODer:DM:FILTer?..... 627

```

---

**[:SOURce<hw>]:BB:PROGress:MCODer?**  
**[:SOURce<hw>]:BB:PROGress:MCODer:ARBitrary:MCARrier?**  
**[:SOURce<hw>]:BB:PROGress:MCODer:ARBitrary:WSEGment?**

Queries the status of an initiated process, like for example the calculation of a signal in accordance to a digital standard, or the calculation of a multi carrier or multi segment waveform file.

**Return values:**

<WSegment>           integer  
                           Indicates the task progress in percent  
                           Range:     0 to 100  
                           \*RST:     100

**Example:**            see [Example "Querying the status of the Create Waveform file process"](#) on page 626

**Usage:**             Query only

---

**[:SOURce<hw>]:BB:PROGress:MCODer:DM:FILTer?**

Queries the status of an applied offline filtering, like for example during the calculation of a waveform and a multi carrier waveform file.

**Return values:**

<Filter>               integer  
                           Indicates the task progress in percent  
                           Range:     0 to 100  
                           \*RST:     100

**Example:**            see [Example "Querying the status of the Create Waveform file process"](#) on page 626

**Usage:**             Query only

### 7.15.3 SOURce:BBIN Subsystem

The SOURce:BBIN subsystem contains the commands for setting the external digital and analog baseband signals.

The external baseband signal A can be routed to path A, path B, or both paths. The external baseband signal B can be routed to path B only.

<a href="#">[:SOURce&lt;hw&gt;]:BBIN:ALEVel:EXECute</a> .....	628
<a href="#">[:SOURce&lt;hw&gt;]:BBIN:CDEVice?</a> .....	628
<a href="#">[:SOURce&lt;hw&gt;]:BBIN:CFACtor</a> .....	629
<a href="#">[:SOURce&lt;hw&gt;]:BBIN:DIGital:ASETting:STATe</a> .....	629
<a href="#">[:SOURce&lt;hw&gt;]:BBIN:FOFFset</a> .....	629
<a href="#">[:SOURce&lt;hw&gt;]:BBIN:GIMBalance</a> .....	630
<a href="#">[:SOURce&lt;hw&gt;]:BBIN:IQSWap[:STATe]</a> .....	630
<a href="#">[:SOURce&lt;hw&gt;]:BBIN:MODE</a> .....	630
<a href="#">[:SOURce&lt;hw&gt;]:BBIN:MPERiod</a> .....	631
<a href="#">[:SOURce&lt;hw&gt;]:BBIN:OFFSet:I</a> .....	631
<a href="#">[:SOURce&lt;hw&gt;]:BBIN:OFFSet:Q</a> .....	631
<a href="#">[:SOURce&lt;hw&gt;]:BBIN:OLOad:HOLD:RESet</a> .....	631
<a href="#">[:SOURce&lt;hw&gt;]:BBIN:OLOad:HOLD:STATe?</a> .....	632
<a href="#">[:SOURce&lt;hw&gt;]:BBIN:OLOad:STATe?</a> .....	632
<a href="#">[:SOURce&lt;hw&gt;]:BBIN:PGain</a> .....	632
<a href="#">[:SOURce&lt;hw&gt;]:BBIN:POWer:PEAK</a> .....	633
<a href="#">[:SOURce&lt;hw&gt;]:BBIN:POWer:RMS?</a> .....	633
<a href="#">[:SOURce&lt;hw&gt;]:BBIN:ROUte</a> .....	633
<a href="#">[:SOURce&lt;hw&gt;]:BBIN:SKEW</a> .....	634
<a href="#">[:SOURce&lt;hw&gt;]:BBIN:SRATe[:ACTual]?</a> .....	634
<a href="#">[:SOURce&lt;hw&gt;]:BBIN:SRATe:FIFO[:STATus]?</a> .....	635
<a href="#">[:SOURce&lt;hw&gt;]:BBIN:SRATe:SOURce</a> .....	635
<a href="#">[:SOURce&lt;hw&gt;]:BBIN:STATe</a> .....	635

---

### **[\[:SOURce<hw>\]:BBIN:ALEVel:EXECute](#)**

This command starts measuring the input signal. The measurement estimates the crest factor and the peak power.

**Example:**                   BBIN:ALEV:EXEC  
starts measuring the input signal.

**Usage:**                    Event

**Manual operation:**    See "[Auto Level Set](#)" on page 374

---

### **[\[:SOURce<hw>\]:BBIN:CDEVice?](#)**

Digital Input only.

Indicates the ID of an externally connected R&S Instrument or R&S Device.

**Return values:**  
<CDevice>                string

**Example:**                BBIN:CDEV  
queries the connected device ID.

**Usage:**                   Query only

**Manual operation:**    See "[Connected Device](#)" on page 376

---

**[[:SOURce<hw>]:BBIN:CFACtor <CFactor>**

This command enters the crest factor of the external baseband signal.

**Parameters:**

<CFactor> float  
 Range: 0 to 30  
 Increment: 0.01  
 \*RST: 0  
 Default unit: dB

**Example:** BBIN:CFAC 10  
 enters a crest factor of 10 dB for the external baseband signal.

**Manual operation:** See "[Crest Factor](#)" on page 374

---

**[[:SOURce<hw>]:BBIN:DIGital:ASETting:STATe <State>**

Activates automatic adjustment of the baseband input signal.

The R&S AMU receives peak level, level and crest factor values directly from the connected transmitter and recognizes changes automatically.

**Parameters:**

<State> 0 | 1 | OFF | ON  
 \*RST: 0

**Example:** BBIN:DIG:ASET:STAT ON  
 switches on automatic adjustment of the baseband input signal.

**Manual operation:** See "[DIG IQ Auto Setting](#)" on page 373

---

**[[:SOURce<hw>]:BBIN:FOFFset <FOffset>**

Enters the frequency offset for the external baseband signal.

The complex I/Q bandwidth of the shifted useful signal must not exceed the total available baseband bandwidth (see data sheet).

**Parameters:**

<FOffset> float  
 Range: -40E6 to 40E6  
 Increment: 0.01  
 \*RST: 0  
 Default unit: Hz

**Example:** BBIN:FOFF 2 MHz  
 sets a frequency offset of 2 MHz.

**Manual operation:** See "[Frequency Offset](#)" on page 376

---

**[[:SOURce<hw>]:BBIN:GIMBalance <GImbalance>**

This command enters a gain to the Q component of the external baseband signal.

**Parameters:**

<GImbalance> float  
Range: -3 to 3  
Increment: 0.001  
\*RST: 0  
Default unit: dB

**Example:**

BBIN:GIMB -1.0dB  
amplifies the Q component of the external input signal with -1.0 dB.

**Manual operation:** See "[Gain Imbalance \(Q versus I\)](#)" on page 375

---

**[[:SOURce<hw>]:BBIN:IQSWap[:STATe] <State>**

This command swaps the I and Q channel if set to ON.

**Parameters:**

<State> 0 | 1 | OFF | ON  
\*RST: 0

**Example:**

BBIN:IQSW ON  
swaps the I and Q channel of the external baseband signal.

**Manual operation:** See "[I/Q-Swap](#)" on page 372

---

**[[:SOURce<hw>]:BBIN:MODE <Mode>**

This command selects the external input signal mode for the "Baseband In" block.

**Parameters:**

<Mode> ANALog | DIGital

**ANALog**

The external analog baseband signal is supplied via the inputs **I** and **Q**.

**DIGital**

The external digital baseband signal is fed into the signal path via the "Digital Input" connector. The internal signal processing is based on a sample rate of 100 MHz. Input signals with a sample rate less than 100 MHz are upsampled. The sample rate can be estimated or defined by the user in the appropriate entry fields.

**Note:** This item is available only with BBinS Revision 05.02 or higher and BBinR Revision 02.06 or higher (see [Chapter 5.2.3.3, "Hardware Config"](#), on page 142).

\*RST: ANALog

**Example:** `BBIN:SOUR ANAL`  
selects an external analog signal as the input signal. The signal must be applied at the inputs I and Q.

**Manual operation:** See "[Mode](#)" on page 371

**[:SOURce<hw>]:BBIN:MPERiod <MPeriod>**

Sets the recording duration for measuring the baseband input signal by Auto Level Set.

**Parameters:**

<MPeriod> integer  
Range: 1 to 32  
\*RST: 2  
Default unit: s

**Example:** `BBIN:MPER 4s`  
sets the recording duration for Auto Level Set to 4 seconds.

**Manual operation:** See "[Measurement Period](#)" on page 374

**[:SOURce<hw>]:BBIN:OFFSet:I <I>**  
**[:SOURce<hw>]:BBIN:OFFSet:Q <Q>**

This command enters a DC offset to the Q component of the external baseband signal.

**Parameters:**

<Q> float  
Range: -10 to 10  
Increment: 0.001  
\*RST: 0  
Default unit: %FS

**Example:** `BBIN:OFFS:Q -0.1PCT`  
sets -0.1 %FS DC offset to the Q component of the external input signal.

**Manual operation:** See "[Q Offset](#)" on page 375

**[:SOURce<hw>]:BBIN:OLOad:HOLD:RESet**

This command executes a reset of the Overload Hold State and LED.

**Example:** `BBIN:MODE DIG`  
selects the digital baseband input mode.  
`BBIN:OLO:HOLD:RES`  
resets the overload hold state.

**Usage:** Event

**[[:SOURce<hw>]:BBIN:OLOad:HOLD:STATe?**

This command queries an overload since the last reset for evaluating the measurement. The Overload Hold state can be reset via the "Reset" command, or is reset automatically by starting a new measurement ("Auto Level Set") or by setting new values (Crest Factor, Peak Level, Level).

**Return values:**

<State>            0 | 1 | OFF | ON  
 \*RST:            0

**Example:**

BBIN:MODE DIG  
 selects the digital baseband input mode.  
 BBIN:OLO:HOLD:STAT?  
 queries the overload state.  
 Response: 0  
 the AC/DC converter has not been overloaded.

**Usage:**            Query only

**Manual operation:** See "[Overload Hold](#)" on page 376

**[[:SOURce<hw>]:BBIN:OLOad:STATe?**

This command queries the current overload state of the A/D converter.

**Return values:**

<State>            0 | 1 | OFF | ON  
 \*RST:            0

**Example:**

BBIN:MODE DIG  
 selects the digital baseband input mode.  
 BBIN:OLO:STAT?  
 queries the overload state.  
 Response: 0  
 The AC/DC converter is not overloaded.

**Usage:**            Query only

**Manual operation:** See "[Overload](#)" on page 376

**[[:SOURce<hw>]:BBIN:PGain <PGain>**

This command enters the relative gain for the external baseband signal compared with the signals of the other baseband sources. The actual gain of the different baseband signals depends not only on the path gain setting but also on the signal characteristics such as the crest factor and on the number of used sources, used and on the total RF output power. The gain affects the signal on the "Baseband" In block output.



**Parameters:**

<PGain> float  
 Range: -50 to 50  
 Increment: 1E-3  
 \*RST: 0  
 Default unit: dB

**Example:**

BBIN:PGA 3dB  
 sets the relative gain of 3 dB for the external baseband signal.

**Manual operation:** See "[Path Gain](#)" on page 377

**[[:SOURce<hw>]:BBIN:POWER:PEAK <Peak>**

This command enters the peak level of the external baseband signal relative to full scale of 0.5 V (in terms of dB full scale).

**Parameters:**

<Peak> float  
 Range: -60 to 3.02  
 Increment: 0.01  
 \*RST: 0  
 Default unit: dBfs

**Example:**

BBIN:POW:PEAK -2  
 enters the peak level of -2 dBfs.

**Manual operation:** See "[Peak Level](#)" on page 374

**[[:SOURce<hw>]:BBIN:POWER:RMS?**

This command queries the rms level of the external digital baseband signal.

**Return values:**

<Rms> float  
 Range: -100 to 10  
 Increment: 0.01  
 \*RST: 0

**Example:**

BBIN:POW:RMS  
 queries the estimated rms level.

**Usage:**

Query only

**Manual operation:** See "[Level](#)" on page 374

**[[:SOURce<hw>]:BBIN:ROUTE <Route>**

Selects the signal route for the external baseband signal of a two-path instrument.

**Parameters:**

&lt;Route&gt;

A | B | AB

**A**

The external baseband signal is introduced into path A. The signals are summed if necessary.

**B**

The external baseband signal is introduced into path B. The signals are summed if necessary.

**AB**

The external baseband signal is introduced into path A and path B. The signals are summed if necessary.

\*RST: A

**Example:**

BBIN:ROUT A

The external baseband signal is introduced into path A.

**Manual operation:** See "[Signal Routing](#)" on page 377

**[[:SOURce<hw>]:BBIN:SKEW <Skew>**

This command determines the delay between Q and I channel. Positive values represent a delay for Q versus I.

**Parameters:**

&lt;Skew&gt;

float

Range: -1E-9 to 1E-9

Increment: 1E-12

\*RST: 0

Default unit: s

**Example:**

BBIN:SKEW -23PS

enters a delay between Q and I channel of 23 picoseconds.

**Manual operation:** See "[I/Q-Skew \(Q Delay\)](#)" on page 375

**[[:SOURce<hw>]:BBIN:SRATe[:ACTual]?**

Queries the sample rate of the external digital baseband signal.

**Note:** The maximum value is 90 MHz with BBinR Revision 02.xx and 100 MHz with BBinR Revision 03.00 or higher.

**Return values:**

&lt;Actual&gt;

float

**Example:**

BBIN:SRAT?

queries the sample rate value of the external digital baseband signal.

**Usage:**

Query only

**Manual operation:** See "[Sample Rate Value](#)" on page 373

**[[:SOURce<hw>]:BBIN:SRATe:FIFO[:STATus]?**

This command indicates the state of the signal transmission.

**Return values:**

<Status> OK | OFLow | URUN

**OK**

Resampling is working properly.

**OFL = Overflow**

The external sample rate frequency is too high which causes an overflow in signal transmission.

**URUN = Underrun**

The external sample rate frequency is too low which causes an underrun in signal transmission.

\*RST: OK

**Example:**

BBIN:SRAT:FIFO:STAT

queries the FIFO Status of the sample rate.

**Usage:**

Query only

**Manual operation:** See "[FIFO Status](#)" on page 373

**[[:SOURce<hw>]:BBIN:SRATe:SOURce <Source>**

This command queries the source for estimating the sample rate of the digital input signal or defining it by the user.

**Note:** With a connected **R&S EX-IQ-Box** either the internal clock source (User defined) or an external clock (Digital I/Q In) can be selected in the settings dialog of the R&S EX-IQ-Box. Therefore, the sample rate source is only indicated in this field.

**Parameters:**

<Source> USER | DIN

\*RST: USER

**Example:**

BBIN:SRAT:SOUR

queries the sample rate mode of the external digital baseband signal.

**Manual operation:** See "[Sample Rate Source](#)" on page 372

**[[:SOURce<hw>]:BBIN:STATe <State>**

This command switches the feeding of an external analog signal into the signal path on/off.

**Parameters:**

<State> 0 | 1 | OFF | ON

\*RST: 0

- Example:** `BBIN:SOUR ANAL`  
selects an external analog signal as the input signal. The signal must be applied at the inputs I and Q.
- `BBIN:STAT ON`  
switches on the Baseband In block. The external analog signal is A/D-converted and fed into the digital signal.
- Manual operation:** See "State" on page 371

#### 7.15.4 SOURce:INPut Subsystem

The `SOURce:INPut` subsystem contains the commands for configuring the inputs for trigger, data and control signals. A common trigger threshold and input impedance is effective for all trigger and control signal inputs.

In case of a two-path instrument, this affects both paths.

The settings influence the digital modulations, the generation of waveforms or multicarrier signals, and all digital standards. Irrespective of this, a common threshold and input impedance is effective for the serial and parallel data input (Path A only). These data sources are available for digital modulation ("Custom Digital Modulation").

<code>[:SOURce]:INPut:DATA:IMPedance</code> .....	636
<code>[:SOURce]:INPut:DATA:THReshold</code> .....	636
<code>[:SOURce]:INPut:TRIGger:BBANd:SLOPe</code> .....	637
<code>[:SOURce]:INPut:TRIGger:IMPedance</code> .....	637
<code>[:SOURce]:INPut:TRIGger:LEVel</code> .....	638
<code>[:SOURce]:INPut:TRIGger:SLOPe</code> .....	638

---

#### `[:SOURce]:INPut:DATA:IMPedance <Impedance>`

Sets the impedance of all data inputs.

The setting affects the serial data input DATA at the front of the instrument and the serial data inputs DATA at the AUX I/O interface at the rear of the instrument.

**Parameters:**

<Impedance>            G50 | G1K  
                          \*RST:        G1K

- Example:** `INP:DATA:IMP G50`  
all data inputs are set to 50 ohm to ground.

- Manual operation:** See "Impedance Data Input" on page 149

---

#### `[:SOURce]:INPut:DATA:THReshold <Threshold>`

Sets the high/low threshold of the data inputs in the baseband section. In the case of positive polarity, this threshold determines the point as of which a signal is high (active) or low (inactive).

The setting affects the serial data input DATA at the front of the instrument and the serial data inputs DATA at the AUX I/O interface at the rear of the instrument.

**Parameters:**

<Threshold> float  
 Range: 0.01 to 2  
 Increment: 0.01  
 \*RST: 1  
 Default unit: V

**Example:**

INP:DATA:THR 1 V  
 a high/low threshold of 1 volt is set at all data inputs of the baseband section. The signal is high (active) for a signal voltage of 1 volt and higher.

**Manual operation:** See ["Threshold Data Input"](#) on page 149

**[[:SOURce]:INPut:TRIGger:BBANd:SLOPe <Slope>**

Sets the active slope of an externally applied trigger signal at the TRIGGER connectors. The setting is effective for both connectors at the same time.

**Parameters:**

<Slope> NEGative | POSitive  
 \*RST: POSitive

**Example:**

INP:TRIG:BBAN:SLOP NEG  
 activates the falling slope of the external trigger signal at the TRIGGER connectors.

**Manual operation:** See ["Baseband Trigger Input Slope"](#) on page 150

**[[:SOURce]:INPut:TRIGger:IMPedance <Impedance>**

The command sets the impedance of the trigger and control signal inputs and affects:

- TRIGGER inputs
- CLOCK inputs
- CW, BURST, and LEV\_ATT inputs (AUX I/O connector)

**Parameters:**

<Impedance> G50 | G1K  
**G1K**  
 1 kOhm to ground  
**G50**  
 50 Ohm to ground  
 \*RST: G1K

**Example:**

INP:TRIG:IMP G50  
 all trigger and control signal inputs are set to 50 ohm to ground. This setting is recommended in the case of high clock rates.

**Manual operation:** See ["Impedance Trigger/Control Input"](#) on page 149

**[[:SOURce]:INPut:TRIGger:LEVel <Level>**

Sets the high/low threshold of the trigger and control signal inputs in the baseband section. In the case of positive polarity, this threshold determines the point as of which a signal is high (active) or low (inactive).

The command affects:

- TRIGGER inputs
- CLOCK inputs
- CW, BURST, and LEV\_ATT inputs (AUX I/O connector)

**Parameters:**

<Level> float  
 Range: 0.01 to 2  
 Increment: 0.01  
 \*RST: 1  
 Default unit: V

**Example:**

INP:TRIG:LEV 1 V  
 a high/low threshold of 1 volt is set at all trigger and control signal inputs of the baseband section. In the case of positive polarity, the signal is high (active) for a signal voltage of 1 volt and higher.

**Manual operation:** See ["Threshold Trigger/Control Input"](#) on page 149

**[[:SOURce]:INPut:TRIGger:SLOPe <Slope>**

Sets the polarity of the active slope of an externally applied trigger signal at the trigger input (BNC connector at the rear of the instrument).

For two-path instruments, the external trigger for path B is applied at the INST TRIG pin at the AUX I/O interface.

**Parameters:**

<Slope> NEGative | POSitive  
 \*RST: POSitive

**Example:**

INP:TRIG:SLOP NEG  
 activates the falling slope of the external trigger signal at the trigger input.

**Manual operation:** See ["Instrument Trigger Input Slope"](#) on page 150

## 7.15.5 SOURce:IQ:OUTPut Subsystem

### 7.15.5.1 SOURce:IQ:OUTPut Subsystem - I/Q Output

This subsystem contains the commands for switching on/off the I/Q output function blocks as well as for selecting level settings displayed in the status bar.

For information about the required options, see [Chapter 5.5, "Output of Digital and Analog Baseband Signal - I/Q Out"](#), on page 208.

:OUTPut:IQ:ALL[:STATe].....	639
[:SOURce<hw>]:IQ:OUTPut:DISPlay.....	639
[:SOURce<hw>]:IQ:OUTPut:DISPlay:AInFOrmation.....	640
[:SOURce<hw>]:IQ:OUTPut:POWer:VIA.....	640
[:SOURce<hw>]:IQ:OUTPut:STATe.....	641
[:SOURce<hw>]:IQ:OUTPut:SWAP[:STATe].....	641

---

### :OUTPut:IQ:ALL[:STATe] <State>

Accordingly to the BASEBD ON/OFF key, the command switches the I/Q output signals on and off.

In the two-path mode, the command `OUTP:IQ:ALL:STAT OFF` switches all outputs off. A subsequent command `OUTP:IQ:ALL:STAT ON` restores the status that was active before the last switch-off. "I/Q OUT OFF" is displayed in the status bar

#### Parameters:

<State>                    0 | 1 | OFF | ON  
 \*RST:                    0

#### Example:

`OUTP:IQ:ALL ON`  
 the I/Q output signals, which have been active before the last switch off are activated again (path A and path B).

#### Options:

R&S AMU-B13; SOURce2 only with a second option R&S AMU-B13 and second options R&S AMU-B16 and -B18.

**Manual operation:** See "[BASEBD ON/OFF](#)" on page 209

---

### [:SOURce<hw>]:IQ:OUTPut:DISPlay <Display>

This command displays the selected I/Q output type in the status bar.

#### Parameters:

<Display>                    ANALog | DIGital

#### ANALog

The I/Q-signal components are output analog. Single ended or differential analog I/Q output is to be selected in the analog I/Q output settings menu.

#### DIGital

The I/Q-signal components are output digital.

\*RST:                    ANALog

#### Example:

`IQ:OUTP:DISP ANAL`  
 the I/Q-signal components of path A are output analog.

#### Options:

R&S AMU-B13 and -B16

**Manual operation:** See "[Display I/Q-Output](#)" on page 210

---

**[[:SOURce<hw>]:IQ:OUTPut:DISPlay:AINFormation <AInformation>**

This command displays auxiliary information for the corresponding path in the status bar. The parameters insertion loss or crest factor can be indicated to help the user setting up a fading scenario.

After selecting the parameters the status line of the I/Q Out block displays the appropriate information for the selected signal path.

**Parameters:**

&lt;AInformation&gt;

DISabled | CFS | CFSN | ILOSs

**DISabled**

Indicates no auxiliary parameters in the status bar.

**CFS**

Indicates the crest factor of the output signal without noise.

Crestfactor(S)=PEP(S)/Level(S)

**CFSN**

Indicates the ratio of the peak value of the signal plus noise, to the RMS level of the signal without noise.

CrestFactor((S+N)/S)=(PEP(S+N))/Level(S)

**ILOSs**

Indicates the decrease in signal power of the baseband input signal resulting from the insertion loss of the instrument. Insertion loss is defined as the ratio of the input signal level to the output signal level and is expressed in dB.

**Tip:** To enable the display settings both, baseband input and I/Q output display must be operated in the same mode, either in digital mode or analog mode.

\*RST: DISabled

**Example:**

IQ:OUTP:DISP ANAL

the I/Q-signal components of path A are output analog.

**Options:**

R&amp;S AMU-B13 and -B16

**Manual operation:**See "[Auxiliary Information](#)" on page 211

---

**[[:SOURce<hw>]:IQ:OUTPut:POWer:VIA <Via>**

Activates the selected I/Q output level entry fields of the currently selected signal path in the status bar.

Either the PEP or the Level entry value can be selected.

- For **analog** signal output the signal level (PEP/Level) can be set in volts (V) or millivolts (mV), or in decibel referenced to milliwatt (dBm). dBm can only be selected if the load type of the analog output is set to 50 Ω (single ended) or to 100 Ω (differential).
- For **digital** signal output the signal level (PEP/Level) can be set in full scale ratio (FS) or in decibel referenced to full scale (dBFS).



**Parameters:**

&lt;Via&gt; PEP | LEVel

**PEP**

The signal level is expressed in terms of a peak envelope power value (PEP). The level entry fields and the corresponding units are displayed in the status bar.

If noise is added to the baseband signal, the PEP value is referred to the sum, signal and noise, shown in the status bar of the display by the symbol "PEP S+N".

**LEVel**

The signal level is expressed in terms of a rms value. The level entry field and the corresponding units are displayed in the status bar.

The level always refers to the RMS value of the output signal without noise, even if the AWGN generator is activated.

\*RST: PEP

**Example:**

IQ:OUTP:POW:VIA PEP

the I/Q-signal level is set via PEP for the signal of path A.

**Manual operation:** See ["Set Level Via"](#) on page 211

[:SOURce&lt;hw&gt;]:IQ:OUTPut:STATe &lt;State&gt;

The command activates (ON) and deactivates (OFF) the output signals at the selected I/Q OUT function block.

**Parameters:**

&lt;State&gt; 0 | 1 | OFF | ON

\*RST: 0

**Example:**

:IQ:OUTP:STAT ON

the I/Q output components of the baseband signal path A are activated.

**Options:**

R&S AMU-B13; SOURce2 only with a second option R&S AMU-B13 and second options R&S AMU-B16 and -B18.

**Manual operation:** See ["I/Q Out ON"](#) on page 210

[:SOURce&lt;hw&gt;]:IQ:OUTPut:SWAP[:STATe] &lt;State&gt;

This command swaps the I and Q signal components if set to ON.

**Parameters:**

&lt;State&gt; 0 | 1 | OFF | ON

\*RST: 0

**Example:**

:IQ:OUTP:SWAP ON

swaps the I and Q channel of the I/Q output signal.

**Options:** R&S AMU-B13; SOURce2 only with a second option R&S AMU-B13 and second options R&S AMU-B16 and -B18.

**Manual operation:** See "[I/Q-Swap](#)" on page 210

### 7.15.5.2 Analog I/Q Outputs

This subsystem contains the commands for configuring the differential output.

For information about the required options, see [Chapter 5.5.3, "Analog I/Q Output Settings"](#), on page 212.

<code>[ :SOURce&lt;hw&gt;]:IQ:OUTPut[:ANALog]:BIAS:COUPling[:STATe]</code> .....	642
<code>[ :SOURce&lt;hw&gt;]:IQ:OUTPut[:ANALog]:BIAS:I</code> .....	642
<code>[ :SOURce&lt;hw&gt;]:IQ:OUTPut[:ANALog]:BIAS:Q</code> .....	642
<code>[ :SOURce&lt;hw&gt;]:IQ:OUTPut[:ANALog]:OFFSet:I</code> .....	643
<code>[ :SOURce&lt;hw&gt;]:IQ:OUTPut[:ANALog]:OFFSet:Q</code> .....	643
<code>[ :SOURce&lt;hw&gt;]:IQ:OUTPut[:ANALog]:CFS?</code> .....	643
<code>[ :SOURce&lt;hw&gt;]:IQ:OUTPut[:ANALog]:CFSN?</code> .....	644
<code>[ :SOURce&lt;hw&gt;]:IQ:OUTPut[:ANALog]:ILOSs?</code> .....	644
<code>[ :SOURce&lt;hw&gt;]:IQ:OUTPut[:ANALog]:LOAD</code> .....	644
<code>[ :SOURce&lt;hw&gt;]:IQ:OUTPut[:ANALog]:PON</code> .....	645
<code>[ :SOURce&lt;hw&gt;]:IQ:OUTPut[:ANALog]:POWER:LEVel</code> .....	645
<code>[ :SOURce&lt;hw&gt;]:IQ:OUTPut[:ANALog]:POWER:PEP</code> .....	646
<code>[ :SOURce&lt;hw&gt;]:IQ:OUTPut[:ANALog]:POWER:PEP:RESult?</code> .....	646
<code>[ :SOURce&lt;hw&gt;]:IQ:OUTPut[:ANALog]:POWER:STEP:MODE</code> .....	647
<code>[ :SOURce&lt;hw&gt;]:IQ:OUTPut[:ANALog]:POWER:STEP[:INCRement]</code> .....	647
<code>[ :SOURce&lt;hw&gt;]:IQ:OUTPut:ANALog:STATe</code> .....	648
<code>[ :SOURce&lt;hw&gt;]:IQ:OUTPut[:ANALog]:TYPE</code> .....	648

---

**`[ :SOURce<hw>]:IQ:OUTPut[:ANALog]:BIAS:COUPling[:STATe] <State>`**

Couples the bias setting of the I and Q signal components.

If coupling is activated, settings made for the I-signal component (`[ :SOURce<hw>]:IQ:OUTPut[:ANALog]:BIAS:I`) automatically applies to the Q-signal (`[ :SOURce<hw>]:IQ:OUTPut[:ANALog]:BIAS:Q`)

**Parameters:**

`<State>` 0 | 1 | OFF | ON  
`*RST:` 0

**Example:** `IQ:OUTP:BIAS:ANAL:COUP ON`  
 activates I/Q bias coupling.

**Manual operation:** See "[Couple IQ Bias](#)" on page 215

---

**`[ :SOURce<hw>]:IQ:OUTPut[:ANALog]:BIAS:I <I>`**  
**`[ :SOURce<hw>]:IQ:OUTPut[:ANALog]:BIAS:Q <Q>`**

Specifies the amplifier bias of the respective I/Q- component.

**Parameters:**

<Q> float  
 Range: -3.6 to 3.6  
 Increment: 0.002  
 \*RST: 0

**Example:** IQ:OUTP:ANAL:BIAS:Q 0.1 V  
 sets a bias of 100 mV for the Q-signal.

**Manual operation:** See "[Bias \(EMF\)](#)" on page 215

**[ :SOURce<hw>]:IQ:OUTPut[:ANALog]:OFFSet:I <I>**  
**[ :SOURce<hw>]:IQ:OUTPut[:ANALog]:OFFSet:Q <Q>**

Valid only for output type Differential (IQ:OUTP:ANAL:TYPE DIFF).

Sets an offset between the inverting and non-inverting output.

The offset refers to the load resistance. Changing the load type, the offset setting must be adjusted.

**Parameters:**

<Q> float  
 Range: -0.3 to 0.3  
 Increment: 1E-4  
 \*RST: 0

**Example:** IQ:OUTP:ANAL:TYPE DIFF  
 the I/Q-signal components are output differential  
 :IQ:OUTP:ANAL:OFFS:Q 0.05 V  
 sets an offset of 50 mV for the I-signal.

**Manual operation:** See "[Offset \(EMF\)](#)" on page 216

**[ :SOURce<hw>]:IQ:OUTPut[:ANALog]:CFS?**

This command queries crest factor of the analog output signal without noise. If auxiliary information on this level settings is activated, the crest factor is displayed in the status bar of the display (see [[:SOURce<hw>\]:IQ:OUTPut:DISPlay:AINformation](#) on page 640).

**Return values:**

<Cfs> float  
 Range: -100 to 100  
 Increment: 0.01  
 \*RST: 0

**Example:** :IQ:OUTP:CFS?  
 queries the crest factor of the analog output signal of path A.

**Usage:** Query only

**[ :SOURce<hw>]:IQ:OUTPut[:ANALog]:CFSN?**

This command queries ratio of the peak value of the analog output signal plus noise, to the rms level of the signal without noise. If auxiliary information on this level settings is activated, the parameter is displayed in the status bar of the display (see [ :SOURce<hw>]:IQ:OUTPut:DISPlay:AINformation on page 640).

**Return values:**

<Cfsn> float  
 Range: -100 to 100  
 Increment: 0.01  
 \*RST: 0

**Example:** :IQ:OUTP:CFSN?  
 queries the ratio of the peak value of the output signal.

**Usage:** Query only

**[ :SOURce<hw>]:IQ:OUTPut[:ANALog]:ILOSSs?**

This command queries the decrease in signal power of the analog baseband input signal resulting from insertion loss. Insertion loss is defined as the ratio of the input signal level to the output signal level. It is expressed in dB. If auxiliary information on the insertion loss is activated, the parameter is displayed in the status bar of the display (see [ :SOURce<hw>]:IQ:OUTPut:DISPlay:AINformation on page 640).

**Tip:** To enable the display settings both, baseband input and I/Q output display must be operated in the same mode, either in digital mode or analog mode.

**Return values:**

<ILoss> float  
 Range: -100 to 100  
 Increment: 0.01  
 \*RST: 0

**Example:** :IQ:OUTP:CFSN?  
 queries the ratio of the peak value of the output signal.

**Usage:** Query only

**[ :SOURce<hw>]:IQ:OUTPut[:ANALog]:LOAD <Load>**

This command selects the load type of the analog output signal. The analog outputs can be operated in single ended mode or differential (non-inverted) mode.

Depending on the output mode the load type varies:

- Single ended Output  
 The load type can be EMF (high-Z load) or 50 Ω.
- Differential Output  
 The load type can be EMF (high-Z load) or 100 Ω.

The selected load type is displayed in the status bar of the corresponding path.

**Parameters:**

<Load> EMF | L50Ohm | L100Ohm

**EMF**  
Load Type EMF ( $R_{LOAD} = \text{infinitely}$ ).

**L50Ohm**  
Load Type 50 Ohm ( $R_{LOAD} = 50 \text{ Ohm}$ ).

**L100Ohm**  
Load Type 100 Ohm ( $R_{LOAD} = 100 \text{ Ohm}$ ).

\*RST: EMF

**Example:**

```
:IQ:OUTP:TYP SING
selects the analog output signal type Single Ended.
:IQ:OUTP:LOAD EMF
the load type to EMF is set to the output signal.
```

**Options:**

B13 and B16 for differential output

**Manual operation:** See "[Load Type](#)" on page 214

**[:SOURce<hw>]:IQ:OUTPut[:ANALog]:PON <Pon>**

This command selects the state which the analog I/Q Output is to assume after the instrument is switched on.

For two-path instruments the power-on state can be set separately for each path.

**Parameters:**

<Pon> OFF | UNCHanged

\*RST: OFF

**Example:**

```
:IQ:OUTP:PON OFF
deactivates the output when the instrument is switched on
:IQ:OUTP:PON UNCH
sets the output to the status that was active before the last
switch off.
```

**Options:**

B13 and B16

**Manual operation:** See "[Power-On State](#)" on page 217

**[:SOURce<hw>]:IQ:OUTPut[:ANALog]:POWER:LEVEL <Level>**

Sets the output rms voltage for both signal components (I and Q). Level Vrms refers to the load resistance. When changing the load type, the level setting must be adjusted.

- Single ended Output:  
Value range: 20 mV ... 2 V EMF  
The maximum overall output voltage (Level EMF + |Bias|) is 3.7 V  
(for the load type 50 Ohm the limit is 1.85 V)
- Differential Output:  
Value range: 40 mV ... 4 V EMF.

The maximum overall output voltage is  $(0.5 * \text{PEP}_{\text{EMF}} + |\text{Bias}_{\text{EMF}}| + 0.5 * \text{Offset}_{\text{EMF}})$  is 3.7 V

For the load type 100 Ohm the limit is 1.85 V.

**Parameters:**

<Level> float  
 Range: 0.2 to 4  
 Increment: 0.001  
 \*RST: 1

**Example:**

:IQ:OUTP:POW:LEV 0.25 V  
 sets the output rms voltage  $V_{\text{rms}}$  to 0.25 V.

**Options:**

B13 and B16

**Manual operation:** See "[Level  \$V\_{\text{rms}}\$](#) " on page 214

**[:SOURce<hw>]:IQ:OUTPut[:ANALog]:POWer:PEP <Pep>**

Sets the output peak envelope voltage for both signal components (I and Q). PEP  $V_p$  refers to the load resistance. Setting EMF the entire value range is available. Using 50 Ohm or 100 Ohm, the value range decreases and the PEP setting must be adjusted to the load type. The range of values changes proportional to the load type.

Single ended Output:

- Value range: 20 mV ... 2 V EMF.
- The maximum overall output voltage ( $\text{SOUR:IQ:OUTP:POW:PEP} + \text{SOUR:IQ:OUTP:BIAS:I|Q}$ ) is 3.7 V

Differential Output:

- Value range: 40 mV ... 4 V EMF.
- The maximum overall output voltage ( $0.5 * \text{SOUR:IQ:OUTP:POW:PEP} + \text{SOUR:IQ:OUTP:BIAS:I|Q} + 0.5 * \text{SOUR:IQ:OUTP:OFFS:I|Q}$ ) is 3.7 V

**Parameters:**

<Pep> float  
 Range: 0.02 to 2  
 Increment: 0.001  
 \*RST: 1  
 Default unit: V

**Example:**

IQ:OUTP:POW:PEP 2 V  
 sets a off-load level of 2 V

**Manual operation:** See "[Pep  \$V\_p\$](#) " on page 214

**[:SOURce<hw>]:IQ:OUTPut[:ANALog]:POWer:PEP:RESult?**

This command queries the resulting I/Q Level value.

**Return values:**

<Result> float  
 Range: 0.02 to 4  
 Increment: 0.001  
 \*RST: 1

**Usage:** Query only

**[[:SOURce<hw>]:IQ:OUTPut[:ANALog]:POWer:STEP:MODE <Mode>**

This command activates (USER) or deactivates (DECimal) the user-defined step width used when varying the level value with the level values UP/DOWN. The command is linked to setting "Variation Active" for manual operation, i.e. the command also activates/deactivates the user-defined step width used when varying the level value with the rotary knob.

For two-path instruments the step width can be set separately for each path.

**Parameters:**

<Mode> DECimal | USER  
 \*RST: DECimal

**Example:**

:IQ:OUTP:POW:STEP:MODE USER  
 activates the step width for level variation with the rotary knob (manual operation) and with level values UP/DOWN (remote control).

**Options:** B13 and B16

**Manual operation:** See "[Variation Active](#)" on page 215

**[[:SOURce<hw>]:IQ:OUTPut[:ANALog]:POWer:STEP[:INCRement] <Increment>**

The command sets the step width for the frequency setting if the frequency values UP/DOWN are used and variation mode SOUR:IQ:OUTP:POW:STEP:MODE USER is selected. The command is linked to "Variation Step" for manual operation, i.e. the command also sets the step width of the rotary knob for "Variation Active ON".

For two-path instruments the step width can be set separately for each path.

**Parameters:**

<Increment> float  
 Range: 0.02 to 4  
 Increment: 1E-3  
 \*RST: 1

**Example:**

SOUR:IQ:OUTP:ANAL:POW:STEP:INCR 50 mV  
 sets the step width for the level setting to 50 mV.

**Options:** B13 and B16

**Manual operation:** See "[Variation Step](#)" on page 215

**[[:SOURce<hw>]:IQ:OUTPut:ANALog:STATe <State>**

Switches the analog I/Q output signals on and off.

**Parameters:**

<State> 0 | 1 | OFF | ON  
\*RST: 0

**Example:**

:IQ:OUTP:ANAL:STAT ON  
'the analog I/Q output signals of path A are activated.

**Options:**

B13; SOURce2 only with a second option B13 and second options B16 and B18.

**Manual operation:** See "State" on page 212

**[[:SOURce<hw>]:IQ:OUTPut[:ANALog]:TYPE <Type>**

Selects an input type.

**Parameters:**

<Type> SINGle | DIFFerential

**SINGle**

The I/Q-signal components are output single-ended.

**DIFFerential**

The I/Q-signal components are output differential.

\*RST: SINGle

**Example:**

IQ:OUTP:ANAL:TYPE DIFF  
the I/Q-signal components are output differential.

**Options:**

B13 and B16

**Manual operation:** See "I/Q Output Type" on page 213

### 7.15.5.3 Digital I/Q Outputs

This subsystem contains the commands for configuring the digital I/Q output. The digital signal can be output with the aid of a standardized (LVDS) digital user interface.

For information about the required options, see [Chapter 5.5.4, "Digital I/Q Output Settings"](#), on page 217.

<a href="#">[:SOURce&lt;hw&gt;]:IQ:OUTPut:DIGital:CDEvice?</a> .....	649
<a href="#">[:SOURce&lt;hw&gt;]:IQ:OUTPut:DIGital:CFS?</a> .....	649
<a href="#">[:SOURce&lt;hw&gt;]:IQ:OUTPut:DIGital:CFSN?</a> .....	649
<a href="#">[:SOURce&lt;hw&gt;]:IQ:OUTPut:DIGital:ILOSs?</a> .....	650
<a href="#">[:SOURce]:IQ:OUTPut:DIGital:OFLow:HOLD:RESet</a> .....	650
<a href="#">[:SOURce]:IQ:OUTPut:DIGital:OFLow:HOLD:STATe?</a> .....	650
<a href="#">[:SOURce]:IQ:OUTPut:DIGital:OFLow:STATe?</a> .....	651
<a href="#">[:SOURce&lt;hw&gt;]:IQ:OUTPut:DIGital:PON</a> .....	651
<a href="#">[:SOURce&lt;hw&gt;]:IQ:OUTPut:DIGital:POWER:LEVel</a> .....	651
<a href="#">[:SOURce&lt;hw&gt;]:IQ:OUTPut:DIGital:POWER:PEP</a> .....	651



<a href="#">[:SOURce&lt;hw&gt;]:IQ:OUTPut:DIGital:POWer:STEP[:INCRement]</a> .....	652
<a href="#">[:SOURce&lt;hw&gt;]:IQ:OUTPut:DIGital:POWer:STEP:MODE</a> .....	652
<a href="#">[:SOURce&lt;hw&gt;]:IQ:OUTPut:DIGital:SRATe</a> .....	653
<a href="#">[:SOURce&lt;hw&gt;]:IQ:OUTPut:DIGital:SRATe:FIFO[:STATus]?</a> .....	653
<a href="#">[:SOURce&lt;hw&gt;]:IQ:OUTPut:DIGital:SRATe:SOURce</a> .....	653
<a href="#">[:SOURce&lt;hw&gt;]:IQ:OUTPut:DIGital:STATe</a> .....	654

---

### **[\[:SOURce<hw>\]:IQ:OUTPut:DIGital:CDEVICE?](#)**

Queries the ID of a connected Rohde&Schwarz instrument.

**Return values:**

<CDevice>                      string

**Example:**                      `IQ:OUTP:DIG:CDEV?`  
queries the connected device ID.

**Usage:**                         Query only

**Manual operation:**    See "[Connected Device - Digital I/Q Out](#)" on page 222

---

### **[\[:SOURce<hw>\]:IQ:OUTPut:DIGital:CFS?](#)**

Queries the crest factor of the digital output signal without noise. If auxiliary information on this level settings is activated, the crest factor is displayed in the status bar of the display (see [\[:SOURce<hw>\]:IQ:OUTPut:DISPlay:AINFormation](#) on page 640).

**Return values:**

<Cfs>                              float  
Range:                      -100 to 100  
Increment:                  0.01  
\*RST:                         0

**Example:**                      `SOURce:IQ:OUTPut:DIGital:CFS?`  
queries the crest factor of the digital output signal of path A.

**Usage:**                         Query only

---

### **[\[:SOURce<hw>\]:IQ:OUTPut:DIGital:CFSN?](#)**

Queries ratio of the peak value of the digital output signal plus noise, to the rms level of the signal without noise. If auxiliary information on this level settings is activated, the parameter is displayed in the status bar of the display (see [\[:SOURce<hw>\]:IQ:OUTPut:DISPlay:AINFormation](#) on page 640).

**Return values:**

<Cfsn>                              float  
Range:                      -100 to 100  
Increment:                  0.01  
\*RST:                         0

**Example:**                      `SOURce:IQ:OUTPut:DIGital:CFSN?`  
queries the ratio of the peak value of the output signal.

**Usage:** Query only

---

#### **[ :SOURce<hw>]:IQ:OUTPut:DIGital:ILOSs?**

Queries the decrease in signal power of the digital baseband input signal resulting from insertion loss. Insertion loss is defined as the ratio of the input signal level to the output signal level. It is expressed in dB. If auxiliary information on the insertion loss is activated, the parameter is displayed in the status bar of the display (see [ :SOURce<hw>]:IQ:OUTPut:DISPlay:AINformation on page 640).

**Tip:** To enable the display settings both, baseband input and I/Q output display must be operated in the same mode, either in digital mode or analog mode.

#### **Return values:**

<lloss> float  
 Range: -100 to 100  
 Increment: 0.01  
 \*RST: 0

**Example:** :IQ:OUTP:DIG:CFSN?  
 queries the ratio of the peak value of the output signal.

**Usage:** Query only

---

#### **[ :SOURce]:IQ:OUTPut:DIGital:OFLow:HOLD:RESet**

Resets the overflow hold state and LED.

**Example:** SOUR:IQ:OUTP:DIG:OFL:HOLD:RESet  
 resets the overflow hold state.

**Usage:** Event

**Manual operation:** See "Reset - Digital I/Q Out" on page 221

---

#### **[ :SOURce]:IQ:OUTPut:DIGital:OFLow:HOLD:STATe?**

Queries an overflow since the last reset.

To reset the overflow hold state, use one of the following:

- send the command [ :SOURce]:IQ:OUTPut:DIGital:OFLow:HOLD:RESet
- start a new signal generation
- set a new output level

#### **Return values:**

<State> 0 | 1 | OFF | ON  
 \*RST: 0

**Example:** SOUR:IQ:OUTP:DIG:OFL:HOLD:STAT?  
 Response: "0" (no overflow)

**Usage:** Query only

**Manual operation:** See ["Overflow Hold - Digital I/Q Out"](#) on page 221

#### **[:SOURce]:IQ:OUTPut:DIGital:OFLow:STATe?**

Queries the current overflow state of the output signal and indicates that the I/Q output signal is currently clipped.

**Return values:**

<State>            0 | 1 | OFF | ON  
 \*RST:            0

**Example:**

`IQ:OUTP:DIG:OFL:STAT?`  
 queries the overflow state.  
 Response: "0" (no overflow).

**Usage:**            Query only

**Manual operation:** See ["Overflow - Digital I/Q Out "](#) on page 221

#### **[:SOURce<hw>]:IQ:OUTPut:DIGital:PON <Pon>**

Selects the state which the digital I/Q Output is to assume after the instrument is switched on.

**Parameters:**

<Pon>            OFF | UNCHanged  
 \*RST:            OFF

**Example:**

`SOURce:IQ:OUTPut:DIGital:PON OFF`  
 deactivates the output when the instrument is switched on.

**Manual operation:** See ["Power-On State - Digital I/Q Out"](#) on page 222

#### **[:SOURce<hw>]:IQ:OUTPut:DIGital:POWER:LEVel <Level>**

Sets the rms level of the digital output signal.

**Parameters:**

<Level>            float  
 Range:            -90 to 0  
 Increment:        0.01  
 \*RST:            0  
 Default unit:      dBFS

**Example:**

`IQ:OUTP:DIG:POW:LEV -10`  
 sets the output signal level to -10 dBFS.

**Manual operation:** See ["Level - Digital I/Q Out"](#) on page 220

#### **[:SOURce<hw>]:IQ:OUTPut:DIGital:POWER:PEP <Pep>**

Sets the peak envelope power of the digital output signal (PEP).

**Parameters:**

<Pep> float  
 Range: -90 to 0  
 Increment: 0.01  
 \*RST: 0  
 Default unit: dBFS

**Example:**

`IQ:OUTP:DIG:POW:PEP -10`  
 sets the signal output level to -10 dBFS.

**Manual operation:** See ["Peak Level - Digital I/Q Out"](#) on page 220

**[:SOURce<hw>]:IQ:OUTPut:DIGital:POWER:STEP[:INCRement] <Increment>**

Sets the step width for the frequency setting if the frequency values UP/DOWN are used and variation mode `SOUR:IQ:OUTP:DIG:POW:STEP:MODE USER` is selected. The command is linked to "Variation Step" for manual operation, i.e. the command also sets the step width of the rotary knob for "Variation Active ON".

**Parameters:**

<Increment> float  
 Range: 0 to 100  
 Increment: 0.01  
 \*RST: 1  
 Default unit: dB

**Example:**

`SOUR:IQ:OUTP:ANAL:POW:STEP:INCR 50 mV`  
 sets the step width for the level setting to 50 mV.

**Manual operation:** See ["Variation Step - Digital I/Q Out"](#) on page 221

**[:SOURce<hw>]:IQ:OUTPut:DIGital:POWER:STEP:MODE <Mode>**

Activates (USER) or deactivates (DECimal) the user-defined step width used when varying the level value with the level values UP/DOWN. The command is linked to setting "Variation Active" for manual operation, i.e. the command also activates/deactivates the user-defined step width used when varying the level value with the rotary knob.

**Parameters:**

<Mode> DECimal | USER  
 \*RST: DECimal

**Example:**

`IQ:OUTP:DIG:POW:STEP:MODE USER`  
 activates the step width for level variation with the rotary knob (manual operation) and with level values UP/DOWN (remote control).

**Manual operation:** See ["Variation Active - Digital I/Q Out"](#) on page 221

**[ :SOURce<hw> ]:IQ:OUTPut:DIGital:SRATe <SRate>**

Using the sample rate source User, the command sets the sample rate value of the output signal. This command is not active for external clock sources

**Parameters:**

<SRate> float  
 Range: 400 to max  
 Increment: 0.001  
 \*RST: 1E8

**Example:**

IQ:OUTP:DIG:SRAT:MODE USER  
 with sample rate source User the internally generated clock reference signal is selected.  
 IQ:OUTP:DIG:SRAT 100 MHz  
 the sample rate for the output signal is set to 100 MHz.

**Manual operation:** See ["Sample Rate Value - Digital I/Q Output"](#) on page 219

**[ :SOURce<hw> ]:IQ:OUTPut:DIGital:SRATe:FIFO[:STATus]?**

Queries the state of the signal transmission.

**Return values:**

<Status> OK | OFLow | URUN  
**OK**  
 Resampling is working properly.  
**OFLow (Overflow)**  
 The external sample rate frequency is too high which causes an overflow in signal transmission.  
**URUN (Underrun)**  
 The external sample rate is too low which causes an underrun in signal transmission.  
 \*RST: OK

**Example:**

SOUR:BBIN:SRAT:FIFO:STATus?  
 queries the FIFO Status of the sample rate.

**Usage:** Query only

**Manual operation:** See ["FIFO Status - Digital I/Q Output"](#) on page 219

**[ :SOURce<hw> ]:IQ:OUTPut:DIGital:SRATe:SOURce <Source>**

Selects the source for setting the sample rate of the digital I/Q output signal.

**Note:** With a connected R&S EX-IQ-Box either the internal clock source (User defined) or an external clock (Digital I/Q In) can be selected in the settings dialog of the R&S EX-IQ-Box. Therefore, the sample rate source is only indicated in this field.

**Parameters:**

&lt;Source&gt;

USER | DIN | DOUT | USER | DOUT | DIN

**USER**

The internally generated clock reference signal is used. The sample rate is calculated and displayed in the field "Value".

**DIN**

An external clock reference signal is used. The clock signal is fed in via a "Baseband Input Module" (option R&S AMU-B17). The sample rate is estimated and displayed in the field "Value".

**DOUT**

An external clock reference signal is used. The clock signal is directly fed in via pin CLK2 of the digital output interface (option R&S AMU-B18, Digital I/Q Out). The sample rate is displayed in the field "Value".

\*RST: USER

**Example:**

IQ:OUTP:DIG:SRAT:SOUR USER

the internally generated clock reference signal is selected.

**Options:**

USER only with option R&S AMU-B13; DIN only with option R&S AMU-B17; DOUT only with option R&S AMU-B18; SOURce2 only with second options R&S AMU-B13, -B17 and -B18

**Manual operation:** See ["Sample Rate Source - Digital I/Q Output"](#) on page 218

[:SOURce&lt;hw&gt;]:IQ:OUTPut:DIGital:STATe &lt;State&gt;

Switches on and off the digital I/Q output signals.

**Parameters:**

&lt;State&gt;

0 | 1 | OFF | ON

\*RST: 0

**Example:**

IQ:OUTP:DIG:STAT ON

the digital I/Q output signals of path A are activated.

**Manual operation:** See ["State - Digital I/Q Output"](#) on page 218

## 7.15.6 SOURce:PATH Subsystem

This subsystem contains the command for retrieving the number of installed RF paths.

## 7.15.7 SOURce:ROSCillator Subsystem

This subsystem contains the commands for setting the external and internal reference frequency.



The settings of the reference oscillator are not affected by an instrument reset (**\*RST** on page 428). They are only reset to factory state by the factory-preset (**:SYSTEM:FPRReset** on page 431).

<b>[:SOURce]:ROSCillator:EXTernal:FREQuency</b> .....	655
<b>[:SOURce]:ROSCillator[:INTernal]:ADJust:VALue</b> .....	655
<b>[:SOURce]:ROSCillator[:INTernal]:ADJust[:STATe]</b> .....	655
<b>[:SOURce]:ROSCillator:SOURce</b> .....	656

### **[:SOURce]:ROSCillator:EXTernal:FREQuency** <Frequency>

Selects the external reference frequency.

#### **Parameters:**

<Frequency>            5MHZ | 10MHZ | 13MHZ  
**\*RST:**                10MHZ

#### **Example:**

ROSC:SOUR EXT  
 selects the external source. The reference must be input at the REF IN connector.  
 ROSC:EXT:FREQ 5MHz  
 selects 5 MHz external reference frequency.

**Manual operation:** See "[External Reference Frequency](#)" on page 140

### **[:SOURce]:ROSCillator[:INTernal]:ADJust:VALue** <Value>

Specifies the frequency correction value (adjustment value).

#### **Parameters:**

<Value>                integer  
 Range:                0 to maximum value (see data sheet)  
 Increment:           see data sheet  
**\*RST:**                ---

#### **Example:**

ROSC:ADJ:VAL 456  
 sets the adjustment value to 456.

**Manual operation:** See "[Adjustment DAC Value](#)" on page 140

### **[:SOURce]:ROSCillator[:INTernal]:ADJust[:STATe]** <State>

Determines whether the calibrated (OFF) or a user-defined (ON) adjustment value is used for fine adjustment of the frequency. With STATE ON, the instrument is no longer in the calibrated state. However, the calibration value is not changed and the instrument resumes the calibrated state after switching the Adjustment State to Off.

#### **Parameters:**

<State>                0 | 1 | OFF | ON  
**\*RST:**                --

**Example:**           ROSC:SOUR INT  
                          selects the internal source.  
                          ROSC:ADJ ON  
                          activates use of a user-defined adjustment value.  
                          ROSC:ADJ:VAL 1400  
                          sets the adjustment value to 1400.

**Manual operation:** See "[Adjustment Active](#)" on page 140

**[:SOURce]:ROSCillator:SOURce <Source>**

Selects the reference frequency source.

**Parameters:**

<Source>           INTernal | EXTernal | ELOop

**INTernal**

The internal reference oscillator is used.

**EXTernal**

An external reference signal is used. It must be input at the REF IN connector at the rear of the instrument.

\*RST:           ---

**Example:**           ROSC:SOUR EXT  
                          selects the external source.  
                          ROSC:EXT:FREQ 5 MHz  
                          informs the instrument that the external reference has a frequency of 5 MHz.

**Manual operation:** See "[Source](#)" on page 139

## 7.16 STATus Subsystem

This system contains the commands for the status reporting system. See also [Chapter 6.5, "Status Reporting System"](#), on page 415 for detailed information.

\*RST on page 428 has no effect on the status registers.

### Value ranges

- Queries return the current value of the respective register, which permits a check of the device status.  
Return values: A decimal value in the range 0 to 32767 ( $=2^{15}-1$ )
- The configuration commands set the respective register thus determining which status changes of the R&S AMU cause the status registers to be changed.  
Setting values: A decimal value in the range 0 to 32767 ( $=2^{15}-1$ )

<a href="#">:STATus:OPERation:CONDition</a> .....	657
<a href="#">:STATus:OPERation:ENABLE</a> .....	657
<a href="#">:STATus:OPERation[:EVENT]</a> .....	657
<a href="#">:STATus:OPERation:NTRansition</a> .....	657



:STATus:OPERation:PTRansition.....	658
:STATus:PRESet.....	658
:STATus:QUEStionable:CONDition.....	658
:STATus:QUEStionable:ENABle.....	659
:STATus:QUEStionable[:EVENT].....	659
:STATus:QUEStionable:NTRansition.....	659
:STATus:QUEStionable:PTRansition.....	659
:STATus:QUEue[:NEXT]?.....	660

---

#### :STATus:OPERation:CONDition <Condition>

Sets the content of the CONDition part of the STATus:OPERation register. This part contains information on the action currently being performed in the instrument. The content is not deleted after being read out because it indicates the current hardware status.

##### Parameters:

<Condition>                    string

##### Example:

```
:STATus:OPERation:CONDition?
queries the Status:Operation:Condition register.
```

---

#### :STATus:OPERation:ENABle <Enable>

Sets the bits of the ENABle part of the STATus:OPERation register. This setting determines which events of the Status-Event part are forwarded to the sum bit in the status byte. These events can be used for a service request.

##### Parameters:

<Enable>                        string

##### Example:

```
:STAT:OPER:ENAB 32767
all events are forwarded to the sum bit of the status byte.
```

---

#### :STATus:OPERation[:EVENT] <Event>

Queries the content of the EVENT part of the STATus:OPERation register. This part contains information on the actions performed in the instrument since the last readout. The content of the EVENT part is deleted after being read out.

##### Parameters:

<Event>                         string

##### Example:

```
:STAT:OPER:EVENT?
queries the STATus:OPERation:EVENT register.
```

---

#### :STATus:OPERation:NTRansition <Ntransition>

Sets the bits of the NTRansition part of the STATus:OPERation register. If a bit is set, a transition from 1 to 0 in the condition part causes an entry to be made in the EVENT part of the register. The disappearance of an event in the hardware is thus registered, for example the end of an adjustment.

**Parameters:**

<Ntransition> string

**Example:**

```
:STAT:OPER:NTR 0
```

a transition from 1 to 0 in the condition part of the Status:Operation register does not cause an entry to be made in the EVENT part.

**:STATus:OPERation:PTRansition <Ptransition>**

Sets the bits of the PTRansition part of the STATus:OPERation register. If a bit is set, a transition from 0 to 1 in the condition part causes an entry to be made in the EVENT part of the register. A new event in the hardware is thus registered, for example the start of an adjustment.

**Parameters:**

<Ptransition> string

**Example:**

```
:STAT:OPER:PTR 32767
```

all transitions from 0 to 1 in the condition part of the Status:Operation register cause an entry to be made in the EVENT part.

**:STATus:PRESet <Preset>**

Resets the status registers. All PTRansition parts are set to FFFFh (32767), i.e. all transitions from 0 to 1 are detected. All NTRansition parts are set to 0, i.e. a transition from 1 to 0 in a CONDition bit is not detected. The ENABLE parts of STATus:OPERation and STATus:QUEStionable are set to 0, i.e. all events in these registers are not passed on.

**Parameters:**

<Preset> string

**Example:**

```
STAT:PRES
```

resets the status registers.

**:STATus:QUEStionable:CONDition <Condition>**

Queries the content of the CONDition part of the STATus:QUEStionable register. This part contains information on the action currently being performed in the instrument. The content is not deleted after being read out since it indicates the current hardware status.

**Parameters:**

<Condition> string

**Example:**

```
:STATus:QUEStionable:CONDition?
```

queries the Status:Questionable:Condition register.

---

**:STATus:QUESTionable:ENABle** <Enable>

Sets the bits of the ENABle part of the STATus:QUESTionable register. This setting determines which events of the Status-Event part are enabled for the sum bit in the status byte. These events can be used for a service request.

**Parameters:**

<Enable> string

**Example:**

`STAT:OPER:ENAB 1`  
problems when performing an adjustment cause an entry to be made in the sum bit.

---

**:STATus:QUESTionable[:EVENT]** <Event>

Queries the content of the EVENT part of the STATus:QUESTionable register. This part contains information on the actions performed in the instrument since the last readout. The content of the EVENT part is deleted after being read out.

**Parameters:**

<Event> string

**Example:**

`STAT:QUES:EVEN?`  
queries the Status:Questionable:Event register.

---

**:STATus:QUESTionable:NTRansition** <Ntransition>

Sets the bits of the NTRansition part of the STATus:QUESTionable register. If a bit is set, a transition from 1 to 0 in the condition part causes an entry to be made in the EVENT part of the register.

**Parameters:**

<Ntransition> string

**Example:**

`STAT:OPER:NTR 0`  
a transition from 1 to 0 in the condition part of the Status:Questionable register does not cause an entry to be made in the EVENT part

---

**:STATus:QUESTionable:PTRansition** <PTransition>

Sets the bits of the PTRansition part of the STATus:QUESTionable register. If a bit is set, a transition from 1 to 0 in the condition part causes an entry to be made in the EVENT part of the register.

**Parameters:**

<PTransition> string

**Example:**

`:STAT:OPER:PTR 32767`  
all transitions from 0 to 1 in the condition part of the Status:Questionable register cause an entry to be made in the EVENT part

**:STATus:QUEue[:NEXT]?**

Queries the oldest entry in the error queue and then deletes it. Positive error numbers denote device-specific errors, and negative error numbers denote error messages defined by SCPI. If the error queue is empty, 0 ("No error") is returned.

The command is identical to `:SYSTem:ERRor[:NEXT]?` on page 662.

**Return values:**

<Next>                    string

**Example:**

`:STATus:QUEue?`

queries the oldest entry in the error queue.

Response: 0, 'no error'

no errors have occurred since the error queue was last read out

**Usage:**

Query only

**Manual operation:** See "History" on page 103

## 7.17 SYSTem Subsystem

The SYSTem subsystem contains a series of commands for general functions which do not directly affect signal generation.

<code>:SYSTem:ERRor:ALL?</code> .....	661
<code>:SYSTem:ERRor:CODE:ALL?</code> .....	661
<code>:SYSTem:ERRor:CODE[:NEXT]?</code> .....	662
<code>:SYSTem:ERRor:COUNT?</code> .....	662
<code>:SYSTem:ERRor[:NEXT]?</code> .....	662
<code>:SYSTem:SERRor?</code> .....	663
<code>:SYSTem:COMMunicate:GPIB:LTERminator</code> .....	663
<code>:SYSTem:COMMunicate:GPIB[:SELF]:ADDRess</code> .....	663
<code>:SYSTem:COMMunicate:NETWork[:COMMON]:WORKgroup</code> .....	664
<code>:SYSTem:COMMunicate:NETWork[:IPAddress]:DNS</code> .....	664
<code>:SYSTem:COMMunicate:NETWork:STATus?</code> .....	664
<code>:SYSTem:COMMunicate:NETWork:REStart</code> .....	664
<code>:SYSTem:COMMunicate:GPIB:RESource?</code> .....	664
<code>:SYSTem:COMMunicate:NETWork:RESource?</code> .....	665
<code>:SYSTem:COMMunicate:HISLip:RESource?</code> .....	665
<code>:SYSTem:COMMunicate:SOCKet:RESource?</code> .....	665
<code>:SYSTem:PROTect&lt;ch&gt;[:STATe]</code> .....	666
<code>:SYSTem:STARtup:COMPLet?</code> .....	666
<code>:SYSTem:DISPlay:UPDate</code> .....	666
<code>:SYSTem:DATE</code> .....	667
<code>:SYSTem:HCLear</code> .....	667
<code>:SYSTem:TIME</code> .....	667
<code>:SYSTem:TIME:ZONE</code> .....	668
<code>:SYSTem:TIME:ZONE:CATalog?</code> .....	668
<code>:SYSTem:VERSIon?</code> .....	668

:SYSTem:BIOS:VERsion?.....	668
:SYSTem:OSYStem?.....	668
:SYSTem:MMEMory:PATH:USER?.....	669

---

### :SYSTem:ERRor:ALL?

Queries the error/event queue for all unread items and removes them from the queue. The response is a comma separated list of error number and a short description of the error in FIFO order.

Positive error numbers are instrument-dependent. Negative error numbers are reserved by the SCPI standard.

#### Return values:

<All> string  
 List of: Error/event\_number,"Error/event\_description">[:Device-dependent info]"  
 If the queue is empty, the response is 0, "No error"

**Example:** SYST:ERR:ALL?  
 queries all entries in the error queue.  
 Response: 0, 'no error'  
 No errors have occurred since the error queue was last read out.

**Usage:** Query only

**Manual operation:** See "[Del. volatile](#)" on page 103

---

### :SYSTem:ERRor:CODE:ALL?

Queries all entries in the error queue and then deletes them. Only the error numbers are returned and not the entire error text.

#### Return values:

<All> string  
**0**  
 "No error", i.e. the error queue is empty  
**positive value**  
 Positive error numbers denote device-specific errors  
**negative value**  
 Negative error numbers denote error messages defined by SCPI.

**Example:** SYST:ERR:CODE:ALL  
 queries all entries in the error queue.  
 Response: 0  
 no errors have occurred since the error queue was last read out.

**Usage:** Query only

---

**:SYSTem:ERRor:CODE[:NEXT]?**

Queries the oldest entry in the error queue and then deletes it. Only the error number is returned and not the entire error text.

**Return values:**

<Next> string  
**0**  
 "No error", i.e. the error queue is empty  
**positive value**  
 Positive error numbers denote device-specific errors  
**negative value**  
 Negative error numbers denote error messages defined by SCPI.

**Example:**

SYST:ERR:CODE  
 queries the oldest entry in the error queue.  
 Response: 0  
 No errors have occurred since the error queue was last read out.

**Usage:** Query only

---

**:SYSTem:ERRor:COUNT?**

Queries the number of entries in the error queue. If the error queue is empty, '0' is returned.

**Return values:**

<Count> string

**Example:**

SYST:ERR:COUN  
 queries the number of entries in the error queue.  
 Response: 1  
 One error has occurred since the error queue was last read out.

**Usage:** Query only

---

**:SYSTem:ERRor[:NEXT]?**

Queries the error/event queue for the oldest item and removes it from the queue. The response consists of an error number and a short description of the error.

Positive error numbers are instrument-dependent. Negative error numbers are reserved by the SCPI standard.

**Return values:**

<Next> string  
 Error/event\_number,"Error/event\_description>[:Device-dependent info]"  
 If the queue is empty, the response is 0, "No error"

**Example:**           SYST:ERR?  
 queries the oldest entry in the error queue.  
 Response: 0, 'no error'  
 No errors have occurred since the error queue was last read out.

**Usage:**            Query only

**Manual operation:** See "History" on page 103

**:SYSTem:SERRor?**

This command returns a list of all errors existing at the time when the query is started. This list corresponds to the display on the info page under manual control.

**Return values:**

<StaticErrors>       string

**Example:**           SYSTem:SERRor?  
 queries all errors existing in the error queue.  
 Response: -221, 'Settings conflict', 153,  
 'Input voltage out of range'  
 the two returned errors have occurred since the error queue was last queried.

**Usage:**            Query only

**:SYSTem:COMMunicate:GPIB:LTERminator <LTerminator>**

Sets the terminator recognition for remote control via GPIB bus.

**Parameters:**

<LTerminator>       STANdard | EOI

**EOI**

The terminator must be sent together with the line message EOI (End of Line). This setting is recommended for binary block transmissions where a character could coincidentally have the value LF (Line Feed) but is not intended as the terminator. This setting must be selected for block data with undefined length.

**STANdard**

An LF (Line Feed) is recognized as the terminator regardless of whether it is sent with or without EOI.

\*RST:            STANdard

**Example:**           SYSTem:COMMunicate:GPIB:LTERminator EOI  
 only a character which is sent simultaneously with the line message EOI is accepted as the terminator.

**:SYSTem:COMMunicate:GPIB[:SELF]:ADDRess <Address>**

Sets the GPIB address.

**Parameters:**

<Address> integer  
 Range: 1 to 30  
 \*RST: 28

**Example:** SYSTEM:COMMunicate:GPIB:SELF:ADDRESS 28  
 sets GPIB address.

**Manual operation:** See "[GPIB channel address](#)" on page 155

**:SYSTEM:COMMunicate:NETWork[:COMMON]:WORKgroup <Workgroup>**

Sets the individual workgroup name of the instrument.

**Parameters:**

<Workgroup> string

**Example:** SYSTEM:COMMunicate:NETWork:COMMON:WORKgroup  
 'TEST\_09'  
 sets the workgroup name

**:SYSTEM:COMMunicate:NETWork[:IPAddress]:DNS <DNS>**

Determines the net DNS server to resolve the name.

**Parameters:**

<DNS> string

**Example:** SYST:COMM:NETW:IPAD:DNS 123.456.0.1

**:SYSTEM:COMMunicate:NETWork:STATus?**

Queries the network configuration state.

**Return values:**

<State> 0 | 1 | OFF | ON

**Usage:** Query only

**:SYSTEM:COMMunicate:NETWork:REStart**

Restarts the network connection to the instrument, terminates the connection and sets it up again.

**Example:** SYSTEM:COMMunicate:NETWork:REStart

**Usage:** Event

**:SYSTEM:COMMunicate:GPIB:RESource?**

Queries the visa resource string for remote control via the GPIB interface.



To change the GPIB address, use the command `:SYSTem:COMMunicate:GPIB[ :SELF] :ADDRess`.

**Return values:**

<Resource>            string

**Example:**

`SYSTem:COMMunicate:GPIB:RESource?`

queries the VISA resource string.

Response: "GPIB::28::INSTR"

**Usage:**

Query only

**Manual operation:** See "[Visa Resource Strings](#)" on page 155

---

**:SYSTem:COMMunicate:NETWork:RESource?**

Queries the VISA resource string, used for remote control of the instrument with VXI-11 protocol.

**Return values:**

<Resource>            string

**Example:**

`SYSTem:COMMunicate:NETWork:RESource?`

Response: "TCPIP::192.1.2.3::INSTR"

**Usage:**

Query only

**Manual operation:** See "[Visa Resource Strings](#)" on page 155

---

**:SYSTem:COMMunicate:HISLip:RESource?**

Queries the VISA resource string, used for remote control of the instrument with HiSLIP protocol.

**Return values:**

<Resource>            string

**Example:**

`SYSTem:COMMunicate:HISLip:RESource?`

Response: "TCPIP::192.1.2.3::hislip0::INSTR"

**Usage:**

Query only

**Manual operation:** See "[Visa Resource Strings](#)" on page 155

---

**:SYSTem:COMMunicate:SOCKet:RESource?**

Queries the visa resource string for remote control via LAN interface, using TCP/IP socket protocol.

**Return values:**

<Resource>            string

**Example:**

`SYSTem:COMMunicate:SOCKet:RESource?`

Response: "TCPIP::10.113.1.150::5025::SOCKET"

**Usage:**

Query only

**Manual operation:** See "[Visa Resource Strings](#)" on page 155

---

**:SYSTem:PROTect<ch>[:STATe] <State>[, <Key>]**

Activates/deactivates the specified protection level.

**Parameters:**

<State>                   select  
                              \*RST:        1

**Setting parameters:**

<Key>                   integer  
The respective functions are disabled when the protection level is activated. No password is required for activation. A password must be entered to deactivate the protection level. The password for the first level is 123456.  
This protection level can be used to lock-out internal adjustments.

**Example:**               SYSTem:PROTect1:STATe ON  
                              activates protection level 1. Internal adjustments are only possible after deactivating the lock-out.  
                              SYSTem:PROTect1:STATe OFF,123456  
                              deactivates protection level 1. Internal adjustments are enabled again.

**Manual operation:** See "[Protection Level/Password](#)" on page 158

---

**:SYSTem:STARtup:COMPLete?**

Queries if the startup of the instrument is completed.

**Return values:**

<Complete>               0 | 1 | OFF | ON  
                              \*RST:        0

**Example:**               SYST:STAR:COMP  
                              Response: 1  
                              The startup of the instrument is completed.

**Usage:**                   Query only

---

**:SYSTem:DISPlay:UPDate <Update>**

Switches the update of the display on/off. A switchover from remote control to manual control always sets the status of the update of the display to ON.

**Parameters:**

<Update>                   0 | 1 | OFF | ON  
                              \*RST:        ON

**Example:**               SYST:DISP:UPD OFF  
switches update of displayed parameter values off.

**Manual operation:** See "Display Update is On/Off" on page 146

**:SYSTEM:DATE** <Year>, <Month>, <Day>

Queries or sets the date for the instrument-internal calendar.

This parameter is protected, in order to prevent accidental changes.

It can be accessed with protection level 1, see :SYSTEM:PROTECT<ch>[:STATE] on page 666.

**Parameters:**

<Year>	<year>,<month>,<day>
<Month>	integer Range: 1 to 12
<Day>	integer Range: 1 to 31

**Example:**               SYST:DATE?  
Response: "2011,05,01"  
it is the 1st of May, 2011.

**:SYSTEM:HCLear**

Clears the history.

**Example:**               SYST:HCL  
Deletes the history entries.

**Usage:**                Event

**:SYSTEM:TIME** <Hour>, <Minute>, <Second>

Queries or sets the time for the instrument-internal clock.

The parameter is protected, in order to prevent accidental changes.

It can be accessed with protection level 1, see :SYSTEM:PROTECT<ch>[:STATE] on page 666.

**Parameters:**

<Hour>	0...23,0...59,0...59 Range: 0 to 23
<Minute>	integer Range: 0 to 59
<Second>	integer Range: 0 to 59

**Example:**               SYSTem:TIME?  
                          Response: "12, 0, 0" it is precisely 12 pm.

---

**:SYSTem:TIME:ZONE** <TimeZone>

Sets the time zone. You can query the list of the available time zones with `:SYSTem:TIME:ZONE:CATalog?`.

**Parameters:**

<TimeZone>               string

---

**:SYSTem:TIME:ZONE:CATalog?**

Queries the list of available time zones.

**Return values:**

<Catalog>

**Usage:**                 Query only

---

**:SYSTem:VERSion?**

Queries the SCPI version the instrument's command set complies with.

**Return values:**

<Version>               string

**Example:**

SYST:VERS

queries the SCPI version.

Response: "1996"

The instrument complies with the SCPI version from 1996.

**Usage:**                 Query only

---

**:SYSTem:BIOS:VERSion?**

Queries the BIOS version of the instrument.

**Return values:**

<Version>               string

**Example:**

SYSTem:BIOS:VERSion?

queries the BIOS version.

Response: '123456'

the instrument operates with BIOS version 123456.

**Usage:**                 Query only

---

**:SYSTem:OSYStem?**

Queries the operating system of the instrument.

**Return values:**`<OperSystem>` string**Example:**`SYSTem:OSYStem?`

Response: "Windows"

**Usage:**

Query only

**:SYSTem:MMEMory:PATH:USER?**

Queries the user directory, that means the directory the instrument stores user files on.

**Return values:**`<PathUser>` string**Example:**`SYSTem:MMEMory:PATH:USER?`

Response: "D:\user\"

**Usage:**

Query only

## 7.18 TEST Subsystem

The TEST system contains the commands for performing the routines as well as for direct manipulation of the hardware assemblies (`:TEST:DIRect`).

The self tests return a "0" if the test is performed successfully, otherwise a value other than "0" is returned. None of the commands of this system have an \*RST value.

**NOTICE****Improper use may destroy the assembly!**

The respective hardware assembly responds directly to the `:TEST:DIRect` command; any safety mechanisms are bypassed. The command is used for servicing purposes and should not be applied by the user.

<code>:TEST:BB:CONNectio?</code> .....	669
<code>:TEST:BBIN?</code> .....	670
<code>:TEST&lt;hw&gt;:BBIN:RBERror?</code> .....	670
<code>:TEST&lt;hw&gt;:BBOut:LRATe</code> .....	670
<code>:TEST&lt;hw&gt;:BBOut:TTEST[:STATe]</code> .....	671
<code>:TEST:CONNector:AUXio?</code> .....	671
<code>:TEST&lt;hw&gt;:DIRect</code> .....	671
<code>:TEST:FADer?</code> .....	671

**:TEST:BB:CONNectio?**

Queries the state of the connection between connectors USER1 and USER2.

A 0=PASS response indicates that the connection is established, whereas a response 1=FAIL stands for a faulty connection.

**Return values:**

<Connection> 0 | 1 | PASS | FAIL

**Usage:** Query only

**:TEST:BBIN?**

This command performs a selftest on the baseband input hardware options. Several analog diagnostics points are checked to verify the correct function of the module.

**Return values:**

<Bbin> 0 | 1 | OFF | ON

**Example:**

TEST:BBIN?

Response: "0" on success, "1" on fail

**Usage:** Query only

**:TEST<hw>:BBIN:RBError?**

This command performs a bit error rate test of the received test signal.

**Return values:**

<RbError> 0 | 1 | OFF | ON

**Example:**

TEST:BBIN:RBError?

Response: "0" on success, "1" on fail

**Usage:** Query only

**:TEST<hw>:BBOut:LRATe <LRate>**

The command sets the interface speed.

The "External LVDS Test" is used to check the correct data transmission of the digital baseband outputs (BBOU).

This test is also used to the correct data reception of the digital baseband inputs (BBIN).

An external cable connection is needed to perform this test successfully. An output must be connected to an input with the digital I/Q cable. Always an input/output pair is tested together. The input and the output can be on the same instrument, or alternatively on two different instruments. Given an arbitrary cable connection, the appropriate Tx test can be activated with different interface speeds (LVDS rate).

On the connected input, this test sequence is received and can be compared with the expected test signal.

**Parameters:**

<LRate> float  
 Range: 66E6 to 100E6  
 Increment: 1E6  
 \*RST: 100E6

**Example:**

TEST:BBOut:LRATE 90MHZ  
 sets the LVDS interface rate to 90 MHz

**:TEST<hw>:BBOut:TTEST[:STATe] <State>**

Activates the transmission of a known pseudo-random sequence (On).

**Parameters:**

<State> 0 | 1 | OFF | ON  
 \*RST: 0

**Example:**

TEST:BBO:TTEST:STAT ON  
 starts the transmission of a signal test sequence .

**:TEST:CONNECTor:AUXio?**

The command triggers a test of the AUX IQ interface (see Service Manual Instrument, section "Performance Test"). This function is only available via remote control.

**Example:** TEST:CONN:AUX?

**Usage:** Query only

**:TEST<hw>:DIRect <HW\_assembly>,<subadress>,<hex data string>**  
**:TEST<hw>:DIRect? <HW\_assembly>,<subadress>**

The respective hardware assembly responds directly to the command; any safety mechanisms are bypassed. This function is only available via remote control.

**Example:** TEST:DIR 'SSYN',0,#H12345678  
 TEST:DIR? 'SSYN',0  
 Response: #H12345678

**:TEST:FADer?**

This command performs a selftest on the fading simulator and the hardware options of the fading simulator extension.

**Return values:**

<Fader> 0 | 1 | OFF | ON

**Example:**

TEST:FAD?  
 Response: "0" on success, "1" on fail

**Usage:** Query only

## 7.19 UNIT Subsystem

The UNIT subsystem contains the commands specifying which units are valid if no unit is indicated in a command. These settings are valid for the entire instrument.

---

### **:UNIT:ANGLE** <Angle>

The command defines the default unit for angles. It is valid for all commands which determine angle values. It does not influence the manual operation parameter unit and the display.

#### **Parameters:**

<Angle>                   DEGREE | RADIAN  
\*RST:                    RADIAN

#### **Example:**

UNIT:ANGL DEG  
sets DEG as a default unit for all commands which determine angle values.

---

### **:UNIT:POWER** <Power>

Defines the default unit for power parameters. This setting affects the GUI, as well as all remote control commands that determine power values.

#### **Parameters:**

<Power>                   V | DBUV | DBM  
\*RST:                    DBM

#### **Example:**

UNIT:POW V  
sets V as a default unit for all commands which determine power values.



## 8 Maintenance

The instrument does not need periodic maintenance. Only the cleaning of the instrument is essential. The outside of the instrument is suitably cleaned using a soft, lint-free dust cloth. Make sure that the air vents are not obstructed.

---

### **WARNING**

#### **Shock hazard**

Before cleaning the instrument, make sure that the instrument is switched off and disconnected from all power supplies.

---

### **NOTICE**

#### **Instrument damage caused by cleaning agents**

Cleaning agents contain substances that may damage the instrument. For example, cleaning agents that contain a solvent may damage the front panel labeling, plastic parts, or the display.

Never use cleaning agents such as solvents (thinners, acetone, etc), acids, bases, or other substances.

The outside of the instrument can be cleaned sufficiently using a soft, lint-free dust cloth.

---

Follow the instructions in the service manual and the safety instructions when exchanging modules or ordering spares. The order no. for spare parts is included in the service manual. The service manual includes further information particularly on troubleshooting, repair, exchange of modules and alignment.

The address of our support center and a list of all Rohde & Schwarz service centers can be found at the beginning of this manual.

### 8.1 Storing and Packing

The storage temperature range of the instrument is given in the data sheet. If the instrument is to be stored for a longer period of time, it must be protected against dust.

Repack the instrument as it was originally packed when transporting or shipping. The two protective foam plastic parts prevent the control elements and connectors from being damaged. The antistatic packing foil avoids any undesired electrostatic charging to occur.

If you do not use the original packaging, use a sturdy cardboard box of suitable size and provide for sufficient padding to prevent the instrument from slipping inside the package. Wrap antistatic packing foil around the instrument to protect it from electrostatic charging.



## 9 Status Information, Error Messages and Troubleshooting

The R&S AMU distinguishes between a variety of different messages such as status messages, error messages, warnings, or information that are displayed in the "Info" line on the screen, and also entered in the error/event queue of the status reporting system.

This section describes the information and status messages concerning the operating status of the instrument and the types of error messages and warnings. Some error messages require that the error must be eliminated before correct instrument operation can be ensured. The info window with a list of current messages and a detailed description of each message can be opened with the INFO key.

In the remote control mode, error messages are entered in the error/event queue of the status reporting system and can be queried with the command `SYSTEM:ERROR?`. If the error queue is empty, 0 ("No error") is returned. The status reporting system is described in detail in [Chapter 6.5, "Status Reporting System"](#), on page 415.

Section [Chapter 9.5, "Resolving Network Connection Failures"](#), on page 680 provides recommended solutions for network connection errors, and helps you to collect the information required for quick and efficient support.

### 9.1 Status Information

The status messages are displayed in the header section of the screen. The status information gives the user an overview of the main operating states and settings of the instrument. The states are indicated for information only and do not necessitate any action by the user. Status information is displayed between the frequency and level fields, at the left of the info line or in the info line itself.

On two-path instruments, all states that can occur independently in the two paths are displayed separately for each path. The associated path is indicated in the info line.

#### 9.1.1 Status information displayed between PEP and level fields

This section gives an overview of the status messages displayed between the PEP and level fields.

##### **EXT REF**

An external reference is used.

The external signal with selectable frequency and defined level must be input at the REF IN connector. It is output at the REF OUT connector.

The reference frequency setting is effective for both paths.

**I/Q Out OFF**

The I/Q output is switched off.

**BUSY**

A setting or calculation is executed.

### 9.1.2 Status information displayed to the left of the Info line

This section gives an overview of the status messages displayed to the left of the Info line.

**REMOTE**

Indicates that the instrument is in remote control mode.

The keys on the front panel are usable, but all parameters are in read only mode.

To return to manual control, use the LOCAL key or the command `&GTL`. The current command must be fully processed before the mode is switched, otherwise the instrument switches immediately back to remote control.

**REM-LLO**

Indicates that the instrument is in remote control mode with local lockout enabled.

The LOCAL key is locked. To set the local lockout, use the command `&LLO` (local lockout).

The keys on the front panel are usable, but all parameters are in read only mode.

To return to manual operation or to "REMOTE" state, use one of the following commands:

- `&LOCS`  
switches directly from "REM-LLO" to manual operation.
- `&REMS`  
changes the remote control state from "REM-LLO" to "REMOTE".
- `CALL IBLOC (generator%)` (Visual Basic command)  
switches from remote control state to manual operation.

**LOC-LLO**

For the direct operation the state has been changed from remote control to manual operation (local state). The LOCAL key was disabled with the command `LLO` (local lockout).

With the next activating of the remote control mode, the instrument cannot be switched to manual operation by the operator. The status information changes to "REM-LLO".

The instrument can be switched to manual operation by means of remote control only (e.g. with the Visual Basic command `CALL IBLOC (generator%)`).

**SYS CTRL**

Indicates that the instrument controls another instrument.

## 9.2 Error Messages

Messages indicate errors in the instrument. They are displayed in the info line in different colors depending on their importance and display duration. Errors (e.g. no calibration data) are displayed in red, information (e.g. file not found) and warnings in black. Warnings indicate less significant errors (e.g. the instrument operates outside specified data).

### 9.2.1 Volatile messages

Volatile messages report automatic settings in the instrument (e.g. switching off of incompatible types of modulation) or on illegal entries that are not accepted by the instrument (e.g. range violations). They are displayed in the info line on a yellow background. They are displayed on top of status information or permanent messages.

Volatile messages do not normally demand user actions and disappear automatically after a brief period of time. They are stored in the history, however.

SCPI command: `:SYSTem:ERRor:ALL?` or `:SYSTem:ERRor[:NEXT]?`

### 9.2.2 Permanent messages

Permanent messages are displayed if an error occurs that impairs further instrument operation, e.g. a hardware fault. The error signaled by a permanent message must be eliminated before correct instrument operation can be ensured.

The message is displayed until the error is eliminated. It covers the status display in the info line. After error elimination, the message automatically disappears and is also recorded in the history.

SCPI command: `:SYSTem:SERRor?`

## 9.3 SCPI-Error Messages

The SCPI error messages are the same in all SCPI instruments. Detailed information and an overview of all error messages as defined in SCPI standard can be found in the corresponding documentation.

The errors are assigned negative numbers. The error text being entered into the error/event queue or being displayed is printed in bold face on the left together with the error code. Below the error text, there is an explanation as to the respective error.

## 9.4 Device-Specific Error Messages

The following table contains all error messages specific for the instrument in alphabetical order, as well as an explanation of the error situation. The positive error codes mark the errors specific of the instrument.

The device-specific error messages set bit 3 in the ESR register.



The index provides a list of the error messages sorted according to their error codes.

Error Code	Error	Description	Remedy
50	Extern reference out of range or disconnected	External reference is selected but no external signal is applied or the signal is out of range.	<ul style="list-style-type: none"> <li>Check the selected reference signal source (internal or external) in the "Setup &gt; Reference Oscillator" dialog.</li> <li>Change setting to 'internal' if no appropriate external source is available.</li> </ul>
140	This modulation forces other modulations off	A modulation has been switched on which cannot be used at the same time as an already active modulation. The previous modulation has been switched off. Example: Enabling modulation GSM/EDGE switches any active digital modulation off.	
180	Adjustment failed	Adjustment could not be executed	The adjustment data have to be generated first by an internal or external adjustment or to be loaded into the device (see <a href="#">Chapter 5.2.3.2, "Internal Adjustments"</a> , on page 140).
182	Adjustment data missing	Adjustment data are missing.	The adjustment data have to be generated first by an internal or external adjustment or to be loaded into the instrument.
183	Adjustment data invalid	Adjustment data are invalid and must be restored.	The adjustment data have to be generated again by an internal or external adjustment or to be loaded into the instrument.
200	Cannot access hardware	The data transmission to a module was unsuccessful.	The module is not installed, not properly installed or missing.
201	Hardware revision out of date	A later version of certain parts of the instrument is necessary to execute the function selected.	The driver does not support the installed version of a module.
202	Cannot access the EEPROM	A error occurs when writing or reading a EEPROM.	The EEPROM might be defect and has to be replaced.

Error Code	Error	Description	Remedy
203	Invalid EEPROM data	Reading a EEPROM is possible, however the data are inconsistent.	
204	Driver initialization failed	Initialization of a driver fails when booting the instrument firmware.	The driver is not compatible with the hardware or software configuration of the instrument.
241	No current list	There is no list selected. To execute the required operation, a list has to be selected in the related menu. If no list is available, a new list must be created.	
242	Unknown list type specified	The list type selected is not valid for the required operation.  For instance, the file extension for waveform list files is *.wv. It is not possible to enter another file extension when selecting a list.	Check the selected list type.
261	Waveform Protected	The selected waveform file cannot be transferred to a controller. The waveform is produced with simulation software R&S WinIQSIM2 and is protected.	
460	Cannot open file	The selected file can not be opened.	Check the path and file name.
461	Cannot write file	The file can not be written.	Check if the file is read-only.
462	Cannot read file	The file can not be read.	Check if the file contents are compatible with the file type.
463	Filename missing	The required operation cannot be executed because the file name is not specified.	A file name has to be entered when creating a new list.
464	Invalid filename extension	The file extension is not valid for the required operation.	Check the file extension.  For instance, the file extension for waveform list files is *.wv. It is not possible to enter another file extension when storing a list.
465	File contains invalid data	The selected file contains data that is not valid for the file type.  The file extension determines the data that is valid for this file type. If the file extension is changed the lists are no longer recognized and the data are therefore invalid.  Example: the extension of a waveform file (= *.wv) was changed to *.txt	Check the file extension.

## 9.5 Resolving Network Connection Failures

Several issues may cause failures in the network connection to the instrument. This section lists the most likely reasons and the recommended solutions.

### Common reasons for network connection failures

- Network connecting cables and cable connectors of poor quality
- Incompatibility between the network interface of the R&S AMU and certain switches or routers available on the market
- An invalid IP address assigned to the instrument

### Possible solutions

---

#### **NOTICE**

#### **Risk of connection errors**

Before configuring the network, changing IP addresses or exchanging hardware, consult your network administrator.

Connection errors can affect the entire network.

---

- Check the network infrastructure. Exchange connecting cables if obvious damage is visible.
- Observe the link status LED on the connected network device. The link status LED is located next to the LAN connector.  
If a link failure is detected, connect the instrument to a different device port or to a different network device.
- Check whether the LAN interface is enabled, see "[LAN Connections](#)" on page 160.
- Check whether the IP address of the instrument is within the network's address range.  
IP addresses that are set manually may be invalid.

## 9.6 Obtaining Technical Support

If problems occur, the instrument generates error messages which in most cases will be sufficient for you to detect the cause of an error and find a remedy. Error message types are described in [Chapter 9, "Status Information, Error Messages and Troubleshooting"](#), on page 675.

In addition, our customer support centers are there to assist you in solving any problems that you may encounter with your R&S AMU. We will find solutions more quickly and efficiently if you provide us with the information listed below.

- The following dialog boxes in the "Setup > System" menu provide useful information:
  - **Hardware Configuration:** hardware assemblies



- **Software/Options:** the status of all software and hardware options installed on your instrument
- **System Messages:** displayed in the "Info" line and provide information on any errors that may have occurred

Collect the error information and send an e-mail in which you describe the problem to the customer support address for your region as listed at the beginning of the R&S AMU Getting Started manual.

#### To remove sensitive data

- ▶ For information on how to handle or remove the sensitive data from your instrument, refer to the description "Resolving Security Issues when working with R&S AMU", provided at the product homepage.



#### Packing and transporting the instrument

If the instrument needs to be transported or shipped, e.g. due to damage during delivery, observe the notes described in [Chapter 2.3.2, "Unpacking and Checking the Instrument"](#), on page 34.

---



## Annex

### A Hardware Interfaces

This section covers hardware related topics, like pin assignment of the GPIB bus interface, monitor and AUX I/O connectors.

The remote control interfaces are described in details in [Chapter 6, "Remote Control Basics"](#), on page 381.

All other interfaces are described in [Chapter 2.1, "Front Panel Tour"](#), on page 19 and [Chapter 2.2, "Rear Panel Tour"](#), on page 26.

For specifications refer to the data sheet.

#### A.1 GPIB Bus Interface

##### Pin assignment

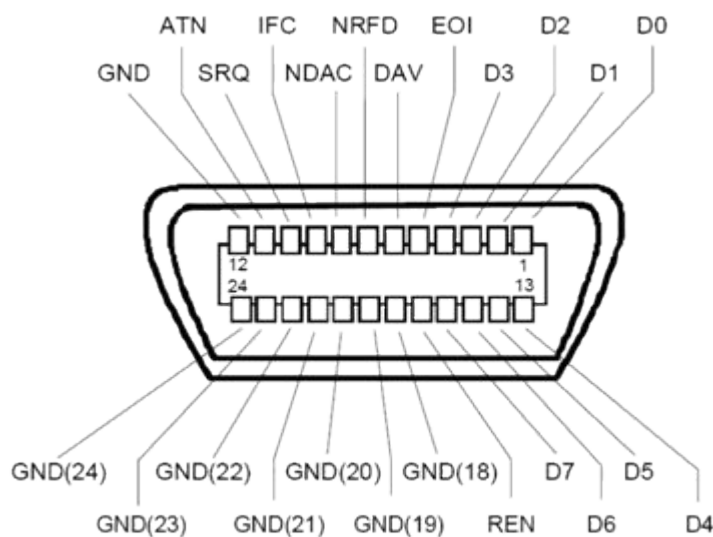

*Figure A-1: Pin assignment of GPIB bus interface*

##### Bus lines

- Data bus with 8 lines D0 to D7:  
The transmission is bit-parallel and byte-serial in the ASCII/ISO code. D0 is the least significant bit, D7 the most significant bit.
- Control bus with five lines:

**IFC** (Interface Clear): active LOW resets the interfaces of the instruments connected to the default setting.

**ATN** (Attention): active LOW signals the transmission of interface messages, inactive HIGH signals the transmission of device messages.

**SRQ** (Service Request): active LOW enables the connected device to send a service request to the controller.

**REN** (Remote Enable): active LOW permits switchover to remote control.

**EOI** (End or Identify): has two functions in connection with ATN:

- ATN=HIGH active LOW marks the end of data transmission.
- ATN=LOW active LOW triggers a parallel poll.

- Handshake bus with three lines:

**DAV** (Data Valid): active LOW signals a valid data byte on the data bus.

**NRFD** (Not Ready For Data): active LOW signals that one of the connected devices is not ready for data transfer.

**NDAC** (Not Data Accepted): active LOW signals that the instrument connected is accepting the data on the data bus.

### Interface Functions

Instruments which can be controlled via GPIB bus can be equipped with different interface functions. The interface function for the R&S AMU are listed in the following table.

**Table A-1: GPIB bus interface functions**

Control character	Interface function
SH1	Handshake source function (source handshake), full capability
AH1	Handshake sink function (acceptor handshake), full capability
L4	Listener function, full capability, de-addressed by MTA.
T6	Talker function, full capability, ability to respond to serial poll, de-addressed by MLA
SR1	Service request function (Service Request), full capability
PP1	Parallel poll function, full capability
RL1	Remote/Local switch over function, full capability
DC1	Reset function (Device Clear), full capability
DT1	Trigger function (Device Trigger), full capability

## A.2 AUX I/O Connector



For an overview of the signals that can be applied at the USER connector, see [Table 5-1](#).

Table A-2: Pin assignment of the AUX I/O Connector connector

Pin	Signal	Description
1 .. 25	Ground $\perp$	Ground
26	FHOP_CLK	Currently, not active, but reserved for future use of the corresponding signal.
27	FHOP_DATA	Currently, not active, but reserved for future use of the corresponding signal.
28	BURST_GATE_A	Currently, not active, but reserved for future use of the corresponding signal.
29 .. 38	PARDATA0 .. PARDATA9	Parallel data input/output 0...D with 10-bit word width for digital modulation. If the data source "External Parallel" is selected, these pins are the data inputs. If a different data source is selected, the data is output here ("Custom Digital Modulation", Path A).
39	USER 3	USER input/output which can be configured for various purposes. The following signals can be applied to the pin: <ul style="list-style-type: none"> <li>• Marker 4 (output path A or path B)</li> <li>• CW Mode Out (output path A or path B)</li> <li>• FHOP_STRB (output path A or B) This signal marks the trigger for frequency hopping by processing of ARB sequences.</li> <li>• Trigger (output path A or path B) This signal marks the trigger event caused by the selected trigger signal (internally or externally) of path A or B. Additional signals for path B are available in two-path instruments. The signals corresponding to path A are applied at the pins of the AUX I/O interface (Clock Out).</li> <li>• Clock Out (output Path B; bit or symbol clock pulse) This signal corresponds to the clock signal for digital modulations.</li> <li>• LEV ATT (input/output path B)</li> <li>• BURST (input/output path B)</li> </ul>
40	USER 4	USER input/output which can be configured for various purposes.
41	BURST	Signal output/input for controlling the burst ramp, path A. With external envelope curve control ("Custom Digital Modulation" only), the pin is the input for the control signal BURST_RAMP. With internal envelope curve control, the control signal BURST_RAMP is output for path A. For two-path instruments, the signal for path B can be applied to one of the user interfaces.
42	MARKER 3 A	Output for the freely programmable marker signal 3 of path A. The output is permanently assigned.
43	MARKER 3 B	Output for the freely programmable marker signal 3 of Path B. The output is permanently assigned.
44	LEV ATT	Signal input/output for controlling the level attenuation. For two-path instruments, the signal for Path B can be applied to one of the USER interfaces. With external envelope curve control ("Custom Digital Modulation" only), the pin is the input for the control signal LEV_ATT. With internal envelope curve control, the control signal LEV_ATT is output for Path A.

Pin	Signal	Description
45	FHOP_STRB	Currently not active, but reserved for future use of the signals
46	BURST_GATE_B	Currently not active, but reserved for future use of the signals
47	BITCLK	Output Bit clock for internal mode. For two-path instruments, the signal for Path B can be applied to one of the USER interfaces.
48	USER 2	USER input/output which can be configured for various purposes.
49	SYMBCLK	Symbol clock output for internal mode. With two-path instruments, the signal for Path B can be applied to one of the USER interfaces.
50	not used	not used

### A.3 Monitor Connector (MONITOR)

The 15-pin Sub-D female connector MONITOR at the rear panel is intended for connecting an external VGA monitor.

*Table A-3: Pin assignment of the MONITOR connector*

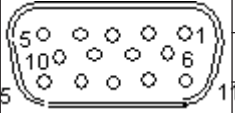
Monitor Connector	Pin	Signal	Pin	Signal	Pin	Signal
	1	Red (output)	6	GND	11	(NC)
	2	Green (output)	7	GND	12	(NC)
	3	Blue (output)	8	GND	13	HSYNC (output)
	4	(NC)	9	GND	14	VSYNC (output)
	5	GND	10	GND	15	(NC)

### A.4 BERT Connector

The 9-pin Sub-D connector BERT at the rear panel is available for the input signals of the integrated bit error rate tester (option BER/BLE Measurement (R&S AMU-K80)).

*Table A-4: Pin assignment of the BERT connector*

Monitor Connector	Pin	Signal	Pin	Signal
	1	GND	6	CLOCK
	2	GND	7	DATA
	3	GND	8	DATA ENABLE
	4	GND	9	RESTART
	5	GND		

The input signals are not terminated in the instrument. The impedance (50 ohm) and the threshold (0.0128..1.998 V) of the inputs can be set in the "BERT" menu.

The following figure shows the circuit diagram of the BERT function.

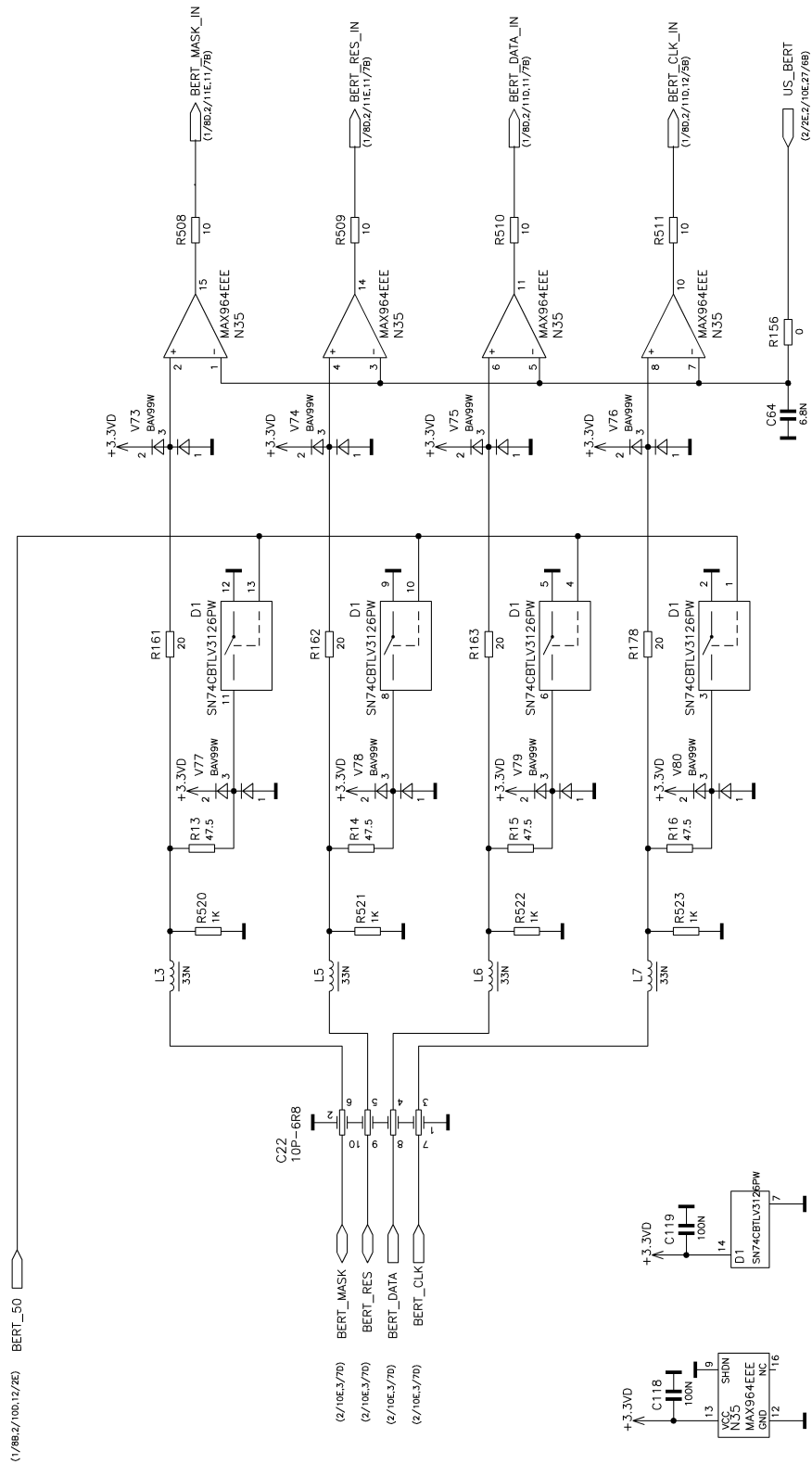

Figure A-2: BERT circuit diagram



## List of Commands

:BERT:RESult?	454
:BERT:SEQuence	456
:BERT:SETup:CLOCK[:POLarity]	456
:BERT:SETup:DATA[:POLarity]	457
:BERT:SETup:DENable	457
:BERT:SETup:IGNore	458
:BERT:SETup:MCOunt	459
:BERT:SETup:MERRor	459
:BERT:SETup:REStart[:STATe]	459
:BERT:SETup:TImeout	460
:BERT:SETup:TYPE	460
:BERT:START	460
:BERT:STATe	461
:BERT:STOP	461
:BERT:UNIT	462
:BLER:RESult?	454
:BLER:SEQuence	456
:BLER:SETup:CLOCK[:POLarity]	456
:BLER:SETup:CORDer	457
:BLER:SETup:DATA[:POLarity]	457
:BLER:SETup:DENable	457
:BLER:SETup:MCOunt	459
:BLER:SETup:MERRor	459
:BLER:SETup:TImeout	460
:BLER:SETup:TYPE	460
:BLER:START	460
:BLER:STATe	461
:BLER:STOP	461
:BLER:UNIT	462
:CALibration<hw>:ALL[:MEASure]?	463
:CALibration<hw>:BBIN[:MEASure]?	464
:CALibration<hw>:DAC[:MEASure]?	464
:CALibration<hw>:ROSCillator[:DATA]	464
:CLOCK:INPut:FREQuency?	465
:CLOCK:INPut:SLOPe	465
:CLOCK:OUTPut:MODE	465
:CLOCK:OUTPut:SOURce	466
:DEvice:PRESet	430
:DIAGnostic:INFO:OTIme?	467
:DIAGnostic:INFO:POCCount?	468
:DIAGnostic<hw>:BGINfo:CATalog?	467
:DIAGnostic<hw>:BGINfo?	466
:DISPlay:ANNotation:AMPLitude	468
:DISPlay:ANNotation:FREQuency	469
:DISPlay:ANNotation[:ALL]	469
:DISPlay:DIALog:CLOSe	469
:DISPlay:DIALog:CLOSe:ALL	469

:DISPlay:DIALog:ID?.....	469
:DISPlay:DIALog:OPEN.....	470
:DISPlay:IQ:OUTPut:LEVel:TYPE?.....	470
:DISPlay:PSAVe:HOLDoff.....	470
:DISPlay:PSAVe[:STATe].....	471
:DISPlay:UPDate.....	471
:FORMat:BORDER.....	471
:FORMat:SREGister.....	472
:FORMat[:DATA].....	472
:HCOPy:DATA?.....	474
:HCOPy:DEVice.....	474
:HCOPy:DEVice:LANGUage.....	474
:HCOPy:FILE[:NAME].....	475
:HCOPy:FILE[:NAME]:AUTO:DIRectory.....	475
:HCOPy:FILE[:NAME]:AUTO:DIRectory:CLear.....	476
:HCOPy:FILE[:NAME]:AUTO:FILE?.....	476
:HCOPy:FILE[:NAME]:AUTO:STATe.....	479
:HCOPy:FILE[:NAME]:AUTO?.....	475
:HCOPy:FILE[:NAME]:AUTO[:FILE]:DAY:STATe.....	477
:HCOPy:FILE[:NAME]:AUTO[:FILE]:DAY?.....	476
:HCOPy:FILE[:NAME]:AUTO[:FILE]:MONTH:STATe.....	477
:HCOPy:FILE[:NAME]:AUTO[:FILE]:MONTH?.....	477
:HCOPy:FILE[:NAME]:AUTO[:FILE]:NUMBer?.....	478
:HCOPy:FILE[:NAME]:AUTO[:FILE]:PREFix.....	478
:HCOPy:FILE[:NAME]:AUTO[:FILE]:PREFix:STATe.....	478
:HCOPy:FILE[:NAME]:AUTO[:FILE]:YEAR:STATe.....	479
:HCOPy:FILE[:NAME]:AUTO[:FILE]:YEAR?.....	479
:HCOPy:IMAGe:FORMat.....	479
:HCOPy:IMAGe:SIZE.....	480
:HCOPy:PRINter:COLor[:STATe].....	480
:HCOPy:PRINter:LIST?.....	480
:HCOPy:PRINter:PAGE:MARGins.....	481
:HCOPy:PRINter:PAGE:ORientation.....	481
:HCOPy:PRINter:PAGE:SIZE.....	482
:HCOPy:PRINter:PAGE:UNIT.....	482
:HCOPy:PRINter[:NAME].....	481
:HCOPy:REGion.....	480
:HCOPy[:EXECute].....	474
:KBOard:LANGUage.....	482
:KBOard:LAYout.....	483
:MEMory:HFRee?.....	491
:MMEMory:CATalog:LENGth?.....	488
:MMEMory:CATalog?.....	488
:MMEMory:CDIRectory.....	489
:MMEMory:COPI.....	489
:MMEMory:DATA.....	490
:MMEMory:DATA:UNPRotected.....	540
:MMEMory:DCATalog:LENGth?.....	491
:MMEMory:DCATalog?.....	490
:MMEMory:DELeTe.....	491

:MMEMory:LOAD:STATe.....	492
:MMEMory:MDIRectory.....	492
:MMEMory:MOVE.....	492
:MMEMory:MSIS.....	493
:MMEMory:RDIRectory.....	493
:MMEMory:STORe:STATe.....	493
:OUTPut:BLANk:POLarity.....	494
:OUTPut:IQ:ALL[:STATe].....	639
:OUTPut:USER<ch>:SOURce.....	494
:SOURce<hw>:PRESet.....	431
:STATus:OPERation:CONDition.....	657
:STATus:OPERation:ENABle.....	657
:STATus:OPERation:NTRansition.....	657
:STATus:OPERation:PTRansition.....	658
:STATus:OPERation[:EVENT].....	657
:STATus:PRESet.....	658
:STATus:QUEStionable:CONDition.....	658
:STATus:QUEStionable:ENABle.....	659
:STATus:QUEStionable:NTRansition.....	659
:STATus:QUEStionable:PTRansition.....	659
:STATus:QUEStionable[:EVENT].....	659
:STATus:QUEue[:NEXT]?.....	660
:SYSTem:BIOS:VERSion?.....	668
:SYSTem:COMMunicate:GPIB:LTERminator.....	663
:SYSTem:COMMunicate:GPIB:RESourcE?.....	664
:SYSTem:COMMunicate:GPIB[:SELF]:ADDReSS.....	663
:SYSTem:COMMunicate:HISLip:RESourcE?.....	665
:SYSTem:COMMunicate:NETWork:RESourcE?.....	665
:SYSTem:COMMunicate:NETWork:REStart.....	664
:SYSTem:COMMunicate:NETWork:STATus?.....	664
:SYSTem:COMMunicate:NETWork[:COMMOn]:WORKgrouP.....	664
:SYSTem:COMMunicate:NETWork[:IPAdDress]:DNS.....	664
:SYSTem:COMMunicate:SOCKeT:RESourcE?.....	665
:SYSTem:DATE.....	667
:SYSTem:DISPlay:UPDate.....	666
:SYSTem:ERRor:ALL?.....	661
:SYSTem:ERRor:CODE:ALL?.....	661
:SYSTem:ERRor:CODE[:NEXT]?.....	662
:SYSTem:ERRor:COUNT?.....	662
:SYSTem:ERRor[:NEXT]?.....	662
:SYSTem:FPReset.....	431
:SYSTem:HCLear.....	667
:SYSTem:MMEMory:PATH:USER?.....	669
:SYSTem:OSYStem?.....	668
:SYSTem:PRESet.....	431
:SYSTem:PROTect<ch>[:STATe].....	666
:SYSTem:SERRor?.....	663
:SYSTem:STARtup:COMPLete?.....	666
:SYSTem:TIME.....	667
:SYSTem:TIME:ZONE.....	668

:SYSTem:TIME:ZONE:CATalog?.....	668
:SYSTem:VERSion?.....	668
:TEST:BB:CONNection?.....	669
:TEST:BBIN?.....	670
:TEST:CONNector:AUXio?.....	671
:TEST:FADer?.....	671
:TEST<hw>:BBIN:RBERror?.....	670
:TEST<hw>:BBOut:LRATe.....	670
:TEST<hw>:BBOut:TTEST[:STATe].....	671
:TEST<hw>:DIRect.....	671
:TRIGger:BERT[:IMMediate].....	463
:TRIGger:BLER[:IMMediate].....	463
:UNIT:ANGLE.....	672
:UNIT:POWer.....	672
[:SOURce]:BB:PATH:COUNT?.....	504
[:SOURce]:INPut:BERT:IMPedance.....	462
[:SOURce]:INPut:BERT:THReshold.....	462
[:SOURce]:INPut:DATA:IMPedance.....	636
[:SOURce]:INPut:DATA:THReshold.....	636
[:SOURce]:INPut:TRIGger:BBANd:SLOPe.....	637
[:SOURce]:INPut:TRIGger:IMPedance.....	637
[:SOURce]:INPut:TRIGger:LEVel.....	638
[:SOURce]:INPut:TRIGger:SLOPe.....	638
[:SOURce]:IQ:OUTPut:DIGital:OFLow:HOLD:RESet.....	650
[:SOURce]:IQ:OUTPut:DIGital:OFLow:HOLD:STATe?.....	650
[:SOURce]:IQ:OUTPut:DIGital:OFLow:STATe?.....	651
[:SOURce]:ROSCillator:EXTernal:FREQuency.....	655
[:SOURce]:ROSCillator:SOURce.....	656
[:SOURce]:ROSCillator[:INTernal]:ADJust:VALue.....	655
[:SOURce]:ROSCillator[:INTernal]:ADJust[:STATe].....	655
[:SOURce<hw>]:AWGN:BRATe.....	496
[:SOURce<hw>]:AWGN:BWIDth.....	496
[:SOURce<hw>]:AWGN:BWIDth:NOISe?.....	497
[:SOURce<hw>]:AWGN:BWIDth:RATio.....	497
[:SOURce<hw>]:AWGN:DISP:ORESults.....	497
[:SOURce<hw>]:AWGN:ENRatio.....	498
[:SOURce<hw>]:AWGN:FREQuency:RESult?.....	498
[:SOURce<hw>]:AWGN:FREQuency:TARGeT.....	499
[:SOURce<hw>]:AWGN:MODE.....	499
[:SOURce<hw>]:AWGN:POWer:CARRier.....	500
[:SOURce<hw>]:AWGN:POWer:MODE.....	500
[:SOURce<hw>]:AWGN:POWer:NOISe.....	501
[:SOURce<hw>]:AWGN:POWer:NOISe:TOTal?.....	501
[:SOURce<hw>]:AWGN:POWer:SUM:PEP?.....	502
[:SOURce<hw>]:AWGN:POWer:SUM?.....	502
[:SOURce<hw>]:AWGN:SNRatio.....	503
[:SOURce<hw>]:AWGN:STATe.....	503
[:SOURce<hw>]:BB:ARBitrary:CLOCK.....	507
[:SOURce<hw>]:BB:ARBitrary:CLOCK:MODE.....	508
[:SOURce<hw>]:BB:ARBitrary:CLOCK:MULTIplier.....	508

[:SOURce<hw>]:BB:ARBitrary:CLOCK:SOURce.....	509
[:SOURce<hw>]:BB:ARBitrary:MCARrier:CARRier:COUNT.....	525
[:SOURce<hw>]:BB:ARBitrary:MCARrier:CARRier:MODE.....	526
[:SOURce<hw>]:BB:ARBitrary:MCARrier:CARRier:SPACing.....	526
[:SOURce<hw>]:BB:ARBitrary:MCARrier:CARRier<ch>:CONFLict?.....	527
[:SOURce<hw>]:BB:ARBitrary:MCARrier:CARRier<ch>:DELay.....	527
[:SOURce<hw>]:BB:ARBitrary:MCARrier:CARRier<ch>:FILE.....	527
[:SOURce<hw>]:BB:ARBitrary:MCARrier:CARRier<ch>:FREQUency.....	527
[:SOURce<hw>]:BB:ARBitrary:MCARrier:CARRier<ch>:PHASe.....	528
[:SOURce<hw>]:BB:ARBitrary:MCARrier:CARRier<ch>:POWer.....	528
[:SOURce<hw>]:BB:ARBitrary:MCARrier:CARRier<ch>:STATe.....	529
[:SOURce<hw>]:BB:ARBitrary:MCARrier:CFACTor:MODE.....	529
[:SOURce<hw>]:BB:ARBitrary:MCARrier:CLIPping:CFACTor.....	529
[:SOURce<hw>]:BB:ARBitrary:MCARrier:CLIPping:CUToff.....	530
[:SOURce<hw>]:BB:ARBitrary:MCARrier:CLIPping[STATe].....	530
[:SOURce<hw>]:BB:ARBitrary:MCARrier:CLoad.....	531
[:SOURce<hw>]:BB:ARBitrary:MCARrier:CLOCK?.....	531
[:SOURce<hw>]:BB:ARBitrary:MCARrier:CREate.....	532
[:SOURce<hw>]:BB:ARBitrary:MCARrier:EDIT:CARRier:DELay:STEP.....	532
[:SOURce<hw>]:BB:ARBitrary:MCARrier:EDIT:CARRier:DELay[:START].....	533
[:SOURce<hw>]:BB:ARBitrary:MCARrier:EDIT:CARRier:EXECute.....	533
[:SOURce<hw>]:BB:ARBitrary:MCARrier:EDIT:CARRier:FILE.....	533
[:SOURce<hw>]:BB:ARBitrary:MCARrier:EDIT:CARRier:PHASe:STEP.....	534
[:SOURce<hw>]:BB:ARBitrary:MCARrier:EDIT:CARRier:PHASe[:START].....	534
[:SOURce<hw>]:BB:ARBitrary:MCARrier:EDIT:CARRier:POWer:STEP.....	534
[:SOURce<hw>]:BB:ARBitrary:MCARrier:EDIT:CARRier:POWer[:START].....	535
[:SOURce<hw>]:BB:ARBitrary:MCARrier:EDIT:CARRier:START.....	535
[:SOURce<hw>]:BB:ARBitrary:MCARrier:EDIT:CARRier:STATe.....	536
[:SOURce<hw>]:BB:ARBitrary:MCARrier:EDIT:CARRier:STOP.....	535
[:SOURce<hw>]:BB:ARBitrary:MCARrier:OFILe.....	536
[:SOURce<hw>]:BB:ARBitrary:MCARrier:POWer:REFerence.....	528
[:SOURce<hw>]:BB:ARBitrary:MCARrier:PRESet.....	536
[:SOURce<hw>]:BB:ARBitrary:MCARrier:SAMPles?.....	536
[:SOURce<hw>]:BB:ARBitrary:MCARrier:SETTing:CATalog?.....	537
[:SOURce<hw>]:BB:ARBitrary:MCARrier:SETTing:LOAD.....	537
[:SOURce<hw>]:BB:ARBitrary:MCARrier:SETTing:STORE.....	537
[:SOURce<hw>]:BB:ARBitrary:MCARrier:SETTing:STORE:FAST.....	538
[:SOURce<hw>]:BB:ARBitrary:MCARrier:TIME.....	538
[:SOURce<hw>]:BB:ARBitrary:MCARrier:TIME:MODE.....	538
[:SOURce<hw>]:BB:ARBitrary:PRESet.....	507
[:SOURce<hw>]:BB:ARBitrary:STATe.....	507
[:SOURce<hw>]:BB:ARBitrary:TRIGger:ARM:EXECute.....	510
[:SOURce<hw>]:BB:ARBitrary:TRIGger:DELay:UNIT.....	516
[:SOURce<hw>]:BB:ARBitrary:TRIGger:EXECute.....	510
[:SOURce<hw>]:BB:ARBitrary:TRIGger:OBASeband:DELay.....	511
[:SOURce<hw>]:BB:ARBitrary:TRIGger:OBASeband:INHibit.....	512
[:SOURce<hw>]:BB:ARBitrary:TRIGger:OBASeband:RDELay?.....	511
[:SOURce<hw>]:BB:ARBitrary:TRIGger:OBASeband:TDELay.....	512
[:SOURce<hw>]:BB:ARBitrary:TRIGger:OUTPut:DELay:FIXed.....	512
[:SOURce<hw>]:BB:ARBitrary:TRIGger:OUTPut<ch>:DELay.....	513

[:SOURce<hw>]:BB:ARBitrary:TRIGger:OUTPut<ch>:DELay:MAXimum?	513
[:SOURce<hw>]:BB:ARBitrary:TRIGger:OUTPut<ch>:DELay:MINimum?	513
[:SOURce<hw>]:BB:ARBitrary:TRIGger:OUTPut<ch>:MODE	518
[:SOURce<hw>]:BB:ARBitrary:TRIGger:OUTPut<ch>:OFFTime	519
[:SOURce<hw>]:BB:ARBitrary:TRIGger:OUTPut<ch>:ONTTime	519
[:SOURce<hw>]:BB:ARBitrary:TRIGger:OUTPut<ch>:PATTern	520
[:SOURce<hw>]:BB:ARBitrary:TRIGger:OUTPut<ch>:PULSe:DIVider	520
[:SOURce<hw>]:BB:ARBitrary:TRIGger:OUTPut<ch>:PULSe:FREQuency?	520
[:SOURce<hw>]:BB:ARBitrary:TRIGger:RMODE?	514
[:SOURce<hw>]:BB:ARBitrary:TRIGger:SLENGth	514
[:SOURce<hw>]:BB:ARBitrary:TRIGger:SLUNit	515
[:SOURce<hw>]:BB:ARBitrary:TRIGger:SMODE	515
[:SOURce<hw>]:BB:ARBitrary:TRIGger:SOURce	515
[:SOURce<hw>]:BB:ARBitrary:TRIGger[:EXTernal]:SYNChronize:OUTPut	510
[:SOURce<hw>]:BB:ARBitrary:TRIGger[:EXTernal<1 2>]:DELay	516
[:SOURce<hw>]:BB:ARBitrary:TRIGger[:EXTernal<1 2>]:INHibit	517
[:SOURce<hw>]:BB:ARBitrary:TRIGger[:EXTernal<1 2>]:RDELay?	516
[:SOURce<hw>]:BB:ARBitrary:TRIGger[:EXTernal<1 2>]:TDELay	516
[:SOURce<hw>]:BB:ARBitrary:TSIGnal:CIQ:CREate	521
[:SOURce<hw>]:BB:ARBitrary:TSIGnal:CIQ:CREate:NAMed	521
[:SOURce<hw>]:BB:ARBitrary:TSIGnal:CIQ:I	522
[:SOURce<hw>]:BB:ARBitrary:TSIGnal:CIQ:Q	522
[:SOURce<hw>]:BB:ARBitrary:TSIGnal:RECTangle:AMPliTude	522
[:SOURce<hw>]:BB:ARBitrary:TSIGnal:RECTangle:CREate	521
[:SOURce<hw>]:BB:ARBitrary:TSIGnal:RECTangle:CREate:NAMed	521
[:SOURce<hw>]:BB:ARBitrary:TSIGnal:RECTangle:FREQuency	522
[:SOURce<hw>]:BB:ARBitrary:TSIGnal:RECTangle:OFFSet	523
[:SOURce<hw>]:BB:ARBitrary:TSIGnal:RECTangle:SAMPles	523
[:SOURce<hw>]:BB:ARBitrary:TSIGnal:SINE:CREate	521
[:SOURce<hw>]:BB:ARBitrary:TSIGnal:SINE:CREate:NAMed	521
[:SOURce<hw>]:BB:ARBitrary:TSIGnal:SINE:FREQuency	523
[:SOURce<hw>]:BB:ARBitrary:TSIGnal:SINE:PHASe	524
[:SOURce<hw>]:BB:ARBitrary:TSIGnal:SINE:SAMPles	524
[:SOURce<hw>]:BB:ARBitrary:WAVEform:CATalog:LENGth?	540
[:SOURce<hw>]:BB:ARBitrary:WAVEform:CATalog?	539
[:SOURce<hw>]:BB:ARBitrary:WAVEform:CLOCK	541
[:SOURce<hw>]:BB:ARBitrary:WAVEform:DATA	542
[:SOURce<hw>]:BB:ARBitrary:WAVEform:DELeTe	543
[:SOURce<hw>]:BB:ARBitrary:WAVEform:FREE?	543
[:SOURce<hw>]:BB:ARBitrary:WAVEform:HDDStreaming:BLEVel?	543
[:SOURce<hw>]:BB:ARBitrary:WAVEform:HDDStreaming:STATe	544
[:SOURce<hw>]:BB:ARBitrary:WAVEform:POINts?	544
[:SOURce<hw>]:BB:ARBitrary:WAVEform:SELEct	545
[:SOURce<hw>]:BB:ARBitrary:WAVEform:TAG?	545
[:SOURce<hw>]:BB:ARBitrary:WSEGment:CLOAd	546
[:SOURce<hw>]:BB:ARBitrary:WSEGment:CONFigure:BLANK:APPend	547
[:SOURce<hw>]:BB:ARBitrary:WSEGment:CONFigure:CATalog?	548
[:SOURce<hw>]:BB:ARBitrary:WSEGment:CONFigure:CLOCK	548
[:SOURce<hw>]:BB:ARBitrary:WSEGment:CONFigure:CLOCK:MODE	548
[:SOURce<hw>]:BB:ARBitrary:WSEGment:CONFigure:COMMeNt	549

[[:SOURce<hw>]:BB:ARBitrary:WSEgment:CONFigure:DELeTe.....	549
[[:SOURce<hw>]:BB:ARBitrary:WSEgment:CONFigure:LEVel[:MODE].....	549
[[:SOURce<hw>]:BB:ARBitrary:WSEgment:CONFigure:MARKer:ESEgment.....	550
[[:SOURce<hw>]:BB:ARBitrary:WSEgment:CONFigure:MARKer:FSEgment.....	550
[[:SOURce<hw>]:BB:ARBitrary:WSEgment:CONFigure:MARKer:MODE.....	551
[[:SOURce<hw>]:BB:ARBitrary:WSEgment:CONFigure:OFILe.....	551
[[:SOURce<hw>]:BB:ARBitrary:WSEgment:CONFigure:SEGment:APPend.....	552
[[:SOURce<hw>]:BB:ARBitrary:WSEgment:CONFigure:SEGment:CATalog?.....	552
[[:SOURce<hw>]:BB:ARBitrary:WSEgment:CONFigure:SELEct.....	552
[[:SOURce<hw>]:BB:ARBitrary:WSEgment:CREate.....	553
[[:SOURce<hw>]:BB:ARBitrary:WSEgment:NAME?.....	553
[[:SOURce<hw>]:BB:ARBitrary:WSEgment:NEXT.....	554
[[:SOURce<hw>]:BB:ARBitrary:WSEgment:NEXT:EXECute.....	554
[[:SOURce<hw>]:BB:ARBitrary:WSEgment:NEXT:SOURce?.....	554
[[:SOURce<hw>]:BB:ARBitrary:WSEgment:SEQuence:APPend.....	555
[[:SOURce<hw>]:BB:ARBitrary:WSEgment:SEQuence:SELEct.....	555
[[:SOURce<hw>]:BB:ARBitrary:WSEgment?.....	546
[[:SOURce<hw>]:BB:ARBitrary[:TRIGger]:SEQuence.....	517
[[:SOURce<hw>]:BB:CFACtor?.....	625
[[:SOURce<hw>]:BB:DM:AQPSk:ANGLE.....	577
[[:SOURce<hw>]:BB:DM:ASK:DEPTh.....	577
[[:SOURce<hw>]:BB:DM:CLISt:CATalog?.....	584
[[:SOURce<hw>]:BB:DM:CLISt:COPIY.....	585
[[:SOURce<hw>]:BB:DM:CLISt:DATA.....	586
[[:SOURce<hw>]:BB:DM:CLISt:DELeTe.....	587
[[:SOURce<hw>]:BB:DM:CLISt:FREE?.....	584
[[:SOURce<hw>]:BB:DM:CLISt:POINts?.....	587
[[:SOURce<hw>]:BB:DM:CLISt:SELEct.....	587
[[:SOURce<hw>]:BB:DM:CLISt:TAG?.....	585
[[:SOURce<hw>]:BB:DM:CLOCK:MODE.....	560
[[:SOURce<hw>]:BB:DM:CLOCK:MULTIplier.....	561
[[:SOURce<hw>]:BB:DM:CLOCK:SOURce.....	561
[[:SOURce<hw>]:BB:DM:CODing.....	577
[[:SOURce<hw>]:BB:DM:DLISt:CATalog?.....	584
[[:SOURce<hw>]:BB:DM:DLISt:COPIY.....	585
[[:SOURce<hw>]:BB:DM:DLISt:DATA.....	588
[[:SOURce<hw>]:BB:DM:DLISt:DATA:APPend.....	589
[[:SOURce<hw>]:BB:DM:DLISt:DELeTe.....	589
[[:SOURce<hw>]:BB:DM:DLISt:FREE?.....	584
[[:SOURce<hw>]:BB:DM:DLISt:POINts.....	589
[[:SOURce<hw>]:BB:DM:DLISt:SELEct.....	590
[[:SOURce<hw>]:BB:DM:DLISt:TAG?.....	585
[[:SOURce<hw>]:BB:DM:FILTer:OSAMpling.....	574
[[:SOURce<hw>]:BB:DM:FILTer:OSAMpling:AUTO.....	574
[[:SOURce<hw>]:BB:DM:FILTer:PARAmeter:APCO25.....	574
[[:SOURce<hw>]:BB:DM:FILTer:PARAmeter:APCO25Lsm:GAUSSs.....	576
[[:SOURce<hw>]:BB:DM:FILTer:PARAmeter:APCO25Lsm:LOWPass.....	576
[[:SOURce<hw>]:BB:DM:FILTer:PARAmeter:COSSine:BANDwidth.....	575
[[:SOURce<hw>]:BB:DM:FILTer:PARAmeter:COSSine[:ROLLoff].....	574
[[:SOURce<hw>]:BB:DM:FILTer:PARAmeter:GAUSSs.....	574

[:SOURce<hw>]:BB:DM:FILTer:PARAmeter:LPASs.....	574
[:SOURce<hw>]:BB:DM:FILTer:PARAmeter:LPASSEVM.....	574
[:SOURce<hw>]:BB:DM:FILTer:PARAmeter:PGAuss.....	574
[:SOURce<hw>]:BB:DM:FILTer:PARAmeter:RCOSine.....	574
[:SOURce<hw>]:BB:DM:FILTer:PARAmeter:SPHase.....	574
[:SOURce<hw>]:BB:DM:FILTer:TYPE.....	576
[:SOURce<hw>]:BB:DM:FLISt:CATalog?.....	584
[:SOURce<hw>]:BB:DM:FLISt:DELeTe.....	590
[:SOURce<hw>]:BB:DM:FLISt:FREE?.....	584
[:SOURce<hw>]:BB:DM:FLISt:POINts?.....	591
[:SOURce<hw>]:BB:DM:FLISt:SELeCt.....	591
[:SOURce<hw>]:BB:DM:FORMat.....	578
[:SOURce<hw>]:BB:DM:FSK:DEVIation.....	578
[:SOURce<hw>]:BB:DM:FSK:VARiable:SYMBol<ch0>:DEVIation.....	579
[:SOURce<hw>]:BB:DM:FSK:VARiable:TYPE.....	579
[:SOURce<hw>]:BB:DM:MDElay?.....	580
[:SOURce<hw>]:BB:DM:MLISt:CATalog?.....	584
[:SOURce<hw>]:BB:DM:MLISt:DELeTe.....	591
[:SOURce<hw>]:BB:DM:MLISt:FREE?.....	584
[:SOURce<hw>]:BB:DM:MLISt:POINts?.....	592
[:SOURce<hw>]:BB:DM:MLISt:SELeCt.....	592
[:SOURce<hw>]:BB:DM:PATTern.....	556
[:SOURce<hw>]:BB:DM:PRAMp:ATTenuation.....	580
[:SOURce<hw>]:BB:DM:PRAMp:FDElay.....	581
[:SOURce<hw>]:BB:DM:PRAMp:RDElay.....	581
[:SOURce<hw>]:BB:DM:PRAMp:SHAPE.....	581
[:SOURce<hw>]:BB:DM:PRAMp:SOURce.....	581
[:SOURce<hw>]:BB:DM:PRAMp:TIME.....	582
[:SOURce<hw>]:BB:DM:PRAMp[.STATe].....	582
[:SOURce<hw>]:BB:DM:PRBS[.LENGth].....	557
[:SOURce<hw>]:BB:DM:PRESet.....	557
[:SOURce<hw>]:BB:DM:SETTing:CATalog?.....	592
[:SOURce<hw>]:BB:DM:SETTing:DELeTe.....	593
[:SOURce<hw>]:BB:DM:SETTing:LOAD.....	593
[:SOURce<hw>]:BB:DM:SETTing:STORe.....	593
[:SOURce<hw>]:BB:DM:SETTing:STORe:FAST.....	594
[:SOURce<hw>]:BB:DM:SOURce.....	557
[:SOURce<hw>]:BB:DM:SRATe.....	558
[:SOURce<hw>]:BB:DM:STANdard.....	559
[:SOURce<hw>]:BB:DM:STANdard:ULISt:CATalog?.....	594
[:SOURce<hw>]:BB:DM:STANdard:ULISt:DELeTe.....	594
[:SOURce<hw>]:BB:DM:STANdard:ULISt:LOAD.....	595
[:SOURce<hw>]:BB:DM:STANdard:ULISt:STORe.....	595
[:SOURce<hw>]:BB:DM:STATe.....	559
[:SOURce<hw>]:BB:DM:SWITChing:SOURce.....	559
[:SOURce<hw>]:BB:DM:SWITChing:STATe.....	560
[:SOURce<hw>]:BB:DM:TRIGGer:ARM:EXECute.....	562
[:SOURce<hw>]:BB:DM:TRIGGer:DElay:UNIT.....	568
[:SOURce<hw>]:BB:DM:TRIGGer:EXECute.....	563
[:SOURce<hw>]:BB:DM:TRIGGer:EXTernal:SYNChronize:OUTPut.....	563



[SOURce<hw>]:BB:DM:TRIGger:OBASeband:DElay.....	564
[SOURce<hw>]:BB:DM:TRIGger:OBASeband:INHibit.....	565
[SOURce<hw>]:BB:DM:TRIGger:OBASeband:RDElay?.....	564
[SOURce<hw>]:BB:DM:TRIGger:OBASeband:TDElay.....	565
[SOURce<hw>]:BB:DM:TRIGger:OUTPut:DElay:FIXed.....	566
[SOURce<hw>]:BB:DM:TRIGger:OUTPut<ch>:DElay.....	566
[SOURce<hw>]:BB:DM:TRIGger:OUTPut<ch>:DElay:MAXimum?.....	566
[SOURce<hw>]:BB:DM:TRIGger:OUTPut<ch>:DElay:MINimum?.....	566
[SOURce<hw>]:BB:DM:TRIGger:OUTPut<ch>:MODE.....	571
[SOURce<hw>]:BB:DM:TRIGger:OUTPut<ch>:OFFTime.....	571
[SOURce<hw>]:BB:DM:TRIGger:OUTPut<ch>:ONTime.....	572
[SOURce<hw>]:BB:DM:TRIGger:OUTPut<ch>:PATTern.....	572
[SOURce<hw>]:BB:DM:TRIGger:OUTPut<ch>:PULSe:DIVider.....	572
[SOURce<hw>]:BB:DM:TRIGger:OUTPut<ch>:PULSe:FREQUency?.....	573
[SOURce<hw>]:BB:DM:TRIGger:RMODE?.....	567
[SOURce<hw>]:BB:DM:TRIGger:SLENgth.....	567
[SOURce<hw>]:BB:DM:TRIGger:SOURce.....	568
[SOURce<hw>]:BB:DM:TRIGger[EXTErnal]:RDElay?.....	569
[SOURce<hw>]:BB:DM:TRIGger[EXTErnal]:TDElay.....	569
[SOURce<hw>]:BB:DM:TRIGger[EXTErnal<ch>]:DElay.....	568
[SOURce<hw>]:BB:DM:TRIGger[EXTErnal<ch>]:INHibit.....	569
[SOURce<hw>]:BB:DM[TRIGger]:SEQUence.....	570
[SOURce<hw>]:BB:FOFFset.....	505
[SOURce<hw>]:BB:GRAPhics:MODE.....	595
[SOURce<hw>]:BB:GRAPhics:SMARt:STATe.....	596
[SOURce<hw>]:BB:GRAPhics:SRATe:MODE.....	596
[SOURce<hw>]:BB:GRAPhics:SRATe:USER.....	597
[SOURce<hw>]:BB:GRAPhics:STATe.....	597
[SOURce<hw>]:BB:GRAPhics:TRIGger:SOURce.....	597
[SOURce<hw>]:BB:IMPairment:IQRatio[MAGNitude].....	598
[SOURce<hw>]:BB:IMPairment:LEAKage:I.....	599
[SOURce<hw>]:BB:IMPairment:LEAKage:Q.....	599
[SOURce<hw>]:BB:IMPairment:QUADrature[ANGLE].....	600
[SOURce<hw>]:BB:IMPairment:STATe.....	600
[SOURce<hw>]:BB:MCCW:CARRier:COUNT.....	602
[SOURce<hw>]:BB:MCCW:CARRier:LIST:PHASe.....	602
[SOURce<hw>]:BB:MCCW:CARRier:LIST:POWER.....	603
[SOURce<hw>]:BB:MCCW:CARRier:LIST:STATe.....	604
[SOURce<hw>]:BB:MCCW:CARRier:PHASe.....	604
[SOURce<hw>]:BB:MCCW:CARRier:POWER.....	605
[SOURce<hw>]:BB:MCCW:CARRier:SPACing.....	605
[SOURce<hw>]:BB:MCCW:CARRier:STATe.....	605
[SOURce<hw>]:BB:MCCW:CFACTOR.....	606
[SOURce<hw>]:BB:MCCW:CFACTOR:ACTual?.....	606
[SOURce<hw>]:BB:MCCW:CFACTOR:MODE.....	606
[SOURce<hw>]:BB:MCCW:CLOCK:MODE.....	620
[SOURce<hw>]:BB:MCCW:CLOCK:MULTIplier.....	620
[SOURce<hw>]:BB:MCCW:CLOCK:SOURce.....	621
[SOURce<hw>]:BB:MCCW:CLOCK?.....	607
[SOURce<hw>]:BB:MCCW:EDIT:CARRier:EXECute.....	607

[:SOURce<hw>]:BB:MCCW:EDIT:CARRier:PHASe:STEP.....	608
[:SOURce<hw>]:BB:MCCW:EDIT:CARRier:PHASe[:START].....	608
[:SOURce<hw>]:BB:MCCW:EDIT:CARRier:POWer:STEP.....	609
[:SOURce<hw>]:BB:MCCW:EDIT:CARRier:POWer[:START].....	609
[:SOURce<hw>]:BB:MCCW:EDIT:CARRier:START.....	610
[:SOURce<hw>]:BB:MCCW:EDIT:CARRier:STATe.....	610
[:SOURce<hw>]:BB:MCCW:EDIT:CARRier:STOP.....	610
[:SOURce<hw>]:BB:MCCW:PRESet.....	601
[:SOURce<hw>]:BB:MCCW:STATe.....	601
[:SOURce<hw>]:BB:MCCW:TRIGger:ARM:EXECute.....	611
[:SOURce<hw>]:BB:MCCW:TRIGger:EXECute.....	611
[:SOURce<hw>]:BB:MCCW:TRIGger:EXTernal:SYNChronize:OUTPut.....	611
[:SOURce<hw>]:BB:MCCW:TRIGger:OBASeband:DELay.....	612
[:SOURce<hw>]:BB:MCCW:TRIGger:OBASeband:INHibit.....	612
[:SOURce<hw>]:BB:MCCW:TRIGger:OUTPut:DELay:FIXed.....	616
[:SOURce<hw>]:BB:MCCW:TRIGger:OUTPut<ch>:DELay.....	616
[:SOURce<hw>]:BB:MCCW:TRIGger:OUTPut<ch>:DELay:MAXimum?.....	617
[:SOURce<hw>]:BB:MCCW:TRIGger:OUTPut<ch>:DELay:MINimum?.....	617
[:SOURce<hw>]:BB:MCCW:TRIGger:OUTPut<ch>:MODE.....	618
[:SOURce<hw>]:BB:MCCW:TRIGger:OUTPut<ch>:OFFTime.....	618
[:SOURce<hw>]:BB:MCCW:TRIGger:OUTPut<ch>:ONTime.....	618
[:SOURce<hw>]:BB:MCCW:TRIGger:OUTPut<ch>:PATTern.....	619
[:SOURce<hw>]:BB:MCCW:TRIGger:OUTPut<ch>:PULSe:DIVider.....	619
[:SOURce<hw>]:BB:MCCW:TRIGger:OUTPut<ch>:PULSe:FREQuency?.....	619
[:SOURce<hw>]:BB:MCCW:TRIGger:RMODE?.....	613
[:SOURce<hw>]:BB:MCCW:TRIGger:SLENgth.....	613
[:SOURce<hw>]:BB:MCCW:TRIGger:SOURce.....	614
[:SOURce<hw>]:BB:MCCW:TRIGger[:EXTernal<ch>]:DELay.....	614
[:SOURce<hw>]:BB:MCCW:TRIGger[:EXTernal<ch>]:INHibit.....	614
[:SOURce<hw>]:BB:MCCW[:TRIGger]:SEQuence.....	615
[:SOURce<hw>]:BB:MEASurement:CFACTOR?.....	621
[:SOURce<hw>]:BB:MEASurement:DURation.....	622
[:SOURce<hw>]:BB:MEASurement:POWer:PEAK?.....	622
[:SOURce<hw>]:BB:MEASurement:POWer:RMS?.....	623
[:SOURce<hw>]:BB:MEASurement:RTIME?.....	623
[:SOURce<hw>]:BB:MEASurement:SOURce.....	623
[:SOURce<hw>]:BB:MEASurement[:STATe].....	624
[:SOURce<hw>]:BB:MFPCorrection?.....	624
[:SOURce<hw>]:BB:PGAin.....	505
[:SOURce<hw>]:BB:POFFset.....	505
[:SOURce<hw>]:BB:POWer:PEAK?.....	625
[:SOURce<hw>]:BB:POWer:RMS?.....	626
[:SOURce<hw>]:BB:PROGress:MCODer:ARBITrary:MCARrier?.....	627
[:SOURce<hw>]:BB:PROGress:MCODer:ARBITrary:WSEGment?.....	627
[:SOURce<hw>]:BB:PROGress:MCODer:DM:FILTer?.....	627
[:SOURce<hw>]:BB:PROGress:MCODer?.....	627
[:SOURce<hw>]:BB:ROUte.....	506
[:SOURce<hw>]:BBIN:ALEVel:EXECute.....	628
[:SOURce<hw>]:BBIN:CDEVice?.....	628
[:SOURce<hw>]:BBIN:CFACTOR.....	629

[[:SOURce<hw>]:BBIN:DIGital:ASETting:STATe.....	629
[[:SOURce<hw>]:BBIN:FOFFset.....	629
[[:SOURce<hw>]:BBIN:GIMBalance.....	630
[[:SOURce<hw>]:BBIN:IQSWap[:STATe].....	630
[[:SOURce<hw>]:BBIN:MODE.....	630
[[:SOURce<hw>]:BBIN:MPERiod.....	631
[[:SOURce<hw>]:BBIN:OFFSet:I.....	631
[[:SOURce<hw>]:BBIN:OFFSet:Q.....	631
[[:SOURce<hw>]:BBIN:OLOad:HOLD:RESet.....	631
[[:SOURce<hw>]:BBIN:OLOad:HOLD:STATe?.....	632
[[:SOURce<hw>]:BBIN:OLOad:STATe?.....	632
[[:SOURce<hw>]:BBIN:PGAin.....	632
[[:SOURce<hw>]:BBIN:POWer:PEAK.....	633
[[:SOURce<hw>]:BBIN:POWer:RMS?.....	633
[[:SOURce<hw>]:BBIN:ROUte.....	633
[[:SOURce<hw>]:BBIN:SKEW.....	634
[[:SOURce<hw>]:BBIN:SRATe:FIFO[:STATus]?.....	635
[[:SOURce<hw>]:BBIN:SRATe:SOURce.....	635
[[:SOURce<hw>]:BBIN:SRATe[:ACTual]?.....	634
[[:SOURce<hw>]:BBIN:STATe.....	635
[[:SOURce<hw>]:DM:FILTer:PARAmeter.....	576
[[:SOURce<hw>]:IQ:OUTPut:ANALog:STATe.....	648
[[:SOURce<hw>]:IQ:OUTPut:DIGital:CDEvice?.....	649
[[:SOURce<hw>]:IQ:OUTPut:DIGital:CFS?.....	649
[[:SOURce<hw>]:IQ:OUTPut:DIGital:CFSN?.....	649
[[:SOURce<hw>]:IQ:OUTPut:DIGital:ILOSs?.....	650
[[:SOURce<hw>]:IQ:OUTPut:DIGital:PON.....	651
[[:SOURce<hw>]:IQ:OUTPut:DIGital:POWer:LEVel.....	651
[[:SOURce<hw>]:IQ:OUTPut:DIGital:POWer:PEP.....	651
[[:SOURce<hw>]:IQ:OUTPut:DIGital:POWer:STEP:MODE.....	652
[[:SOURce<hw>]:IQ:OUTPut:DIGital:POWer:STEP[:INCRement].....	652
[[:SOURce<hw>]:IQ:OUTPut:DIGital:SRATe.....	653
[[:SOURce<hw>]:IQ:OUTPut:DIGital:SRATe:FIFO[:STATus]?.....	653
[[:SOURce<hw>]:IQ:OUTPut:DIGital:SRATe:SOURce.....	653
[[:SOURce<hw>]:IQ:OUTPut:DIGital:STATe.....	654
[[:SOURce<hw>]:IQ:OUTPut:DISPlay.....	639
[[:SOURce<hw>]:IQ:OUTPut:DISPlay:AINFormation.....	640
[[:SOURce<hw>]:IQ:OUTPut:POWer:VIA.....	640
[[:SOURce<hw>]:IQ:OUTPut:STATe.....	641
[[:SOURce<hw>]:IQ:OUTPut:SWAP[:STATe].....	641
[[:SOURce<hw>]:IQ:OUTPut[:ANALog]:BIAS:COUPling[:STATe].....	642
[[:SOURce<hw>]:IQ:OUTPut[:ANALog]:BIAS:I.....	642
[[:SOURce<hw>]:IQ:OUTPut[:ANALog]:BIAS:Q.....	642
[[:SOURce<hw>]:IQ:OUTPut[:ANALog]:CFS?.....	643
[[:SOURce<hw>]:IQ:OUTPut[:ANALog]:CFSN?.....	644
[[:SOURce<hw>]:IQ:OUTPut[:ANALog]:ILOSs?.....	644
[[:SOURce<hw>]:IQ:OUTPut[:ANALog]:LOAD.....	644
[[:SOURce<hw>]:IQ:OUTPut[:ANALog]:OFFSet:I.....	643
[[:SOURce<hw>]:IQ:OUTPut[:ANALog]:OFFSet:Q.....	643
[[:SOURce<hw>]:IQ:OUTPut[:ANALog]:PON.....	645

[ :SOURce<hw>]:IQ:OUTPut[:ANALog]:POWer:LEVel.....	645
[ :SOURce<hw>]:IQ:OUTPut[:ANALog]:POWer:PEP.....	646
[ :SOURce<hw>]:IQ:OUTPut[:ANALog]:POWer:PEP:RESult?.....	646
[ :SOURce<hw>]:IQ:OUTPut[:ANALog]:POWer:STEP:MODE.....	647
[ :SOURce<hw>]:IQ:OUTPut[:ANALog]:POWer:STEP[:INCRement].....	647
[ :SOURce<hw>]:IQ:OUTPut[:ANALog]:TYPE.....	648
{[TRACE] LIST [#]: Pos0:State0; Pos1:State1; ...PosN-1:StateN-1}.....	439
{CLOCK: frequency}.....	434
{COMMENT: string}.....	434
{CONTROL LENGTH: ControlLength}.....	437
{CONTROL LIST WIDTH4-Length: #m0m1...mx...mM-1}.....	444
{COPYRIGHT: string}.....	435
{DATA BITLENGTH: BitLength}.....	435
{DATA LIST-Length: #d0d1...dx...dN-1...}.....	435
{DATE: yyyy-mm-dd;hh:mm:ss}.....	436
{EMPTYTAG-Length: #EmptySequence}.....	436
{LEVEL OFFS: RMSOffset_dB,PeakOffset_dB}.....	438
{MWV_SEGMENT_CLOCK_MODE: Mode}.....	442
{MWV_SEGMENT_CLOCK: ClockSeg0, ClockSeg1, ..., ClockSegN-1}.....	443
{MWV_SEGMENT_COUNT: NumOfSeg}.....	441
{MWV_SEGMENT_FILES: "FileNameSeg0.wv", "FileNameSeg1.wv", ..., "FileNameSegN-1.wv"}.....	444
{MWV_SEGMENT_LENGTH: SamplesSeg0, SamplesSeg1, ..., SamplesSegN-1}.....	442
{MWV_SEGMENT_LEVEL_OFFS: RMSOffs_dBSg0,PeakOffs_dBSg0, ..., RMSOffs_dBSgN-1, PeakOffs_dBSgN-1}.....	444
{MWV_SEGMENT_START: SampleStartOffsetSeg0, SampleStartOffsetSeg1, ..., SampleStartOffsetSegN-1}.....	442
{MWV_SEGMENTx_COMMENT: text}.....	444
{SAMPLES: Samples}.....	439
{TYPE: magic, xxxxxxxx}.....	433
{WAVEFORM-Length: #IQ0I1Q1...IxQx...IN-1QN-1...}.....	440
*CLS.....	426
*ESE.....	426
*ESR?.....	426
*IDN?.....	427
*IST?.....	427
*OPC.....	427
*OPT?.....	427
*PRE.....	428
*PSC.....	428
*RCL.....	428
*RST.....	428
*SAV.....	429
*SRE.....	429
*STB?.....	429
*TRG.....	429
*TST?.....	429
*WAI.....	430

# Index

## Symbols

*OPC .....	414
*OPC? .....	414
*RST .....	424
*WAI .....	414
&GTL .....	390
&GTR .....	390
&LLO .....	390
50 - Extern reference out of range or disconnected .....	678
140 - This modulation forces other modulations off .....	678
180 - Adjustment failed .....	678
182 - Adjustment data missing .....	678
183 - Adjustment data invalid .....	678
200 - Cannot access hardware .....	678
201 - Hardware revision out of date .....	678
202 - Cannot access the EEPROM .....	678
203 - Invalid EEPROM data .....	679
204 - river initialization failed .....	679
241 - No current list .....	679
242 - Unknown list type specified .....	679
261 - Waveform Protected .....	679
460 - Cannot open file .....	679
461 - Cannot write file .....	679
462 - Cannot read file .....	679
463 - Filename missing .....	679
464 - Invalid filename extension .....	679
465 - File contains invalid data .....	679

## A

Abort button .....	115
Abort calculation .....	115
AC supply .....	27
Accept	
Security Settings .....	160
Accept - MCCW .....	359
Accept Carrier Table - MCCW .....	359
Access denied .....	106
Accurate level measurement	
Measurement period .....	368
Additional White Gaussian Noise (option R&S AMU-K62) .....	79
Additive Noise .....	228, 229
Adjust All .....	141
Adjust Baseband Input .....	142
Adjust DAC board .....	464
Adjust DAC Board .....	141
Adjust DAC Board Extension .....	141
Adjustment active	
Reference oscillator .....	140
Adjustment frequency	
Reference oscillator .....	140
Adjustment Path A/B .....	141
Adjustments	
All .....	141
Amplitude	
Annotation (setup security) .....	160
Amplitude of test signal .....	322
Analog I/Q Output Load Type-I/Q OUT .....	644
Angle alpha .....	275
Annotation	
Amplitude (security) .....	160
Frequency (security) .....	160

Append .....	332, 339
Append Blank .....	333
Application cards .....	16
Application notes .....	16
Apply Assistant Settings .....	351, 533
ARB	
Required options .....	296
ARB Multi Carrier	
carrier frequency .....	352
conflict .....	353, 527
mode .....	343, 526
ARB sequencer mode .....	325
ARbitrary Waveform Generator .....	296
Architecture of the instrument .....	71
Arm .....	310, 363
Arm Trigger .....	510
DM .....	292
Armed_Auto .....	309, 517
DM .....	291
Armed_Retrigger .....	309, 517
DM .....	291
Arrow keys .....	24
ASK Depth .....	275
Assemblies display .....	142
ATN .....	683
Attention .....	683
Attenuation	
DM .....	289
Auto .....	309, 517
DM .....	291
Auto Level Set .....	374
Auto Level Set - Baseband Input .....	628
Autonegotiation	
Failed .....	680
AUX I/O interface .....	154
Auxiliary information .....	211
Avoiding signal gaps .....	329
Avoiding wrap-around .....	329

## B

B x T	
DM .....	278
Bandwidth	
DM .....	278
Baseband block menu .....	236
Baseband generator (option R&S AMU-B9/B10/B11) .....	78
Baseband In - Crest-Faktor .....	629
Baseband Input .....	370
Baseband Input - EX-IQ-BOX Settings .....	372
Baseband input module (option R&S AMU-B17) .....	78
Baseband main module (option R&S AMU-B13) .....	79
Baseband section .....	78
Baseband Trigger Input Slope .....	150
BBIN Get Rx Bit Error Selftest .....	670
Bias - I/Q out .....	215
Binary data	
Edit, rules .....	453
Bit energy to noise power density .....	231
Bit Error Rate Measurement .....	189, 453
Bit Rate - AWGN .....	230
BITCLK .....	686
BLER Type .....	206

- Block Error Rate Measurement ..... 189, 453
- Boolean parameters ..... 409
- Brochures ..... 16
- Browser settings
  - LXI ..... 62
- BURST ..... 685
- Burst gate ..... 250
- BURST\_GATE\_A ..... 685
- BURST\_GATE\_B ..... 686
- BUSY ..... 676
- C**
- Carrier + Interferer PEP ..... 232
- Carrier + Interferer Power ..... 232
- Carrier + Noise PEP ..... 232
- Carrier + Noise Power ..... 232
- Carrier Delay ..... 352
- Carrier frequency ..... 352
- Carrier Gain ..... 352
- Carrier Graph ..... 348
- Carrier Graph - MCCW ..... 360
- Carrier Index ..... 352
- Carrier leakage ..... 224
- Carrier spacing
  - Depends on ..... 344
- Carrier Spacing ..... 526
- Carrier Spacing - MCCW ..... 357
- Carrier Start ..... 350, 535
- Carrier Start - MCCW ..... 358
- Carrier State ..... 350, 352, 536
- Carrier State - MCCW ..... 358
- Carrier Stop ..... 350, 535
- Carrier Stop - MCCW ..... 358
- Carrier table ..... 347
- Carrier Table - MCCW ..... 359
- Carrier Table Assistant ..... 350, 535
- Carrier Table Assistant - MCCW ..... 358
- Carrier/Noise Ratio ..... 230
- Case-sensitivity
  - SCPI ..... 405
- CCDF display ..... 187
- Change password
  - Setup (security) ..... 159
- Channel x ..... 318
- Check front panel ..... 147
  - Performing ..... 147
  - Settings ..... 147
- Clear status
  - Remote ..... 426
- Clipping ..... 345
- Clock Frequency ..... 306
- Clock Input Slope ..... 150
- Clock Mode ..... 320, 366, 508
  - DM ..... 295
- Clock Multiplier ..... 320, 366, 508
  - DM ..... 296
- Clock Output Mode ..... 150
- Clock output source ..... 150
- Clock Parameter ..... 319
- Clock rate ..... 306, 332
- Clock rate mode ..... 333
- Clock Reference ..... 245
- Clock Slope ..... 199, 207
- Clock Source ..... 319, 366, 509
  - DM ..... 295
- Coding
  - DM ..... 274
- Colon ..... 410
- Comma ..... 410
- Command sequence
  - recommendation ..... 424
  - Remote ..... 430
- Commands ..... 383
  - Colon ..... 410
  - Comma ..... 410
  - Command line structure ..... 410
  - Common ..... 383
  - Double dagger ..... 410
  - GBIP, addressed ..... 387
  - GBIP, universal ..... 387
  - Instrument control ..... 383
  - Overlapping ..... 412
  - Question mark ..... 410
  - Quotation mark ..... 410
  - SCPI confirmed ..... 383
  - Sequential ..... 412
  - Syntax elements ..... 410
  - White space ..... 410
- Comment ..... 335
- Common commands
  - Syntax ..... 404
- Computer name
  - Changing ..... 46
- CONDition ..... 418
- Configuration list
  - Multi segment waveform ..... 326
- Configure Control Signal ..... 285
- Confirm user password
  - Setup (security) ..... 159
- Conflict ..... 353, 527
- Connected device ..... 376
- Connected device - Baseband Input ..... 628
- Connected device - Digital I/Q Output Settings ..... 222
- Connection to an external controller ..... 48
- Connector
  - AUX I/O ..... 31
  - Baseband digital input ..... 31
  - Baseband digital output ..... 31
  - BERT ..... 31
  - CLOCK ..... 25
  - CLOCK IN ..... 30
  - CLOCK OUT ..... 30
  - DATA ..... 25
  - DATA IN ..... 29
  - DATA OUT ..... 29
  - GPIB ..... 28
  - I ..... 25
  - I BAR ..... 25
  - I BAR OUT ..... 28
  - I IN ..... 28
  - I OUT ..... 28
  - IEC/IEEE ..... 28
  - INSTR TRIG ..... 28
  - LAN ..... 27
  - MARKER 1A, 2A ..... 26
  - MARKER 1A/2A, 1B/2B ..... 29
  - Monitor ..... 30
  - Q ..... 25
  - Q BAR ..... 25
  - Q BAR OUT ..... 28
  - Q IN ..... 28
  - Q OUT ..... 28

- REF IN ..... 29
  - REF OUT ..... 29
  - RESERVE ..... 28
  - TRIGGER 1 ..... 26
  - TRIGGER 1, 2 ..... 30
  - USB ..... 26
  - USB type A ..... 31
  - USB type B ..... 31
  - USER ..... 28
  - Const I/Q test signal ..... 298
  - Const IQ Test Signal ..... 323
  - Constellation diagram ..... 185
  - Control bus ..... 683
  - Control list
    - Edit, rules ..... 453
    - Select, edit, new ..... 173
  - Control Lists
    - DM ..... 280
  - Control signals ..... 249
  - Controller, external ..... 48
  - Copy
    - Several files ..... 176
  - Copy instrument settings ..... 175
  - Copy, data editor ..... 283
  - Counter ..... 142, 467, 468
  - Couple I/Q Bias ..... 215
  - CRC Order ..... 206
  - Create
    - Multi carrier waveforms ..... 341
  - Create and Load ..... 336, 349
  - Create multi segment waveforms ..... 324
  - Create New Directory ..... 175
  - Crest factor
    - Match ..... 368
  - Crest Factor ..... 374
  - Crest factor - Analog I/Q Output Settings ..... 643
  - Crest factor - baseband ..... 233
  - Crest factor - Baseband Signal Power Measurement ..... 235
  - Crest Factor - Basisband In ..... 629
  - Crest Factor - MCCW ..... 357
  - Crest Factor Mode ..... 344, 529
  - Current range without recalculation ..... 295
  - Current Range without Recalculation ..... 319, 366, 513
  - Current Segment ..... 313
  - Cursor keys ..... 24
  - Cursor Length ..... 285
  - Cursor Position ..... 286
  - Cut ..... 175
  - Cut Off Frequency Factor ..... 278
  - Cut, data editor ..... 283
  - CW (continuous wave) ..... 249
  - CW Interferer ..... 228
  - CW Mode ..... 685
  - CW Switching ..... 277
  - CW/Mod ..... 250
- D**
- DATA ..... 685
  - Data Bits ..... 195
  - Data Enable ..... 200, 207
  - Data list
    - Edit, rules ..... 453
    - Select, edit, new ..... 173
  - Data List ..... 243
  - Data Lists
    - DM ..... 280
  - Data pattern
    - DM ..... 271
  - Data Polarity ..... 199, 207
  - Data sheet ..... 16
  - Data Source
    - DM ..... 271
  - Data Valid ..... 683
  - DAV ..... 683
  - DCL ..... 387
  - DEF ..... 408
  - Default instrument settings ..... 38, 136, 431
  - Default settings ..... 304, 342
    - DM ..... 269
  - Default settings - MCCW ..... 355
  - Default values
    - Remote ..... 428
  - Delay
    - Marker ..... 295
  - Delay - Falling Edge of Ramp Envelope ..... 289
  - Delay - Rising Edge of Ramp Envelope ..... 289
  - Delay - Trigger
    - DM ..... 293
  - Delay Start ..... 351, 527, 533
  - Delay Step ..... 351, 532
  - Delete ..... 332, 339
  - Delete instrument settings ..... 175, 491
  - Desired Crest Factor - MCCW ..... 358
  - Destination - Hardcopy ..... 163
  - Deviation
    - FSK Modulation ..... 275
    - Variable FSK Modulation ..... 277
  - Device ID ..... 145
  - Device-specific commands ..... 383
  - Device-specific error messages ..... 678
  - DHCP ..... 45
  - DHCP server
    - LAN configuration ..... 46
  - Differential coding
    - DM ..... 274
  - Differential output module (option R&S AMU-B16) ..... 80
  - Differential settings storing ..... 169, 271
  - DIG IQ Auto Setting ..... 373
  - Digital I/Q Output - EX-IQ-BOX Settings ..... 218
  - Digital I/Q Output peak level - I/Q OUT ..... 220
  - Digital I/Q Output Peak Level - I/Q OUT ..... 220
  - Digital I/Q Output Power-On State - I/Q OUT ..... 222
  - Digital I/Q Output State - I/Q OUT ..... 218
  - Digital I/Q Output Step width - I/Q OUT ..... 221
  - Digital I/Q Output Variation Active - I/Q OUT ..... 221
  - Digital I/Q Output Variation Step - I/Q OUT ..... 221
  - Digital output module (option R&S AMU-B18) ..... 80
  - Display ..... 100
  - Display I/Q Output ..... 210
  - Display I/Q Output - Auxiliary Information ..... 640
  - Display I/Q Output Level Via ..... 211, 219
  - Display I/Q Output Type - I/Q OUT ..... 639
  - Display Output Results - AWGN ..... 229
  - DISPlay subsystem ..... 468
  - DNS server
    - LAN configuration ..... 46
  - Documentation Overview ..... 15
  - Double dagger ..... 410
  - DOWN ..... 408
  - Duration
    - Measurement period external digital signal ..... 368
  - Duration - Baseband Signal Power Measurement ..... 234



**E**

Edge form of ramp envelope	
DM	288
Edge slope of ramp envelope	289
Edit	
Binary data	453
Electrostatic discharge	33
EMI suppression	33
ENABLE	418
Enable registers	
Remote	428
Enter License Key	145
EOI	683
Error log	680
Error messages	102, 675
Adjustment data invalid (183)	678
Adjustment data missing (182)	678
Adjustment failed (180)	678
Cannot access hardware (200)	678
Cannot access the EEPROM (202)	678
Cannot open file (460)	679
Cannot read file (462)	679
Cannot write file (461)	679
Driver initialization failed (204)	679
Extern reference out of range or disconnected (50)	678
File contains invalid data (465)	679
Filename missing (463)	679
Hardware revision out of date (201)	678
Invalid EEPROM data (203)	679
Invalid filename extension (464)	679
No current list (241)	679
This modulation forces other modulations off (140)	678
Unknown list type specified (242)	679
Waveform Protected (261)	679
Error Messages	677
device-specific	678
SCPI	677
Error messages - display list	663
Error queue	419
Error queue query	661, 662
Error queues	
recommendations	424
Errors	196, 203
ESD	33
ESE (event status enable register)	420
ESR	417
ESR (event status register)	420
EVENT	418
Event status enable register (ESE)	420
Remote	426
Event status register (ESR)	420
Remote	426
EX-IQ-BOX Settings	372
EX-IQ-BOX Settings - Digital I/Q Output	218
Examples of application	74
Execute BBIN A/B Selftest	670
Execute Next Segment	318, 554
Execute Trigger	280, 306, 310, 363, 510
Execute:Baseband Connection Selftest	669
Execute:Fader Selftest	671
Expiration date of option	144
Export Deactivation Response	145
EXT REF	675
External frequency	
Reference oscillator	140
External modulation data	244

External Restart	200
External Trigger Delay	
DM	293
Eye diagram	186

**F**

Factory Preset	161
Fading module (option R&S AMU-B14)	79
Fall Delay	289
Fast Save	169, 271
FHOP_CLK	685
FHOP_DATA	685
FHOP_STRB	686
FIFO Status	373
FIFO Status - Baseband Input	635
FIFO Status - Digital I/Q Output Settings	219
FIFO Status - OK	219
FIFO Status - Overflow	219
FIFO Status - Underrun	219
File	353
File - Hardcopy dialog	163
File list	488
File Management	304
File menu	
Save/Recall	168
File Name - Hardcopy	163, 164
File setup - Hardcopy	164
File size	536
File type selection	174
Filter	
DM	278
Filter Cut Off Frequency	345
Filter parameter	
Impact	265
Filter Parameter	
DM	278
Firmware version	143
Fix marker delay to current range	295, 319, 366, 512
Floating licences	144
FM-DC mode	137
Frequency	
Annotation (setup security)	160
Frequency - Test Signal ARB	321
Frequency display	100
Frequency of test signal	322
Frequency Offset	237, 376
Front panel key emulation	131
Front panel test	
Performing	147
FSK Deviation	275
FSK Type (Variable FSK)	277
Fuses	36

**G**

Gain	528
Impairment	223
Gain Imbalance	223, 375
Gain Imbalance - Baseband In	630
Gain Start	350
Gain Step	350
Generate Signal HD	322, 323, 324, 521
Generate Signal HD - Test Signal	521
Generate Signal HD - Test Signal ARB	521
Generate Signal RAM	322, 323, 324, 521
Generate Signal RAM - Test Signal ARB	521



- GET ..... 387
- Getting started ..... 71
- Global Trigger/Clock Settings ..... 320, 367
- Global Trigger/Clock/External Input Settings ..... 148
- Goto local
  - Remote channel settings ..... 155
- GPIB ..... 155
  - bus address ..... 155
  - Characteristics ..... 386
  - interface messages ..... 387
  - Remote control interface ..... 381
- GPIB address ..... 388
- Graphical display of output signal ..... 177
- Graphics block ..... 177
- GTL ..... 387
- H**
- Hardcopy - Destination ..... 163, 474
- Hardcopy - File setup ..... 164
- Hardcopy Device Size ..... 480
- Hardcopy dialog - File ..... 163
- Hardcopy Format ..... 479
- Hardware Config ..... 142
- Hardware options ..... 143
- HDD Streaming ..... 306
- HiSLIP
  - Protocol ..... 385
  - Resource string ..... 384
- HOP (hopping) ..... 152
- I**
- I Offset ..... 224, 375
- I Offset - Baseband In ..... 631
- I Value - Test Signal ARB ..... 323
- I/Q diagram ..... 183
- I/Q Out OFF ..... 676
- I/Q output analog
  - Level Vrms ..... 214
  - load type ..... 214
  - Pep Vp ..... 214
  - power-on state ..... 217
  - set level via ..... 214
  - state ..... 212
  - variation active ..... 215
  - variation step ..... 215
- I/Q Swap ..... 210
- I/Q-Skew ..... 375
- I/Q-Skew - Baseband Input ..... 634
- I/Q-Swap ..... 372
- I/Q-Swap - Baseband Input ..... 630
- I/Q-Swap - I/Q Out Settings ..... 641
- I/QOutput Type - I/Q out ..... 213
- Identification
  - Remote ..... 427
- IFC ..... 387, 683
- Imbalance
  - I/Q digital ..... 226
- Impairments digital ..... 225, 234, 600
- Impedance ..... 199, 207
- Impedance Data Input (ser/par) ..... 149
- Impedance trigger/control signal input (ser/par) ..... 149
- Import License Key ..... 145
- INF ..... 408
- INFO key ..... 102
- Input
  - BURST ..... 685
  - CW Mode ..... 685
  - DATA ..... 685
  - LEV-ATT ..... 685
  - USER 2 ..... 686
  - USER 3 ..... 685
  - USER 4 ..... 685
- Input connector ..... 25, 26, 28, 29, 30, 31
- Input Waveform File ..... 351
- Insertion loss - Analog I/Q Output Settings ..... 644
- Installed Assembly ..... 142
- Instrument Config ..... 142
- Instrument messages ..... 382
- Instrument settings
  - Recall ..... 170, 428, 492
  - Save ..... 168, 429, 493
- Instrument Trigger ..... 150
- Interface
  - functions (GPIB bus) ..... 684
- Interface - AUX I/O ..... 154
- Interface Clear ..... 683
- Interface messages ..... 382, 386
- Interfaces
  - GPIB ..... 386
- Internal adjustments
  - Setup ..... 140
- Interrupt ..... 422
- IP address ..... 384
  - Changing ..... 45
  - Not recognized ..... 680
  - Remote Desktop ..... 52
- IST ..... 417
- IST flag
  - Remote ..... 427
- K**
- Key
  - Arrow key ..... 25
  - BACKSPACE ..... 24
  - BASEBD LEVEL ..... 22
  - BASEBD ON/OFF ..... 22
  - CLOSE ..... 23
  - Cursor key ..... 25
  - DIAGRAM ..... 22
  - ENTER ..... 24
  - ESC ..... 22
  - FILE ..... 22, 167
  - HCOPY ..... 20
  - HELP ..... 20
  - HIDE ..... 23
  - INFO ..... 20
  - INSERT ..... 24
  - LOCAL ..... 20
  - MENU ..... 23
  - ON/OFF ..... 22
  - PRESET ..... 20, 38, 136
  - REARR ..... 23
  - RECALCULATE ..... 22
  - SETUP ..... 20, 137
  - TOGGLE ..... 22
  - WINBAR ..... 23
- Key - HELP ..... 166
- Key - LOCAL ..... 162
- Key combinations ..... 129

- Keyboard
  - Layout ..... 151
- Keyboard emulation ..... 131
- Keyboard Language ..... 482
- Keypad ..... 23
- Keywords
  - see Mnemonics ..... 404
- L**
- LAN
  - Configuration ..... 43
  - Interface ..... 383
  - IP address ..... 384
  - Remote control interface ..... 381
  - VISA ..... 384
  - VXI protocol ..... 385
- LAN connection
  - Setup ..... 160
- LAN Status - LXI ..... 156
- Language Keyboard ..... 482
- Layout
  - Keyboard ..... 151
- Leakage
  - I/Q digital ..... 226
- Leakage - I/Q digital ..... 599
- Lev Att
  - see Level attenuation ..... 250
- LEV ATT ..... 685
- Level attenuation ..... 250
- Level Attenuation
  - DM ..... 289
- Level display ..... 100
- Level mode ..... 333
- Level mode - ARB ..... 549
- Licence for software option ..... 144
- License Key ..... 144
- Linux controller ..... 53
- List Management
  - DM ..... 272
- LLO ..... 387
- Load instrument settings ..... 170, 428, 492
- Load list ..... 335
- Load Sequencing List ..... 339
- Load Waveform ..... 304
- LOC-LLO ..... 676
- Local to remote switchover ..... 389, 390
- Login
  - Operating system ..... 43
- LXI ..... 156
  - Browser interface ..... 62
  - Browser settings ..... 62
  - Configuration ..... 60
  - LAN configuration ..... 64
  - Ping ..... 66
  - Remote trace (SCPI) ..... 68
  - Web Control ..... 67
- M**
- Maintenance ..... 140
- Malfunctions
  - reacting ..... 424
- Manual Remote Control ..... 48
- Manual trigger ..... 280
- Manual Trigger ..... 306, 510
- Map output connector user x to ..... 154
- Marker ..... 254
- MARKER 3A ..... 685
- MARKER 3B ..... 685
- Marker CH x ..... 518
- Marker Channel x
  - DM ..... 294
- Marker Delay ..... 295
- Marker Mode ..... 318, 365
- Marker output signals ..... 253
- Marker Pattern ..... 520
- Marker Positions ..... 286
- Marker trace
  - Periodical ..... 437
- Marker x Delay ..... 319, 365
- Matching
  - Crest factor ..... 368
- MAX ..... 408
- Max Data Bits ..... 198
- Max Errors ..... 198, 206
- Max Received Blocks ..... 206
- Measured external clock ..... 320, 366
- Measured External Clock ..... 296
- Measurement period
  - How long ..... 368
- Measurement Period ..... 374
- Measurement Period - Baseband Input ..... 631
- Menu structure
  - Access denied ..... 106
  - Header ..... 106
  - Menu area ..... 106
- Messages
  - Commands ..... 383
  - Instrument ..... 382
  - Instrument responses ..... 383
  - Interface ..... 382
- MIMO fading power correction
  - Baseband signal power measurement ..... 235
- MIN ..... 408
- Minimum Noise/System Bandwidth Ratio - AWGN ..... 228
- Mnemonics ..... 404
  - Optional ..... 406
- Mode ..... 198, 205, 343, 526
- Modular design ..... 71
- Modulation
  - DM ..... 276
- Modulation data external ..... 244
- Modulation Delay for ext. Data ..... 277
- Modulation Type
  - DM ..... 275
- Multi Carrier CW ..... 354, 600
- Multi carrier waveforms ..... 341
- Multi Segment table ..... 331
- Multi segment waveform sequencing ..... 325
- Multi Segment Waveforms ..... 324
- Multiple files
  - Copy ..... 176
- Multiplier ..... 508
  - DM ..... 296
- N**
- NAN ..... 408
- Navigation keys ..... 24
- NDAC ..... 683
- Network
  - Connection fails ..... 680
- New list ..... 336

- New password  
  Setup (security) ..... 159
- New Sequencing List ..... 339
- Next Segment ..... 313
- Next Segment Mode ..... 313
- NINF ..... 408
- No Clock BERT ..... 196
- No Clock BLER ..... 204
- No Sync BERT ..... 196
- No Sync BLER ..... 204
- Noise Bandwidth - AWGN ..... 229
- Noise generator, switching on ..... 228
- Noise Only ..... 228, 229
- Noise power - AWGN ..... 231
- Noise power Total Bandwidth - AWGN ..... 232
- NRFD ..... 683
- NTRansition ..... 418
- Number of Carriers ..... 344
- Number of Carriers - MCCW ..... 356
- Number of licences ..... 144
- Numeric values  
  Special ..... 408
- O**
- Offset - I/Q out ..... 216
- Offset DC ..... 323
- Old password  
  Setup (security) ..... 159
- ON/OFF Ratio Marker ..... 255, 318, 519  
  DM ..... 294
- Online help ..... 15  
  Working with ..... 121
- Online manual ..... 15
- Operating concept ..... 71
- Operating manual ..... 15
- Operating system ..... 42  
  Login ..... 43  
  service packs ..... 43
- Operation complete  
  Remote ..... 427
- Operation hours ..... 142, 467, 468
- Optimize Crest Factor ..... 344, 529
- Optimize Crest Factor - MCCW ..... 357
- Option  
  ARB Baseband Generator ..... 296  
  Baseband Generator (B9/B10/B11) ..... 235  
  Baseband Main Module (B13) ..... 235  
  Hardware ..... 143  
  R&S AMU-B9/B10/B11 (Baseband Generator) ..... 367  
  R&S AMU-B13 (Baseband Main Module) ..... 367  
  R&S AMU-B17 (Baseband I/Q Input) ..... 367  
  R&S SMBV-K18 (Digital Baseband Connectivity) ..... 217  
  Software ..... 143
- Option: expiration date ..... 144
- Options  
  Identification (remote) ..... 427
- Options - Hardcopy ..... 163
- Orientation- Hardcopy ..... 481
- Oscillator  
  Reference ..... 137  
  Source (reference) ..... 139
- Output  
  BITCLK ..... 686  
  BURST ..... 685  
  DATA ..... 685  
  LEV-ATT ..... 685
- MARKER 3A ..... 685
- MARKER 3B ..... 685
- SYMBCLK ..... 686
- USER 2 ..... 686
- USER 3 ..... 685
- USER 4 ..... 685
- Output connector ..... 25, 26, 28, 29, 30, 31
- Output file  
  Multi segment waveform ..... 326
- Output File ..... 335, 348
- Output queue ..... 417
- Overflow - Digital I/Q Output Settings ..... 221
- Overflow Hold - Digital I/Q Output Settings ..... 221
- Overlapping commands ..... 412  
  Preventing ..... 414
- Overload ..... 376
- Overload - Basisband In ..... 632
- Overload Hold ..... 376
- Overload Hold - Basisband In ..... 632
- Oversampling ..... 574  
  DM ..... 278
- Oversampling Auto State ..... 574
- Oversampling factor ..... 300
- P**
- Packing ..... 673
- Paper size - Hardcopy ..... 482
- Parallel poll register enable  
  Remote ..... 428
- Parameters  
  Block data ..... 410  
  Boolean ..... 409  
  SCPI ..... 407  
  Special numeric values ..... 408  
  String ..... 410  
  Text ..... 409  
  Units ..... 408
- Part numbers ..... 142
- Password  
  Change (security password) ..... 159  
  Confirm (security password) ..... 159  
  New (security password) ..... 159  
  Old (security password) ..... 159  
  Remote Desktop ..... 52
- Paste ..... 175
- Paste, data editor ..... 283
- Path Gain ..... 239, 377
- Path reset ..... 431
- Pattern  
  DM ..... 271
- Pattern Ignore ..... 201
- PCI bus ..... 142
- Peak envelope power PEP ..... 101
- Peak Level ..... 374
- Peak Level - Baseband Input ..... 633
- Peak power - Baseband Signal Power Measurement ..... 235
- Peak power of baseband ..... 233
- Peak value ratio - Analog I/Q Output Settings ..... 644
- Period ..... 332
- Periodical  
  Marker trace ..... 437
- Periodical markers ..... 445
- Phase Offset ..... 238
- Phase Offset Q - Test Signal ..... 524
- Phase Offset Q - Test Signal ARB ..... 321
- Phase Start ..... 351, 528

- Phase Start - MCCW ..... 358
  - Phase Step ..... 351, 534
  - Phase Step - MCCW ..... 359
  - Ping
    - LXI ..... 66
  - Play list ..... 318, 326, 336, 337
  - Play list file
    - Sequencing list file ..... 326
  - Playlist
    - See play list ..... 326
  - Point-to-point connection ..... 44
  - Polarity - No signal (blank) marker ..... 154
  - Power ..... 233
  - Power - AWGN ..... 231
  - Power - Baseband Signal Power Measurement ..... 235
  - Power of starting carrier ..... 350, 528
  - Power of starting carrier - MCCW ..... 358
  - Power ramping ..... 250
    - DM ..... 288
  - Power reference ..... 346
  - Power spectrum ..... 188
  - Power Start ..... 528
  - Power Start - MCCW ..... 358
  - Power Step ..... 534
  - Power Step - MCCW ..... 358
  - Power-On Count ..... 142
  - Power-On Counter ..... 468
  - Power-On State - I/Q OUT ..... 645
  - PPC ..... 387
  - PPE ..... 417
  - PPU ..... 387
  - PRBS ..... 199
  - PRBS generator ..... 243
  - PRBS Type
    - DM ..... 271
  - Preset ..... 38
  - Preset - instrument settings ..... 136
  - Preset instrument settings ..... 38, 431
  - Protection ..... 157
  - Protocol
    - VXI ..... 385
  - PTRansition ..... 418
  - Pulse Divider Marker ..... 254, 318, 520
    - DM ..... 294
  - Pulse Frequency Marker ..... 254, 318, 520
    - DM ..... 294
- Q**
- Q Offset ..... 224, 375
  - Q Offset - Baseband In ..... 631
  - Q Value - Test Signal ARB ..... 323
  - Quadrature Offset ..... 224
  - Quadrature Offset - I/Q digital ..... 226, 600
  - Queries ..... 383, 411
    - Status ..... 423
  - Question mark ..... 410, 411
  - Questionable status register ..... 421
  - Quick Start Guide ..... 15
  - Quotation mark ..... 410
- R**
- Rackmounting ..... 36
  - Ramp Function ..... 288
  - Ramp Time ..... 289
  - Ratio Noise/System Bandwidth - AWGN ..... 228
  - Recall instrument settings ..... 170, 171, 428, 492
  - Recall intermediate ..... 428
  - Recall Intermediate ..... 171
  - Received Blocks ..... 203
  - Recommendations
    - remote control programming ..... 424
  - Rect test signal ..... 298
  - Rect Test Signal ..... 322
  - Reference
    - Source (oscillator) ..... 139
  - Reference frequency
    - External ..... 140
  - Reference oscillator ..... 137
    - Adjustment active ..... 140
    - Adjustment frequency ..... 140
    - External frequency ..... 140
    - Settings ..... 139
    - Source ..... 139
  - Registers ..... 417
  - Release notes ..... 16
  - REM-LLO ..... 676
  - Remaining Time - Baseband Signal Power Measurement ..... 234
  - REMOTE ..... 676
  - Remote access ..... 48
  - Remote channel
    - GPIB address ..... 155
  - Remote channel settings ..... 155
    - Goto local ..... 155
    - GPIB resource (VISA resource string) ..... 155
    - HILSIP resource (VISA resource string) ..... 155
    - Network resource (Ethernet resource string) ..... 155
    - Serial ..... 155
    - Socket resource (VISA resource string) ..... 155
    - USB VISA resource string ..... 155
  - Remote control
    - Basics ..... 381
    - GPIB address ..... 388
    - Interfaces ..... 381
    - Protocols ..... 381
  - Remote Control
    - GPIB ..... 391
  - Remote control switchover ..... 389
  - Remote Desktop ..... 50
  - Remote operation ..... 50
  - Remote trace
    - LXI ..... 68
  - Removing sensitive data ..... 680
  - REN ..... 683
  - Rename ..... 175
    - File ..... 492
  - Required options
    - ARB ..... 296
  - Resampling
    - External baseband signal ..... 368
  - Resart Marker ..... 334
  - Reserve connector ..... 28
  - Reset ..... 376
    - Reset - Baseband In ..... 631
    - Reset - Digital I/Q Output Settings ..... 221
    - Reset instrument settings ..... 38, 136, 431
    - Reset path ..... 431
    - Reset values
      - Remote ..... 428
  - Result ..... 195, 203
  - Resulting CW Frequency - AWGN ..... 229

- Retrigger ..... 309, 517
  - DM ..... 291
- Revisions ..... 142
- RFI signal generator, switching on ..... 228
- Rise Delay ..... 289
- rms Level - Baseband Input ..... 633
- RMS power ..... 374
- Roll off factor
  - DM ..... 278
- Rotary knob ..... 24
- Route to path A/B ..... 239, 377
- Running ..... 310, 362
  - DM ..... 291
- S**
- SAMBA/SMB
  - How to ..... 176
- Sample Rate Sorurce ..... 372
- Sample Rate Source - Baseband Input ..... 635
- Sample Rate Source - Digital I/Q Output Settings ..... 218
- Sample Rate Value ..... 373
- Sample Rate Value- Digital I/Q Output Settings ..... 219
- Samples ..... 332
- Samples per Period ..... 322
- Samples per Period - Test Signal ..... 524
- Samples per Period - Test Signal ARB ..... 321
- Save
  - Control list, DM ..... 287
  - DM ..... 283
- Save As
  - Control list, DM ..... 287
- Save immediate ..... 168
- Save instrument settings ..... 168, 429, 493
- Save intermediate ..... 429
- Save List ..... 335
- Save Sequencing List ..... 339
- Save/Recall ..... 342
- SCPI
  - Parameters ..... 407
  - Syntax ..... 404
  - Version ..... 381
- SCPI - error messages ..... 677
- SCPI confirmed commands ..... 383
- SCPI remote trace
  - LXI ..... 68
- Screen Saver ..... 151
- SDC ..... 387
- Security
  - Accept settings ..... 160
  - Annotation amplitude (setup) ..... 160
  - Annotation frequency (setup) ..... 160
  - Change password (setup) ..... 159
  - Confirm password (setup) ..... 159
  - New password (setup) ..... 159
  - Old password (setup) ..... 159
  - Security password ..... 159
- Security password
  - Security ..... 159
  - Setup ..... 159
- Security Password
  - Setup ..... 160
- Security settings
  - LAN connection ..... 160
- Security Settings
  - Security Password ..... 160
  - USB Device ..... 160
- Segment # ..... 331
- Segment Down ..... 332, 339
- Segment Marker ..... 334
- Segment Up ..... 332, 339
- Select file ..... 173
- Select operation
  - File menu ..... 168
- Select Preset Type ..... 286
- Select Ramp to Edit ..... 285
- Self-test
  - Remote ..... 429
- Selftest
  - BBIN Get Rx Bit Error ..... 670
- Selftest:Execute
  - Fader Selftest ..... 671
- Selftest:Execute BBIN A/B Selftest ..... 670
- Selftest:Execute:Baseband Connection Selftest ..... 669
- Sequencing Graphic ..... 339
- Sequencing List ..... 318, 336, 337
- Sequential commands ..... 412
- Serial bus ..... 142
- Serial numbers ..... 142
- Service manual ..... 16
- Service packs ..... 43
- Service request (SRQ) ..... 419, 422
- Service request enable register (SRE) ..... 419
  - Remote ..... 429
- Set acc. to Standard
  - DM ..... 272
- Set Noise power via ..... 230
- Set to default ..... 304, 342
  - DM ..... 269
- Set to default - MCCW ..... 355
- Setting commands ..... 383
- Setting not possible ..... 106
- Setting parameters ..... 108
- Settings
  - Check front panel ..... 147
  - Reference oscillator ..... 139
- Setup
  - Accept security settings ..... 160
  - Annotation amplitude (security) ..... 160
  - Annotation frequency (security) ..... 160
  - Change password (security) ..... 159
  - Confirm password (security) ..... 159
  - Internal adjustments ..... 140
  - New password (security) ..... 159
  - Old password (security) ..... 159
  - Performing the front panel test ..... 147
  - Security password ..... 159
- Setup key ..... 137
- Signal + Interferer PEP ..... 232
- Signal + Interferer Power ..... 232
- Signal + Noise PEP ..... 232
- Signal + Noise Power ..... 232
- Signal Duration ..... 309, 346, 362
- Signal Duration Unit ..... 309
- Signal Duration Unit - Trigger ..... 515
- Signal Level (RMS) ..... 626
- Signal Period Mode ..... 345
- Signal Routing ..... 239, 377
- Signal/Noise Ratio ..... 230
- Sine test signal ..... 298
- Sine Test Signals ..... 321
- Slope - External baseband trigger ..... 150
- Softkey ..... 105
- Software options ..... 143

- Source
    - Reference oscillator ..... 139
    - Reference Oscillator ..... 656
    - Source - Baseband Signal Power Measurement ..... 234
    - Source Power Ramp Control ..... 288
    - SPD ..... 387
    - SPE ..... 387
  - Special characters
    - SCPI ..... 407
  - Spectrum display ..... 188
  - SRE ..... 417
  - SRE (service request enable register) ..... 419
  - SRQ ..... 683
  - SRQ (service request) ..... 419, 422
  - Standard
    - DM ..... 272
  - Standard settings ..... 304, 342
    - DM ..... 269
  - Standard settings - MCCW ..... 355
  - Standby mode ..... 20
  - Start delay ..... 351, 527
  - Start phase ..... 351, 528
  - Start phase - MCCW ..... 358
  - Start select, data editor ..... 282
  - Start/Stop Display Update ..... 146
  - Starting gain ..... 350
  - Starting power ..... 528
  - Starting power - MCCW ..... 358
  - Startup complete ..... 666
  - State ..... 195, 203, 304, 371
    - Adjustment (reference oscillator) ..... 140
    - DM ..... 269
  - State - AWGN ..... 228
  - State - Baseband Input ..... 635
  - State - Baseband Signal Power Measurement ..... 234
  - State - digital Impairments ..... 225, 600
  - State - I/Q Out ..... 210
  - State - I/Q OUT ..... 641
  - State - MCCW ..... 355
  - State Power Ramp Control ..... 288
  - Status
    - Queries ..... 423
  - Status byte
    - Remote ..... 426, 429
  - Status byte (STB) ..... 419
  - Status information ..... 675
  - Status Information ..... 145
  - status messages
    - BUSY ..... 676
    - I/Q Out OFF ..... 676
  - Status messages
    - EXT REF ..... 675
    - LOC-LLO ..... 676
    - REM-LLO ..... 676
    - REMOTE ..... 676
    - SYS CTRL ..... 676
  - Status registers ..... 417
    - CONDition ..... 418
    - ENABLE ..... 418
    - EVENT ..... 418
    - model ..... 418
    - NTRansition ..... 418
    - parts ..... 418
    - PTRansition ..... 418
  - Status reporting system ..... 415
    - Application ..... 422
    - Common commands ..... 426
  - STB ..... 417
  - Step width - I/Q OUT ..... 647
  - Stopped ..... 310, 362
    - DM ..... 291
  - Storing ..... 673
  - Streaming Buffer ..... 306, 543
  - Suffixes ..... 406
  - Support ..... 680
  - Symantec Antivirus ..... 59
  - SYMBCLK ..... 686
  - Symbol Clock Multiplier
    - DM ..... 296
  - Symbol Rate
    - DM ..... 274
  - Sync. Output to External Trigger ..... 292, 311, 363
  - Syntax elements
    - SCPI ..... 410
  - SYS CTRL ..... 676
  - System Bandwidth - AWGN ..... 228
  - System directory ..... 483
- ## T
- Tag type
    - Clock ..... 434
    - Control length ..... 437
    - Emptytag length ..... 436
    - Level offset ..... 438
    - Magic ..... 433
    - Samples ..... 439
    - Segment count ..... 441
    - Segment length ..... 442
    - Segment start ..... 442
    - Trace list ..... 439
    - Waveform length ..... 440
  - Tag Type ..... 443
    - Comment ..... 434
    - Control List Width4 ..... 444
    - Copyright ..... 435
    - Data Bitlength ..... 435
    - Data List ..... 435
    - Date ..... 436
    - Segment Clock Mode ..... 442
    - Segment Comment ..... 444
    - Segment Files ..... 444
    - Segment Level Offset ..... 444
  - Target Crest Factor ..... 345
  - Target CW Frequency - AWGN ..... 229
  - Test
    - Check front panel ..... 147
  - Test signal
    - ARB generator ..... 298
  - Test Signal ..... 321, 322
  - Threshold ..... 199, 207
  - Threshold data input (ser/par) ..... 149
  - Threshold trigger/control signal input ..... 149
  - Trigger ..... 198, 205
    - BERT ..... 463
    - BLER ..... 463
    - Event (remote) ..... 429
  - Trigger Delay ..... 312, 364
    - Actual ..... 294, 312
    - Expressed in time ..... 293, 311
    - Resulting ..... 294, 312
    - Unit ..... 293, 311
  - Trigger Delay External
    - DM ..... 293

- Trigger Delay Other Baseband
    - DM ..... 293
  - Trigger Example ..... 318
  - Trigger Inhibit ..... 294, 312, 365
  - Trigger Input Slope ..... 150
  - Trigger Mode ..... 309, 517
    - Armed ..... 362
    - Auto ..... 362
    - DM ..... 291
    - Retrigger ..... 362
    - Single ..... 362
  - Trigger parameters
    - DM ..... 289
  - Trigger Signal Duration ..... 291
  - Trigger signals ..... 252
  - Trigger Source ..... 310, 363
    - DM ..... 292
  - Trigger Source - Graphics ..... 179
  - Triggering
    - Multi segment waveform ..... 327
    - Segment ..... 327
  - Troubleshooting ..... 675
- U**
- Ultr@VNC ..... 53
  - Unit ..... 195, 203
  - Units ..... 408
    - Input ..... 23
  - UNIX controller ..... 53
  - Unmodulated signal ..... 250
  - UP ..... 408
  - Up-conversion
    - Important parameters ..... 368
  - Update - Setup System ..... 146
  - USB Device - Setup ..... 160
  - USER 2 ..... 686
  - USER 3 ..... 685
  - USER 4 ..... 685
  - User Clock ..... 334, 548
  - User Filter
    - Catalog ..... 279
    - Delete ..... 279
    - Load ..... 279
  - User ID
    - Remote Desktop ..... 52
  - User Mapping
    - Catalog, DM ..... 275
    - Delete, DM ..... 275
    - Load, DM ..... 275
  - User Marker / AUX I/O Settings ..... 320, 367
- V**
- Variable FSK
    - Deviation ..... 277
  - Variation Active - I/Q OUT ..... 647
  - Variation Step - I/Q OUT ..... 647
  - Vector diagram ..... 184
  - Virus protection ..... 42
  - Virus-Protection Software ..... 59
  - VISA ..... 381, 384
    - Libraries ..... 382
    - Resource string ..... 382, 384
  - VISA resource string
    - Ethernet ..... 155
    - GPIO ..... 155
  - HISLIP ..... 155
    - Serial ..... 155
    - Socket ..... 155
    - USB ..... 155
  - Visual check of signal characteristics ..... 177
  - VNC connection ..... 53
  - Voltage threshold ..... 149
  - VXI protocol ..... 385
- W**
- Wait
    - Remote ..... 430
  - Wait Time ..... 151
  - Warnings ..... 102, 677
  - Waveform
    - Edit, rules ..... 453
    - Maximum length ..... 300
    - optimizing ..... 300
  - Waveform file
    - Corrupted, reasons ..... 453
  - Waveform File ..... 304
  - Waveform Info ..... 305, 331, 339
  - Web Control
    - LXI ..... 67
  - White papers ..... 16
  - White space ..... 410
  - Winbar ..... 105
  - Windows 7 ..... 42
  - Windows Embedded Standard
    - Access ..... 43
- Z**
- Zoom ..... 287